

A large teal triangle graphic that starts at the top left corner and extends diagonally towards the bottom right corner, covering the left and bottom portions of the page.

Sauder Education®

Furniture  
**Price List**

**Sauder Education® Price List 2026 Volume 261.1 | Effective October 1, 2025**

Contact Sauder Education at 800.537.1530 or your local sales representative for appropriate discounts.

## GENERAL INFORMATION

TERMS AND CONDITIONS .....	3-6
WARRANTY AND RENEWABILITY.....	7-8
QUICKSHIP, FABRIC INFO, ADDITIONAL OPTIONS .....	9

## SEATING

ALLURE.....	10
BISTRO .....	10
BRIDGE.....	10
CANYON.....	10
CAVETTO .....	10
CAVETTO OPTIONS .....	10
CHANDLER .....	11
CHILL .....	11
CHILL OPTIONS.....	11
DELTA.....	11-12
DELTA OPTIONS .....	12
ENCORE.....	12
KIRBY.....	12
LATITUDE.....	12
LATITUDE OPTIONS .....	13
MOMENT.....	13
PLYFOLD .....	13
PLYFOLD OPTIONS.....	13
PLYLOK .....	14
PLYLOK OPTIONS.....	14
PLYWEDGE .....	15
PLYWEDGE OPTIONS .....	15
POSE.....	15
PUZZLE .....	15
PUZZLE OPTIONS .....	16
RALLY.....	16-17
RALLY OPTIONS.....	17-18
TREY .....	18
TANNER .....	19
TANNER OPTIONS .....	19
UPLAND.....	19-20
UPLAND OPTIONS .....	20-21

## OCCASIONAL TABLES

4700 SERIES .....	22
4700 SERIES OPTIONS.....	22
ALLY .....	22
AMIGO ROUND/SQUARE.....	22
AMIGO OPTIONS .....	22
DISC ROUND/SQUARE .....	23
DRUM & CUBE.....	23
DRUM & CUBE OPTIONS.....	24
DUNE.....	24
FUSE.....	24
LEGACY .....	24
ROWAN .....	24
TANNER .....	24
TANNER OPTIONS .....	24
TRUMPET ROUND/SQUARE .....	25

## MULTI-PURPOSE TABLES

ALLY .....	26
ALLY OPTIONS .....	26
DISC.....	26-27
FUSE.....	27
FUSE OPTIONS .....	27
ROWAN .....	27
SUMMIT .....	28-29
SUMMIT OPTIONS .....	29
TANNER .....	30
TANNER OPTIONS .....	30
TAPERED LEG .....	30
TRUMPET .....	30
TUBULAR.....	30-32
TUBULAR OPTIONS.....	32-33

## BEDS

CAMDEN .....	34
DURASTAK.....	34
FORGE .....	34
MASON .....	34
MASON OPTIONS.....	34
TRUSTAK .....	35
ZTRAK.....	35
ZTRAK W/ZLOK .....	35
ZTRAK BED SYSTEM COMPONENTS.....	35-36
ZTRAK OPTIONS .....	36
UNIVERSAL BED ACCESSORIES.....	36-36
UNIVERSAL BOX SPRINGS, SPRING BASES, BED PLATFORMS.....	36
UNIVERSAL MATTRESSES.....	36-37

## CASEGOODS, DESKS, AND STORAGE

ENDURE DESKS .....	38
ENDURE STORAGE .....	38
ENDURE STORAGE .....	39
MERIT DESKS.....	39
MERIT DESK OPTIONS.....	39
MERIT STORAGE .....	39
MERIT STORAGE.....	40

# TERMS AND CONDITIONS

## CONTACT INFORMATION

Please contact Sauder Education® with questions or for assistance.

Sauder Education®  
201 Horton Street  
Stryker, OH 43357  
Phone 800.537.1530  
saudereducation.com | sales@saudereducation.com

Sauder Education is a brand of Sauder® Manufacturing Co.

## DEFINITIONS

Company means Sauder® Manufacturing Co., its servants, employees, and agents and includes Sauder® Manufacturing Co; Sauder Worship Seating®; Sauder Education®; Sauder® Courtroom Furniture; Wieland; Butler Human Services®; Sauder® Courtroom Seating; and any affiliated, predecessor or successor entities.

## GENERAL TERMS

### EXCLUSIVE CONTRACT TERMS

These Terms and Conditions shall be deemed incorporated as a part of every contract to purchase goods from the Company. By entering into a purchase contract with the Company and accepting delivery of the goods, Purchaser agrees that these Terms and Conditions are the sole and exclusive statement of all such terms and conditions, that the contract is limited to these terms and conditions, and that any different or additional terms and conditions proposed by Purchaser are objected to and shall not become a part of the contract unless expressly accepted by Company in writing.

### AUTHORIZED DEALERS

Possession of these terms and conditions, product information and/or price list does not imply the right to purchase products illustrated and priced therein. Sales are confined to accounts with credit approval only. A minimum of 30 percent down payment is required on all orders until credit is established.

### APPLICABLE LAW

The Contract shall be governed by the substantive laws of the State of Ohio. The sole and exclusive jurisdiction and venue for the enforcement or any rights or obligations relating to the contract or the goods shall be in the Fulton County, Ohio Court of Common Pleas or the United States District Court for the Northern District of Ohio, and the parties consent to the jurisdiction of these courts as a part of this transaction. The Company shall be entitled to recover its reasonable attorney's fees, costs and expenses in connection with any action taken by Company to enforce the contract (including these Terms and Conditions).

### GOVERNMENT REGULATIONS

Customer shall comply with all applicable governmental laws, codes, and regulations, including building and fire codes applicable to this purchase and including design, type of material and installation arrangements thereof.

## PRICES & PAYMENT TERMS

### PRICES

Published prices are list, FOB destination, per zone destination. Prices do not account for special delivery situations including the following, which are the responsibility of the Purchaser:

- Dedicated delivery appointments
- Lift gate
- Multiple drops on site per shipment
- Multiple shipments per order (that could be accommodated by one delivery)
- Charges for cartons, packaging, and crating, beyond the normal Company shipping methods
- Storage or insurance claims

- Sales and other taxes
- Local delivery, uncrating, and installation (if applicable)

Prices on Order Acknowledgments are net. Company reserves the right to change prices prior to Order Acknowledgment without notice. Company reserves the right to increase prices or any part thereof, if Purchaser delays delivery of the furniture beyond 8 weeks from receipt of any of the following: Order Acknowledgment, signed order contract, receipt of subcontract, and/or receipt of signed purchase order.

In addition to any other right of Company to increase prices as set forth herein, in the event Purchaser, for any reason, directs delivery of goods and services ordered to occur beyond 8 weeks from receipt of any of the following: Order Acknowledgment, signed order contract, receipt of subcontract, and/or receipt of signed purchase order, Purchaser shall bear the risk of and be responsible to pay Company any price increases that may occur in connection with the goods and services ordered as well as storage costs arising from or incurred as a result of same. Company reserves the right to require a non-refundable deposit be paid by Purchaser to Company in the event of the foregoing.

### PERFORMANCE BONDS

If a bond is required, the cost shall be 1% of the total Contract. If a bond is not specifically listed on the Contract it is not included. If a bond is purchased, the bond will only cover substantial completion of the project plus one year of the warranty period.

### TAXES

All sales are subject to sales tax unless a valid sales tax exemption certificate or resale certificate for the ship-to state accompanies the order.

### INVOICING

Product will be invoiced at the time of shipment, or as designated by the Order Acknowledgment. If a partial order is shipped and a back order is created, Purchaser will be invoiced for the portion that shipped.

### TERMS OF PAYMENT, SECURITY INTEREST AND LIEN RIGHTS

Credit will be established based upon Company's determination of credit worthiness. A deposit or prepayment may be required on certain accounts after credit review. Credit terms are 30 days net from date of invoice and/or as designated by the Order Acknowledgment. Company may cancel or change credit terms at its discretion and may request advance payment at any time. No order will be released for production without a credit approval from the Credit Department. Company may at its option, and without notice, raise or allow charges in excess of any credit limit granted. Purchaser understands and agrees that (the Purchaser) is responsible for all charges on the account. All payments due to Company shall be paid without any set-off or claim.

Purchaser agrees to pay a service charge of 1.5 percent per month or as allowed by law on all past due accounts. A past due account is an account that remains unpaid for more than 30 days. Until such time that an account and/or an order is paid in full to the Company, Company shall retain a security interest in and lien on all materials, merchandise, furnishings, and/or goods manufactured, provided, delivered or otherwise on said account and/or order. Company reserves and may exercise any and all rights and remedies with respect to said materials, merchandise, furnishings, and/or goods against the Customer and/or any individual or entity in possession of or claiming an interest in said materials, merchandise, furnishings and/or goods, including but not limited to demanding assembly of the goods at the direction of Company, re-taking possession and selling and applying proceeds of any sale toward the account, and/or filing suit. All charges are payable according to these terms and conditions unless otherwise prearranged and agreed to in writing by Company.

### TITLE & RISK

Title to all goods shall pass from Company to Purchaser upon Company's receipt of payment in full under this Contract or any change thereof.

Risk of loss or damage to the goods becomes the responsibility of Purchaser upon delivery. Unless otherwise specified in writing, Company will determine

Initials \_\_\_\_\_ Date \_\_\_\_\_

# TERMS AND CONDITIONS

the method of shipment and carrier. If products are shipped via Purchaser's choice of carrier, Company is not responsible for damage in shipment.

Purchaser will insure the goods against all insurable risks in the name of Purchaser and also in the name of Sauder Manufacturing Co. as the unpaid vendor for their full insurable value.

## ORDERING & LEAD TIME

### ORDERING

A signed purchase order or contract received via mail, fax or email is required before an order is processed. In addition, credit applications, credit references and/or advance payments may be required for newly established accounts. Orders are not scheduled in production, nor materials purchased, until all details are received.

### ORDER ACKNOWLEDGMENT

Orders are binding upon receipt of the Order Acknowledgment. The Order Acknowledgment, which relates to the acceptance of the order/contract, is sent after the order/contract contemplates pricing changes, if any, delivery dates and/or estimated installation completion. Any and all modifications to the Order Acknowledgment must be reconfirmed and signed by Company.

Acceptance of the Order Acknowledgment shall be evidenced by signature(s) and/or Company commencing work on the project.

Any error or discrepancy on the Order Acknowledgment must be reported to Company in writing within 3 working days from the receipt of the Order Acknowledgment. Cashing a down payment check does not constitute acceptance.

### CHANGE ORDERS

The order as shown on the Order Acknowledgment can be modified only by a written communication or reconfirmation signed by Company and Purchaser.

Company may, at its discretion, accept reasonable change orders with the following conditions:

- The request for change must be submitted in writing and received before order specific parts have been purchased and/or the manufacturing process has begun.
- Changes may be subject to additional charges for material, labor, restocking, and administrative costs.
- Changes may result in an extended delivery date.

### CANCELLATIONS

Any deposit made with respect to the order is non-refundable. Company reserves the right to cancel any order, with notice to Purchaser, due to breach of obligation or contract. Additionally, if an order is canceled after order specific materials have been purchased and/or production has started, Purchaser will be responsible for the cost associated with those materials or production. Any Customer's Own Material (COM) supplied will be returned "as-is". This applies to any fabric that has been cut, wood parts with a finish applied, and all laminates. A cancellation or restocking charge of 1/3 of the net sale is applicable on orders canceled.

### LEAD TIME

Lead times will vary based on specifications chosen and available manufacturing capacity. Consult your authorized sales representative or the home office when placing your order to determine estimated ship date.

### DRAWINGS

The drawing(s) are a key component in determining final quantities and layouts for goods requiring installation. The Final Signed Drawing shall be considered a legal and binding part of the Contract. Changes to the Final Signed Drawing can only be made through written communication to Company or reconfirmation signed by Company and Purchaser. Changes requested may incur additional costs and/or delivery delays.

### CUSTOM PRODUCTS AND MATERIALS

All nonstandard designs and materials are subject to a surcharge; contact Company for approval and pricing. The use of nonstandard designs and/or

materials may cause extended delivery times and reduced warranty coverage.

- Within our standard offering, an upcharge may be applied if a premium pattern or finish is selected. This may also cause extended lead times.

### CUSTOMER'S OWN MATERIAL (COM)

Please contact Company on all COM fabrics. A sample of the COM fabric is required to be submitted to Company for approval and yardage estimate prior to placing an order. The sample should be large enough to indicate a repeat if applicable.

Yardage requirements will be calculated based on a variety of factors including roll width, pattern matching and direction. If a fabric is directional, it will be applied vertically unless specific instructions are given to the contrary. If a horizontal application is desired, please inform Company as additional yardage or special production techniques may be required. At Purchaser's request, Company may, in its discretion, for non-Company program fabrics handle the purchase of the COM fabric for a charge of 20 percent of the fabric list price.

Company reserves the right of preliminary approval for all COM prior to order acceptance. Even after such preliminary approval, Company reserves the right to reject COM if, upon physical inspection of the material, it proves unacceptable for use on Company products. When COM is accepted, Company assumes no responsibility for appearance, durability, color fastness, or any other quality after it is Upholstered on a Company product.

Orders with COM are not scheduled into production until all materials are received and inspected. If partial shipment entry is required, indicate on purchase order, or forward orders with standard products and COM products on separate purchase orders. Shipping address:

Sauder Manufacturing Co.  
C/O Sauder Education  
10785 Rose Avenue  
New Haven, IN 46774-9246

However, any verification of compliance of COM materials with TB117-2013 is the responsibility of the person specifying the COM material.

## PRODUCT DESIGN, COMPLIANCE & SAFETY

### PRODUCT DESIGN

Company reserves the right to make changes in design and construction or discontinue products without prior notice.

### COMPLIANCE

Products offered by Company do comply with the requirements of local, state and national fire codes. The products offered as a base are manufactured with resilient filling materials and textiles in compliance with California Technical Bulletin TB117-2013.

### THE TOXIC SUBSTANCES CONTROL ACT

Enforced by the EPS, TSCA a law enacted in 1976 regulates chemical substances and mixtures in commerce. Products offered comply with all applicable rules or orders under the TSCA, and no chemical substances in violation of the TSCA are offered

### GREENGUARD® CERTIFICATION

Company has achieved Greenguard certification on all products and Greenguard Gold on many. Please reference [saudereducation.com](http://saudereducation.com) for product specific information. GREENGUARD certified products are certified to meet GREENGUARD standards for low chemical emissions into indoor air during product usage. For more information, visit [https://spot.ulprospector.com/en/na/Built environment](https://spot.ulprospector.com/en/na/Built%20environment) or contact Company for a complete list of all our certified products.



Initials \_\_\_\_\_ Date \_\_\_\_\_

# TERMS AND CONDITIONS

## BIFMA

Sauder Manufacturing Co. is proud to demonstrate a commitment to the environment, and to both the quality and performance of products through BIFMA e3 LEVEL testing and certification. Learn more about BIFMA Certification at [levelcertified.org](http://levelcertified.org).



## SAFETY

Company does not warrant that row identification lighting for Auditorium Seating supplied by Company is suitable for illuminating stairs and/or trip hazards. Purchaser acknowledges that it will indemnify Company against any claims that may be made against it, arising out of Purchaser's reliance upon row identification lighting for illuminating stairs and/or trip hazards.

## FREIGHT & DELIVERY

### FREIGHT

Unless otherwise arranged in writing, all Company shipments are made on a site-to-site basis (back of trailer). Unless otherwise specified in writing, we will determine the method of shipment and carrier. All weights and dimensions provided in product literature are approximate. See map below for zone identification within the continental United States. Contact your authorized sales representative for pricing in Alaska, Hawaii and outside the United States.

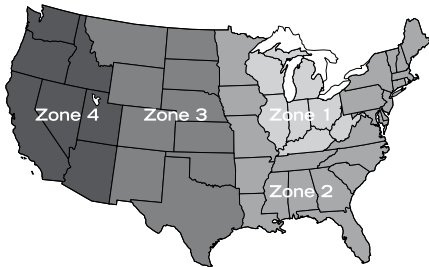

### MINIMUM SHIPPING AND HANDLING CHARGE

Orders that weigh less than 200 lb. will require an additional shipping and handling charge. See the chart to determine the net charge based on total order weight.

	0-10 lbs	11-20 lbs	21-50 lbs	51-100 lbs	101-199 lbs
<b>ZONE 1</b>	<b>\$50</b>	<b>\$70</b>	<b>\$80</b>	<b>\$100</b>	<b>\$130</b>
<b>ZONE 2</b>	<b>\$55</b>	<b>\$80</b>	<b>\$100</b>	<b>\$125</b>	<b>\$150</b>
<b>ZONE 3</b>	<b>\$60</b>	<b>\$90</b>	<b>\$120</b>	<b>\$150</b>	<b>\$175</b>
<b>ZONE 4</b>	<b>\$70</b>	<b>\$100</b>	<b>\$140</b>	<b>\$175</b>	<b>\$200</b>

Shipping and handling prices are net.

### BUILDING ACCESS

Facilities must be ready to receive furniture. All construction must be complete before we can start delivery and installation. There must be free and clear easy access to the building where the furniture will be installed. Rooms, hallways, lobby, and entrance way must be empty and free and clear of all obstructions. All buildings with 3 or more floors must have working elevators free and clear of all obstructions and dedicated for the sole use of our installers during our installation. If upon arrival for delivery and installation, the conditions described in this paragraph are not met, the installation will not be started, and additional charges may apply.

### DELAYED DELIVERY

Company reserves the right to increase prices or any part thereof, if Purchaser delays delivery of the furniture beyond 8 weeks from receipt of any of the following: Order Acknowledgment, signed order contract, receipt of subcontract, and/or receipt of signed purchase order. Purchaser agrees not to use the Goods described on the order until the full purchase price is paid to the Company.

In addition to any other right of Company to increase prices as set forth herein, in the event Purchaser, for any reason, directs delivery of goods and services ordered to occur beyond 8 weeks from receipt of any of the

following: Order Acknowledgment, signed order contract, receipt of subcontract, and/or receipt of signed purchase order, Purchaser shall bear the risk of and be responsible to pay Company any price increases that may occur in connection with the goods and services ordered as well as storage costs arising from or incurred as a result of same. Company reserves the right to require a non-refundable deposit be paid by Purchaser to Company in the event of the foregoing.

### DELIVERY

Company shall not be liable for delays in delivery of furniture caused by fire, strikes, weather or from causes beyond its control.

An on-site delivery date will be established once all details needed for production and installation (if applicable) have been received. Delivery of Goods may be separate from commencement of installation.

The delivery price submitted is based on the understanding that there shall be appropriate access to the site free of any hindrance whatsoever, timely access to the site and adequate space to unload the Goods. In the event that the site is not fully ready as described previously at the time of delivery, Company reserves the right to charge and collect additional fees to cover any additional costs incurred. These charges include but not limited to the following: delivery appointment, consolidation of shipment, lift gate, multiple stops, special packaging, dedicated truck, expedited shipment, greater than two hour unload time, box truck required, residential shipment.

The goods may arrive in cardboard boxes. Unless otherwise specified, it is the Purchaser's responsibility to arrange for the disposal of the boxes.

### SPECIAL DELIVERY CHARGES

Request to Carton	<b>\$20 per unit</b>
Delivery Appointment	<b>\$400</b>
Inside Delivery	<b>\$150 plus \$50/unit</b>
Lift Gate Required	<b>\$2500</b>
Multiple Stops	<b>\$250 per stop</b>
Box Truck Required*	<b>\$1200</b>

\*Required if 53' semi truck is too large to access dock.  
Above prices are net.

### STORAGE FEES

If Goods are ready for shipment according to the terms of the Order Acknowledgment or subsequent change order, and Customer cannot receive as stated, the Goods may, at our discretion, be shipped to storage facilities, or put in storage at Purchaser's expense. Company reserves the right to deny storage of the Goods due to lack of available space. Storage fees are 5% of purchase price per month. These charges can, at Company's option, be added to the order total amount due or invoiced separately. Storage fees are considered change orders. See CHANGE ORDER SECTION requirements. All storage fees are required to be paid in full before ship. All risk of damage, destruction, theft or loss while in storage shall be the responsibility of Purchaser.

### INSIDE DELIVERY

Purchaser accepts responsibility for the safety of all persons except Company representatives on the premises where Company performs delivery and/or inside delivery and, accordingly, Purchaser shall also defend and save Company harmless from all claims from persons injured on the premises where delivery and/or installation is performed.

The inside delivery contract price is based upon full building and location access and readiness for installation to begin upon on-site delivery. The space must be climate controlled, not affected by outside weather conditions, permanent utilities must be operational and carpet and/or any flooring must be complete. In addition, other contractors must not interfere with the unloading, staging or installation process including any overhead electrical, lighting or painting projects or any other work that would interfere with the

Initials \_\_\_\_\_ Date \_\_\_\_\_

# TERMS AND CONDITIONS

placement of the furniture into its permanent locations. Failure to have the site ready for installation may result in additional cost to the Purchaser not previously shown on the contract. These additional costs may include, but are not limited to, additional handling charges, insurance, down-time (which includes additional labor, lodging and meals), and/or any other proper expense incurred by the Company. If site conditions cause a substantial delay, the mover may leave the job site, delivery will be rescheduled and Purchaser will be responsible for the return fee for the delivery crew.

## RETURNS & CLAIMS

---

### RETURNS

No merchandise may be returned to Company without prior written consent from Company, and any returns must be in accordance with Company's shipping instructions. If approved, returns for reasons other than valid warranty claims will be subject to shipping and handling charges, and must be made, FOB the Company. In addition, restoration and restocking charges may be charged to Purchaser.

### DAMAGE CLAIMS

Freight terms are F.O.B. destination. Risk of loss, damage or destruction from and after delivery is the responsibility of Purchaser, it being agreed and understood that loss, damage or destruction of goods from and after delivery does not relieve Purchaser of its payment obligations to Company.

Purchaser is advised to inspect the shipment and note any damage on the bill of lading. Notification of damage discovered after delivery must be given to Company within 10 days immediately following delivery.

When products are shipped via Purchaser's choice of carrier, Company is not responsible for damage in shipment. Purchaser should carefully inspect all items at time of delivery and note any obvious damage on the delivery receipt. For Purchaser's protection, such obvious or subsequently discovered concealed damage must be reported in writing to the carrier in accordance with applicable regulations and time limits. Company does not assume any responsibility for damage that occurs during storage.

### OTHER CLAIMS

All claims against Company other than valid warranty claims, including claims for shortages and errors, must be made in writing within 10 days after delivery. The facts on which the claim is based must be directed in writing to the Warranty Service Coordinator. Failure to make any such claim against terms and conditions to Company within such 10-day period shall constitute acceptance of the merchandise and waiver of any such shortages, errors, or other claims of any type or nature. The cost of field repairs or adjustments performed by any non-Company personnel will not be reimbursed unless previously authorized in writing by Company.

## CONSEQUENTIAL LOSS

---

Under no circumstances shall Company be liable to any party hereto or any third-party for any special, indirect, punitive, incidental or consequential damages or loss (including lost profits, loss of use, damage to goodwill or loss of business) in connection with or in any way related to the agreement between the parties.

## FORCE MAJEURE AND OTHER MATTERS BEYOND COMPANY'S CONTROL

---

Company is not liable for failure to perform or delay in performance or delivery due to cancellation or postponement or deemed in breach of the Agreement (or PO if using Purchase Order) based on circumstances resulting from any cause beyond either parties control including, but not limited to, federal or state governmental orders or lack thereof, legislation, regulations, labor strikes, accidents, epidemic, pandemic, immediate threat of mass casualties or contagious illness or disease, act of war, riot, mass shooting, terrorism, acts of God, fires, severe weather conditions, floods, curtailment of transportation and or supply chain, inability to secure materials, electrical failure or any event that prohibits attendees being able to attend the event. Parties agree to minimize the damage of the Force Majeure Event to fullest extent possible. Notices shall state the nature of the Force Majeure Event, actions the party wishes to take, and if applicable a plan to mitigate any delays caused by the event. Such notice shall not subject either party to any penalties, liquidated damages, or forfeiture of any pre or post payment. Company reserves the right to modify order pricing and/or product offerings at any time based on material cost increases, supplier cost increases, economic fluctuations, supply chain issues and/or any other issues related to the foregoing. All orders may be subject to an increase in prices or any part thereof, and such other charges as set forth herein if Purchaser delays delivery of the furniture beyond 8 weeks from receipt of any of the following: Order Acknowledgment, signed order contract, receipt of subcontract, and/or receipt of signed purchase order.

Signature \_\_\_\_\_ Title \_\_\_\_\_ Date \_\_\_\_\_

## WARRANTY AND RENEWABILITY

All products are warranted to the original purchaser against factory defects in workmanship and materials which first arise and are reported to the company within the applicable warranty periods. This warranty information covers the structure of the furniture: the laminated-veneer or solid wood frame, the construction of the arms, table legs and stretchers, delamination of tables, and all fasteners and moving parts.

Years under Warranty – Structure							renewability	
Seating	1	2	3	5	10	25	full	component
Allure						X	X	
Bistro					X			
Bridge						X	X	
Canyon					X			
Cavetto						X	X	
Chancel						X		
Chandler					X			
Chill					X			X
Delta					X			X
Encore					X			X
Kirby						X		
Latitude						X	X	
Moment						X	X	
PlyFold					X			X
PlyLok						X		X
PlyWedge						X		X
Pose					X			X
Puzzle						X	X	
Rally						X	X	
Tanner					X			X
Trey®					X			X
Upland					X			X
Years under Warranty – Structure							renewability	
Tables	1	2	3	5	10	25	full	component
4700 Series						X		X
Ally						X		
Amigo						X		X
Cube						X		
Disc						X		X
Drum						X		
Dune					X			
Fuse						X		
Legacy					X			
Rowan					X			
Summit						X		X
Tanner					X			
Tapered Leg					X			
Trumpet						X		X
Tubular						X		X
Years under Warranty – Structure							renewability	

Student Room Furniture	1	2	3	5	10	25	full	component
Bed Accessories					X			
Bed Ends					X			
Endure						X		X
Mason					X			X
Mattresses				X				
Merit						X		X
Spring Bases				X				
zLok Components					X			
Accessories	1	2	3	5	10	25	full	component
Casters			X					
Fabric			X					
Foam			X					
Glides			X					
Power Unit	X							
Tablet Arms			X					

**Fabric:**

The Company warrants Sauder Program Fabrics, if purchased through Sauder for use on Sauder products for a period of 3 years.

Company has assembled an extensive graded-in offering featuring a wide selection of upholstery selected for performance. Sauder Program fabrics are available through Absecon, C.F. Stinson, Culp, Maharam, Mayer, and Momentum. Company warrants these textiles to perform under normal conditions as furniture upholstery and when cared for according to cleaning and maintenance guidelines provided by the textile supplier. Proper care and cleaning is imperative for maximizing textile performance. However, in the unlikely event that one of these upholstery does not perform in accordance with manufacturing specifications when used and maintained under normal conditions, and the user has not misused, cleaned or attempted to clean using cleaning agents or procedures not suggested or approved by the textile supplier, Company will replace the fabric free of charge.

**Exclusions:**

The following are specially excluded from the warranty:

1. Any custom components that are not a part of the company standard line. This would include, but not be limited to, custom-designed parts or customer specified components, such as fabric, vinyl, foam, etc., that are not a part of the standard company product line.
2. Accessories such as light bulbs that are considered consumables.
3. Furniture that has been unduly exposed to elements such as water, light radiation, etc.
4. Damage caused in storing/moving products or furniture after delivery and prior to installation – when stored at customer request.
5. Damage caused by on-site construction process, other contractors or subcontractors, or the work of such contractors or subcontractors, including drywall dust.
6. Damage as the result of accident, fire, flood, civil disorder, strike, Acts of God, abuse, misuse or any cause outside of ordinary usage.
7. Normal wear and tear, maintenance, scratching or natural wearing of finishes on chairs and tables.
8. Any responsibility for the effects the chairs have on flooring.

continued on next page

## WARRANTY AND RENEWABILITY

### 9. Fixed Seating:

- Not installed by Company or Company authorized personnel
- Loose floor anchors caused by flooring not being to standard
- Damage to on-site flooring, i.e. buckling, peeling, lifting, shifting or sliding due to substandard flooring installations
- If moved from original anchored locations, unless moved by authorized personnel
- Damage to the product as a result of inferior or damaged flooring surface

### 10. Damage caused from shipping.

### 11. Sourced 3rd party components for the Endure, Legacy and Merit product lines carry their manufacturer's warranty.

### General Information:

- A. We have agreements with our upholstery suppliers to assure that all products meet Association of Contract Textiles standards for bow and skew. We also further eliminate pattern variability in our cutting process. However, you may still notice some irregularities that are within industry standards and are not covered under our product warranty.
- B. Replacement, repair, or refund of the purchase price, (pro-rated for use), as determined by Company and is the "sole and exclusive" remedy under the warranty, and all incidental and consequential damages are excluded and disclaimed from warranty coverage.
- C. To receive benefits under the terms of this warranty, the purchaser must:
1. Notify Company of the defect.
  2. Fill out Company service request form, which will be sent to you, and provide a description of the defect.
  3. Submit completed form along with applicable photos.
- D. Any disputes over the provisions of this warranty will be mutually reviewed by representatives of Purchaser and Company.

**E. ALL IMPLIED WARRANTIES, INCLUDING ANY WARRANTIES OF MERCHANTABILITY OR FITNESS FOR A PARTICULAR PURPOSE ARE EXCLUDED AND DISCLAIMED. THIS LIMITED WARRANTY IS THE ONLY WARRANTY FROM COMPANY APPLICABLE TO THE GOODS.**

### TYPES OF RENEWABILITY

---

**Fully Renewable:** These products have replaceable covers with hook and loop upholstery attachment and most components are replaceable as well.

**Component Replaceable:** Entire seat cushions (wood/foam/upholstery) and back cushions (wood/foam/upholstery) are replaceable. Additional replaceable components may vary per product. Additional component examples: Arms, tops, foot or casters, arm or back caps, handles, drawers or doors, etc.

See Chart for product details.

# QUICK SHIP PROGRAM, FABRIC INFORMATION & ADDITIONAL OPTIONS

## QUICK SHIP PROGRAM

---

### INFORMATION AND PRODUCT AVAILABILITY

Choose from the following models, standard finishes and selected fabrics:

#### AVAILABLE MODELS

- PlyFold
- PlyLok
- PlyWedge
- Trey®

#### QUICK SHIP TERMS AND CONDITIONS

1. A written, faxed or e-mailed purchase order must be received by Company before the order will be released for production.
2. Cancellations and change orders cannot be permitted after receipt of written, faxed or e-mailed purchase order.
3. All Program orders will ship within 20 WORKING DAYS after receipt of order (ARO) with complete details, including finish and fabric selection.  
  
Lead times on the Program may be extended at peak production times during the year, due to production schedules being at maximum capacity.
4. If Company program upholstery is back-ordered or COM upholstery is specified, your order will be produced 20 WORKING DAYS after receipt of upholstery requirements.
5. Maximum quantity for the Program is 25 chairs. Larger quantities require the standard lead-time.

## FABRIC INFORMATION

---

### FABRIC ZONES

Fabric zoning (using different fabrics for seat, back, etc.) is available without an additional charge. When multiple fabric grades are selected, unit price is based on the highest fabric grade selected. Zoning worksheets must be submitted for lounge products.

### FABRIC GRADES

Fabric pricing for patterns greater than L are available from your representative by quote.

## ADDITIONAL OPTIONS

---

### FINISH MATCH

Specify at time of quoting.

Custom Finish Match ..... 1041 per order

*Only on select products, contact your rep for additional information.*

# SEATING

## ALLURE

Product No	Description	COM Ydg	Moist. Barrier	Zone 1	Zone 2	Zone 3	Zone 4
58111	CHAIR	5.75 yd	Included	3652	3743	3835	3926
58112	LOVESEAT	7 yd	Included	6170	6324	6478	6633
58113	SOFA	9.25 yd	Included	7454	7640	7827	8013

## BISTRO

Product No	Description	COM Ydg	Moist. Barrier	Zone 1	Zone 2	Zone 3	Zone 4
7924350	BISTRO SIDE CHAIR, METAL FRAME, UPH SEAT	.75 yd	-	747	766	784	803
7924360	BISTRO SIDE CHAIR, METAL FRAME, WOOD SEAT	-	-	653	669	686	702
7924351	BISTRO COUNTER STOOL, METAL FRAME, UPH SEAT	.75 yd	-	839	860	881	902
7924361	BISTRO COUNTER STOOL, METAL FRAME, WOOD SEAT	-	-	735	753	772	790
7924352	BISTRO BAR STOOL, METAL FRAME, UPH SEAT	.75 yd	-	948	972	995	1019
7924362	BISTRO BAR STOOL, METAL FRAME, WOOD SEAT	-	-	811	831	852	872

## BRIDGE

Product No	Description	COM Ydg	Moist. Barrier	Zone 1	Zone 2	Zone 3	Zone 4
C30-1	AUBURN CHAIR	5.25 yd	Included	3319	3402	3485	3568
C30-2	AUBURN LOVESEAT	6.5 yd	Included	5621	5762	5902	6043
C30-3	AUBURN SOFA	10.25 yd	Included	6755	6924	7093	7262
C30-OT	AUBURN OTTOMAN	3.25 yd	Included	1210	1240	1270	1301
C01-1	GARRETT CHAIR	6.5 yd	Included	3223	3304	3384	3465
C01-2	GARRETT LOVESEAT	8 yd	Included	5432	5568	5704	5839
C01-3	GARRETT SOFA	9.75 yd	Included	6539	6702	6866	7029
C01-OT	GARRETT OTTOMAN	3.25 yd	Included	1202	1232	1262	1292

## CANYON

Product No	Description	COM Ydg	Moist. Barrier	Zone 1	Zone 2	Zone 3	Zone 4
7977260	CHAIR	5.75 yd	69	2342	2401	2459	2518
7977261	LOVESEAT	8.5 yd	102	3702	3795	3887	3980
7977262	SOFA	11 yd	132	4836	4957	5078	5199

## CAVETTO

Product No	Description	COM Ydg	Moist. Barrier	Zone 1	Zone 2	Zone 3	Zone 4
59111	CHAIR	5.25 yd	Included	4126	4229	4332	4435
59112	LOVESEAT	8 yd	Included	6999	7174	7349	7524
59113	SOFA	10.5 yd	Included	8460	8672	8883	9094

## CAVETTO OPTIONS

Product No	Description	Zones 1-4
-	CAVETTO METAL LEG UPCHARGE	155
-	CAVETTO MOBILITY W/ WOOD LEGS	336
-	CAVETTO MOBILITY W/ METAL LEGS	406
-	CAVETTO TABLET ARMS, TL AND TR	958

Premium Fabric Grades	B	C	D	E	F	G	H	I	J	K	L
Multiply by COM Ydg	16	36	55	79	119	158	198	237	277	356	435

Available for an upcharge. List price per yard.

*eQuote is available for live configuration pricing. Contact customer service or sales representative with questions.*

# SEATING

## CHANDLER

Product No	Description	COM Ydg	Moist. Barrier	Zone 1	Zone 2	Zone 3	Zone 4
7924345	CHANDLER SIDE CHAIR, UPH SEAT	.75 yd	-	591	606	621	635
7924355	CHANDLER SIDE CHAIR, ALL WOOD	-	-	565	579	593	607

## CHILL

Product No	Description	COM Ydg	Moist. Barrier	Zone 1	Zone 2	Zone 3	Zone 4
15111	CHAIR WITH 1 UPH ARM	4.25 yd	-	2533	2596	2660	2723
15311	CHAIR	4.75 yd	-	2725	2793	2861	2929
15312	LOVESEAT	6.25 yd	-	4135	4238	4342	4445
15313	SOFA	8.25 yd	-	5308	5441	5573	5706
15401	ARMLESS CHAIR	3.25 yd	-	2365	2424	2483	2542
15441	CORNER CHAIR	4.75 yd	-	3120	3198	3276	3354
15-OT	OTTOMAN, SQUARE	3.25 yd	-	2484	2546	2608	2670
15-OT-M	OTTOMAN, INLINE	2.75 yd	-	1958	2007	2056	2105

## CHILL OPTIONS

Product No	Description	Zones 1-4
-	TUBULAR LEG	228
-	SLEDBASE LEG	228
-	THERMOFORM TABLE TOP FOR 15-OT	781
-	LAMINATE TABLE TOP FOR 15-OT	919
-	THERMOFORM TABLE TOP FOR 15-OT-M	434
-	LAMINATE TABLE TOP FOR 15-OT-M	644
-	GANGING OPTION 1 ARM CHAIR ON ARMLESS SIDE ONLY	125
-	GANGING - ARMLESS, CORNER, INLINE OTTOMAN AND 1-ARM CHAIR ON BOTH SIDES	184
-	GANGING - SQUARE OTTOMAN	308
-	CHILL POWER	573

## DELTA

Product No	Description	COM Ydg	Moist. Barrier	Zone 1	Zone 2	Zone 3	Zone 4
82DT35UP	CHAIR, UPH SEAT, UPH BACK, CASTERS, 18"	.7 yd	-	1033	1059	1085	1110
83DT15UP	CHAIR, UPH SEAT, UPH BACK, CASTERS, 22"	.7 yd	-	1109	1137	1164	1192
82DT35US	CHAIR, UPH SEAT, PLASTIC BACK, CASTERS, 18"	.35 yd	-	982	1007	1031	1056
83DT15US	CHAIR, UPH SEAT, PLASTIC BACK, CASTERS, 22"	.35 yd	-	1055	1081	1108	1134
82DT35	CHAIR, PLASTIC SEAT, PLASTIC BACK, CASTERS, 18"	-	-	820	840	861	882
83DT15	CHAIR, PLASTIC SEAT, PLASTIC BACK, CASTERS, 22"	-	-	877	899	921	943
82DT34UP	CHAIR, UPH SEAT UPH BACK, GLIDES, 18"	.7 yd	-	1033	1059	1085	1110
83DT14UP	CHAIR, UPH SEAT, UPH BACK, GLIDES, 22"	.7 yd	-	1109	1137	1164	1192
82DT34US	CHAIR, UPH SEAT, PLASTIC BACK, GLIDES, 18"	.35 yd	-	982	1007	1031	1056
83DT14US	CHAIR, UPH SEAT, PLASTIC BACK, GLIDES, 22"	.35 yd	-	1055	1081	1108	1134
82DT34	CHAIR, PLASTIC SEAT, PLASTIC BACK, GLIDES, 18"	-	-	820	840	861	882
83DT14	CHAIR, PLASTIC SEAT, PLASTIC BACK, GLIDES, 22"	-	-	877	899	921	943
82DT25UP	ARM CHAIR, UPH SEAT, UPH BACK, CASTERS, 18"	.7 yd	-	1109	1137	1164	1192

Premium Fabric Grades	B	C	D	E	F	G	H	I	J	K	L
Multiply by COM Ydg	16	36	55	79	119	158	198	237	277	356	435

Available for an upcharge. List price per yard.

*eQuote is available for live configuration pricing. Contact customer service or sales representative with questions.*

# SEATING

## DELTA

Product No	Description	COM Ydg	Moist. Barrier	Zone 1	Zone 2	Zone 3	Zone 4
83DT05UP	ARM CHAIR, UPH SEAT, UPH BACK, CASTERS, 22"	.7 yd	-	1191	1221	1251	1280
82DT25US	ARM CHAIR, UPH SEAT, PLASTIC BACK, CASTERS, 18"	.35 yd	-	1057	1083	1110	1136
83DT05US	ARM CHAIR, UPH SEAT, PLASTIC BACK, CASTERS, 22"	.35 yd	-	1134	1162	1191	1219
82DT25	ARM CHAIR, PLASTIC SEAT, PLASTIC BACK, CASTERS, 18"	-	-	897	919	942	964
83DT05	ARM CHAIR, PLASTIC SEAT PLASTIC BACK, CASTERS, 22"	-	-	957	981	1005	1029
82DT24UP	ARM CHIAR, UPHSEAT, UPH BACK, GLIDES, 18"	.7 yd	-	1109	1137	1164	1192
83DT04UP	ARM CHAIR, UPH SEAT UPH BACK, GLIDES, 22"	.7 yd	-	1191	1221	1251	1280
82DT24US	ARM CHAIR, UPH SEAT, PLASTIC BACK, GLIDES, 18"	.35 yd	-	1057	1083	1110	1136
83DT04US	ARM CHAIR, UPH SEAT PLASTIC BACK, GLIDES, 22"	.35 yd	-	1134	1162	1191	1219
82DT24	ARM CHAIR, PLASTIC SEAT, PLASTIC BACK, GLIDES, 18"	-	-	897	919	942	964
83DT04	ARM CHAIR, PLASTIC SEAT, PLASTIC BACK, ARMS, GLIDES, 22"	-	-	957	981	1005	1029

## DELTA OPTIONS

Product No	Description	Zones 1-4
-	SOFT CASTERS ( FOR HARD SURFACE)	35
-	EXTRA SEAT FOAM FOR 18" CHAIRS	24
-	EXTRA SEAT FOAM FOR 22" CHAIRS	37

## ENCORE

Product No	Description	COM Ydg	Moist. Barrier	Zone 1	Zone 2	Zone 3	Zone 4
7020652	SIDE CHAIR	1.2 yd	14	761	780	799	818
7020662	SIDE CHAIR, NON-UPH	-	-	651	667	684	700
7320652	ARM CHAIR	1.2 yd	14	935	958	982	1005
7320662	ARM CHAIR, NON-UPH	-	-	812	832	853	873

## KIRBY

Product No	Description	COM Ydg	Moist. Barrier	Zone 1	Zone 2	Zone 3	Zone 4
81KR01	COLLABORATIVE STOOL 16"DIA	1.3 yd	-	815	835	856	876
81KR02	COLLABORATIVE STOOL 18"SQ	1.9 yd	-	953	977	1001	1024
81KR03	COLLABORATIVE STOOL 16" CRESCENT	1.3 yd	-	935	958	982	1005

## LATITUDE

Product No	Description	COM Ydg	Moist. Barrier	Zone 1	Zone 2	Zone 3	Zone 4
10311	CHAIR	2.75 yd	Included	3422	3508	3593	3679
10312	LOVESEAT	4 yd	Included	4948	5072	5195	5319
10313	SOFA	5.25 yd	Included	6007	6157	6307	6458
10312CT	2 SEAT, CENTER TABLE	5 yd	Included	6003	6153	6303	6453
10312WT	LOVESEAT, WING TABLES	4 yd	Included	5720	5863	6006	6149
10392	2 SEAT BENCH	1.75 yd	Included	4195	4300	4405	4510
10393	3 SEAT BENCH	2.75 yd	Included	5071	5198	5325	5451
10392CT	2 SEAT BENCH, CENTER TABLE	1.75 yd	Included	5083	5210	5337	5464

Premium Fabric Grades	B	C	D	E	F	G	H	I	J	K	L
Multiply by COM Ydg	16	36	55	79	119	158	198	237	277	356	435

Available for an upcharge. List price per yard.

*eQuote is available for live configuration pricing. Contact customer service or sales representative with questions.*

# SEATING

## LATITUDE OPTIONS

Product No	Description	Zones 1-4
-	LATITUDE POWER	547
-	LATITUDE WOOD ARM CAP (2 ARMS)	305
-	LATITUDE WOOD ARM CAP ( 3 ARMS)	458
-	LATITUDE WOOD ARM CAP (4 ARMS)	610
-	LATITUDE SOLID SURFACE ARM CAP (2 ARMS)	460
-	LATITUDE SOLID SURFACE ARM CAP ( 3 ARMS)	690
-	LATITUDE SOLID SURFACE ARM CAP (4 ARMS)	920
-	LATITUDE CENTER TABLE SOLID SURFACE	538
-	LATITUDE WING TABLE SOLID SURFACE	616

## MOMENT

Product No	Description	COM Ydg	Moist. Barrier	Zone 1	Zone 2	Zone 3	Zone 4
57111	CHAIR	6.25 yd	Included	3612	3702	3793	3883
57112	LOVESEAT	9 yd	Included	6112	6265	6418	6570
57113	SOFA	13.5 yd	Included	7489	7676	7863	8051

## PLYFOLD

Product No	Description	COM Ydg	Moist. Barrier	Zone 1	Zone 2	Zone 3	Zone 4
7028201	FOLDING CHAIR, UPH SEAT AND BACK, WOOD BACKSIDE, STACKING	.5 yd	6	821	842	862	883
7028202	FOLDING CHAIR, UPH SEAT AND BACK, WOOD BACKSIDE, 2" WIDER, STACKING	.5 yd	6	846	867	888	909
7028204	FOLDING CHAIR, UPH SEAT, WOOD BACK, STACKING	.4 yd	5	897	919	942	964
7023201	FOLDING CHAIR, WOOD SEAT, WOOD BACK, STACKING	-	-	971	995	1020	1044

## PLYFOLD OPTIONS

Product No	Description	Zones 1-4
7100001	LASER CUT (320 SETUP CHARGE PER ORDER)	210
7100002	LASER CUT WITH COLOR (320 SETUP CHARGE PER ORDER)	309
-	CUSTOM HEIGHT (MAXIMUM CUT-OFF IS 2")	40
7070004	HANGING WALL BRACKET	38
7190004	UNDERSEAT PANEL, PLYFOLD STANDARD WIDTH	99
7190012	UNDERSEAT PANEL, PLYFOLD WIDER WIDTH	105
7074129	INTERLOCK, METAL, STRAIGHT	8
7144000	PLASTITACK GLIDES, SET OF FOUR	11
7144012	CHROME RUBBER CUSHIONED GLIDES, SET OF FOUR	11
7144013	NON-SKID RUBBER CUSHIONED PLASTITACK GLIDES, SET OF FOUR	11
7144022	ACCESSORIES PLASTIC CAPS FOR 4012 GLIDE	11
7034126	DOLLY FOR FOLDING CHAIRS	1543
7034127	DOLLY FOR FOLDING CHAIRS, 2" WIDER	1570
7032000	UNIVERSAL 2-WHEEL CART	1188
7034003	DOLLY EXTENSIONS FOR PLYFOLD	315

Premium Fabric Grades	B	C	D	E	F	G	H	I	J	K	L
Multiply by COM Ydg	16	36	55	79	119	158	198	237	277	356	435

Available for an upcharge. List price per yard.

*eQuote is available for live configuration pricing. Contact customer service or sales representative with questions.*

# SEATING

## PLYLOK

Product No	Description	COM Ydg	Moist. Barrier	Zone 1	Zone 2	Zone 3	Zone 4
7028862	2-POSITION CHAIR, UPH SEAT, NON-STACKING	.8 yd	10	681	698	715	732
7028849	2 POSITION CHAIR, UPH SEAT, 2" WIDER, NON-STACKING	.9 yd	11	777	796	816	835
7023810	2-POSITION CHAIR, WOOD SEAT, NON-STACKING	.5 yd	-	681	698	715	732
7028843	SLEDBASE CHAIR, UPH SEAT, NON-STACKING	.8 yd	10	758	777	796	815
7023715	SLEDBASE CHAIR, WOOD SEAT, NON-STACKING	.5 yd	-	758	777	796	815
7028962	3-POSITION CHAIR, UPH SEAT, NON-STACKING	.8 yd	10	719	737	755	773
7028944	3-POSITION CHAIR, UPH SEAT, 2" NARROWER, NON-STACKING	.8 yd	10	719	737	755	773
7028949	3-POSITION CHAIR, UPH SEAT, 2" WIDER, NON-STACKING	.9 yd	11	777	796	816	835
7023910	3-POSITION CHAIR, WOOD SEAT, NON-STACKING	.5 yd	-	714	732	750	768
7028742	SIDE CHAIR, UPH SEAT, STACKING	.8 yd	10	636	652	668	684
7028744	SIDE CHAIR, UPH SEAT, 2" NARROWER, STACKING	.8 yd	10	636	652	668	684
7028749	SIDE CHAIR, UPH SEAT, 2" WIDER, STACKING	.9 yd	11	690	707	724	742
7023711	SIDE CHAIR, WOOD SEAT, STACKING	.5 yd	-	634	650	666	682
7023712	SIDE CHAIR, WOOD SEAT, 2" NARROWER, STACKING	.5 yd	-	634	650	666	682
7328748	ARM CHAIR, UPH SEAT, STACKING	.8 yd	10	857	878	900	921
7323718	ARM CHAIR, WOOD SEAT, STACKING	.5 yd	-	855	876	898	919
7323719	ARM CHAIR, WOOD SEAT, 2" WIDER, STACKING	.5 yd	-	891	913	936	958
7128744	BAR STOOL, UPH SEAT	.8 yd	10	1189	1219	1248	1278
7123712	BAR STOOL, WOOD SEAT	.5 yd	-	1184	1214	1243	1273
7228744	COUNTER STOOL, UPH SEAT	.8 yd	10	1181	1211	1240	1270
7223712	COUNTER STOOL, WOOD SEAT	.5 yd	-	1178	1207	1237	1266

## PLYLOK OPTIONS

Product No	Description	Zones 1-4			
7100001	LASER CUT (320 SETUP CHARGE PER ORDER)	210			
7100002	LASER CUT WITH COLOR (320 SETUP CHARGE PER ORDER)	309			
-	EXTENDED PAD	67			
-	PLYLOK 2" SEAT FOAM	29			
-	CUSTOM HEIGHT (MAXIMUM CUT-OFF IS 2", 4-LEG CHAIRS ONLY)	40			
7190005	UNDERSEAT WOOD PANEL, PLYLOK MODELS	99			
7190006	UNDERSEAT WOOD PANEL, PLYLOK 2" NARROWER MODELS	99			
7144014	T MOLD RUNNER (SET OF TWO)	43			
7070011	2" HIGH PLASTIC LEG PROTECTORS (SET OF FOUR)	80			
7070018	LEG PROTECTOR, CLEAR, (SET OF TWO)	40			
7144000	PLASTITACK GLIDES, SET OF FOUR	11			
7144012	CHROME RUBBER CUSHIONED GLIDES, SET OF FOUR	11			
7144013	NON-SKID RUBBER CUSHIONED PLASTITACK GLIDES, SET OF FOUR	11			
7144022	ACCESSORIES PLASTIC CAPS FOR 4012 GLIDE	11			
7074129	INTERLOCK, METAL, STRAIGHT	8			
7074130	INTERLOCK, METAL, RADIUS	47			
7032000	UNIVERSAL 2-WHEEL CART	1188	1218	1247	1277

Premium Fabric Grades	B	C	D	E	F	G	H	I	J	K	L
Multiply by COM Ydg	16	36	55	79	119	158	198	237	277	356	435

Available for an upcharge. List price per yard.

*eQuote is available for live configuration pricing. Contact customer service or sales representative with questions.*

# SEATING

## PLYWEDGE

Product No	Description	COM Ydg	Moist. Barrier	Zone 1	Zone 2	Zone 3	Zone 4
7028860	2 POSITION CHAIR, UPH SEAT, ALL UPH BACK, NON-STACKING	1 yd	12	604	619	634	649
7028861	2 POSITION CHAIR, UPH SEAT, WOOD BACK, NON-STACKING	.5 yd	6	604	619	634	649
7023860	2 POSITION CHAIR, WOOD SEAT, WOOD BACK, NON-STACKING	-	-	604	619	634	649
7028760	SIDE CHAIR, UPH SEAT, ALL UPH BACK, NON-STACKING	1 yd	12	560	574	588	602
7028761	SIDE CHAIR, UPH SEAT, WOOD BACK, NON-STACKING	.5 yd	6	560	574	588	602
7023760	SIDE CHAIR, WOOD SEAT, WOOD BACK, NON-STACKING	-	-	560	574	588	602
7028960	3 POSITION CHAIR, UPH SEAT, ALL UPH BACK, NON-STACKING	1 yd	12	647	663	679	696
7028961	3 POSITION CHAIR, UPH SEAT, WOOD BACK, NON-STACKING	.5 yd	6	647	663	679	696
7023960	3 POSITION CHAIR, WOOD SEAT, WOOD BACK, NON-STACKING	-	-	647	663	679	696

## PLYWEDGE OPTIONS

Product No	Description	Zones 1-4
7100001	LASER CUT (320 SETUP CHARGE PER ORDER)	210
7100002	LASER CUT WITH COLOR (320 SETUP CHARGE PER ORDER)	309
7070010	WELT CORD	43
-	CUSTOM HEIGHT (MAXIMUM CUT-OFF IS 2", 4-LEG CHAIRS ONLY)	40
7144014	T MOLD RUNNER (SET OF TWO)	43
7070011	2" HIGH PLASTIC LEG PROTECTORS (SET OF FOUR)	80
7070018	LEG PROTECTOR, CLEAR, (SET OF TWO)	40
7144000	PLASTITACK GLIDES, SET OF FOUR	11
7144012	CHROME RUBBER CUSHIONED GLIDES, SET OF FOUR	11
7144013	NON-SKID RUBBER CUSHIONED PLASTITACK GLIDES, SET OF FOUR	11
7144022	ACCESSORIES PLASTIC CAPS FOR 4012 GLIDE	11
7074129	INTERLOCK, METAL, STRAIGHT	8
7074130	INTERLOCK, METAL, RADIUS	47

## POSE

Product No	Description	COM Ydg	Moist. Barrier	Zone 1	Zone 2	Zone 3	Zone 4
243144	COUNTER STOOL, 24"H SEAT	.25 yd	-	773	792	812	831
243147	BAR STOOL, 30"H SEAT	.25 yd	-	791	811	831	850

## PUZZLE

Product No	Description	COM Ydg	Moist. Barrier	Zone 1	Zone 2	Zone 3	Zone 4
61411	ARMLESS CHAIR	4 yd	Included	3056	3132	3209	3285
61111	CHAIR WITH UPH ARM	4 yd	Included	3816	3911	4007	4102
61121	CHAIR WITH 2 UPH ARMS	5.5 yd	Included	4577	4691	4806	4920
61211	CHAIR WITH TABLE ARM	4.25 yd	Included	4642	4758	4874	4990
61311	CHAIR WITH TABLE AND UPH ARM	5.25 yd	Included	5171	5300	5430	5559
61-OT	OTTOMAN	3.25 yd	Included	1963	2012	2061	2110

Premium Fabric Grades	B	C	D	E	F	G	H	I	J	K	L
Multiply by COM Ydg	16	36	55	79	119	158	198	237	277	356	435

Available for an upcharge. List price per yard.

*eQuote is available for live configuration pricing. Contact customer service or sales representative with questions.*

# SEATING

## PUZZLE OPTIONS

Product No	Description	Zones 1-4
-	PUZZLE THERMOFORM TABLE TOP SURFACE FOR OTTOMAN	813
-	PUZZLE GANGING ONE ARM	75
-	PUZZLE GANGING NO ARMS	114
-	PUZZLE POWER (OUTLET)	701
-	PUZZLE POWER (OUTLET) FOR BOTH ARMS	1402
-	PUZZLE POWER (USB)	829
-	PUZZLE POWER (USB) FOR BOTH ARMS	1658

## RALLY

Product No	Description	COM Ydg	Moist. Barrier	Zone 1	Zone 2	Zone 3	Zone 4
64331	ASPIRE CHAIR	6.25 yd	Included	3486	3573	3660	3747
64131	ASPIRE CHAIR WITH 1 UPH ARM	5 yd	Included	3230	3311	3392	3472
64332	ASPIRE LOVESEAT	8.5 yd	Included	5429	5565	5700	5836
64132	ASPIRE LOVESEAT WITH 1 UPH ARM	7.25 yd	Included	5180	5310	5439	5568
64333	ASPIRE SOFA	10.75 yd	Included	7007	7182	7357	7533
64133	ASPIRE SOFA WITH 1 UPH ARM	9.5 yd	Included	6756	6925	7094	7263
64311	EMBRACE CHAIR	6.25 yd	Included	3462	3549	3635	3722
64111	EMBRACE CHAIR WITH 1 UPH ARM	4.75 yd	Included	3205	3285	3365	3445
64312	EMBRACE LOVESEAT	8.5 yd	Included	5392	5527	5662	5796
64112	EMBRACE LOVESEAT WITH 1 UPH ARM	7 yd	Included	5139	5267	5396	5524
64313	EMBRACE SOFA	10.75 yd	Included	6956	7130	7304	7478
64113	EMBRACE SOFA WITH 1 UPH ARM	9.25 yd	Included	6701	6869	7036	7204
64321	INDULGE CHAIR	5.5 yd	Included	3462	3549	3635	3722
64121	INDULGE CHAIR WITH 1 UPH ARM	4.5 yd	Included	3205	3285	3365	3445
64322	INDULGE LOVESEAT	8 yd	Included	5392	5527	5662	5796
64122	INDULGE LOVESEAT WITH 1 UPH ARM	7 yd	Included	5139	5267	5396	5524
64323	INDULGE SOFA	10.25 yd	Included	6956	7130	7304	7478
64123	INDULGE SOFA WITH 1 UPH ARM	9.25 yd	Included	6701	6869	7036	7204
64371	RISE CHAIR	6 yd	Included	3462	3549	3635	3722
64171	RISE CHAIR WITH 1 UPH ARM	4.5 yd	Included	3205	3285	3365	3445
64372	RISE LOVESEAT	8.25 yd	Included	5392	5527	5662	5796
64172	RISE LOVESEAT WITH 1 UPH ARM	6.75 yd	Included	5139	5267	5396	5524
64373	RISE SOFA	10.5 yd	Included	6956	7130	7304	7478
64173	RISE SOFA WITH 1 UPH ARM	9.25 yd	Included	6701	6869	7036	7204
64361	UNWIND CHAIR	5.75 yd	Included	3486	3573	3660	3747
64161	UNWIND CHAIR WITH 1 UPH ARM	4.5 yd	Included	3230	3311	3392	3472
64362	UNWIND LOVESEAT	8 yd	Included	5429	5565	5700	5836
64162	UNWIND LOVESEAT WITH 1 UPH ARM	6.75 yd	Included	5180	5310	5439	5568
64163	UNWIND SOFA WITH 1 UPH ARM	9.25 yd	Included	6756	6925	7094	7263
64363	UNWIND SOFA	10.5 yd	Included	7007	7182	7357	7533
64341	COMPOSE CHAIR	6.25 yd	Included	6536	6699	6863	7026
64141	COMPOSE CHAIR WITH 1 TABLE ARM	4.75 yd	Included	4458	4569	4681	4792

Premium Fabric Grades	B	C	D	E	F	G	H	I	J	K	L
Multiply by COM Ydg	16	36	55	79	119	158	198	237	277	356	435

Available for an upcharge. List price per yard.

*eQuote is available for live configuration pricing. Contact customer service or sales representative with questions.*

# SEATING

RALLY							
Product No	Description	COM Ydg	Moist. Barrier	Zone 1	Zone 2	Zone 3	Zone 4
64342	COMPOSE LOVESEAT	8.5 yd	Included	7694	7886	8079	8271
64142	COMPOSE LOVESEAT WITH 1 TABLE ARM	7 yd	Included	5657	5798	5940	6081
64343	COMPOSE SOFA	11 yd	Included	8743	8962	9180	9399
64143	COMPOSE SOFA WITH 1 TABLE ARM	9.5 yd	Included	6708	6876	7043	7211
64241	COMPOSE CHAIR WITH TABLE ARM AND EMBRACE ARM	6.25 yd	Included	5281	5413	5545	5677
64242	COMPOSE LOVESEAT WITH TABLE ARM AND EMBRACE ARM	8.5 yd	Included	6462	6624	6785	6947
64243	COMPOSE SOFA WITH TABLE ARM AND EMBRACE ARM	10.75 yd	Included	7512	7700	7888	8075
64401	ARMLESS CHAIR	3.5 yd	Included	2383	2443	2502	2562
64402	ARMLESS LOVESEAT	5.75 yd	Included	3714	3807	3900	3993
64403	ARMLESS SOFA	8 yd	Included	4787	4907	5026	5146
64441	CORNER CHAIR	4.75 yd	Included	3608	3698	3788	3879
64454	INSIDE WEDGE CHAIR, 30-DEGREE ANGLE WITH WIDE BACK	4.25 yd	Included	2976	3050	3125	3199
64455	OUTSIDE WEDGE CHAIR, 30-DEGREE ANGLE WITH NARROW BACK	3.75 yd	Included	2721	2789	2857	2925
64-WG-OT	WEDGE OTTOMAN, 30-DEGREE ANGLE	3 yd	Included	1784	1829	1873	1918
64550	WEDGE TABLE, 30-DEGREE ANGLE	2.75 yd	Included	2466	2528	2589	2651
64500	INTEGRATED TABLE	1.75 yd	Included	3343	3427	3510	3594
64-OT	OTTOMAN	3 yd	Included	1674	1716	1758	1800
64-CT-OT	COFFEE TABLE OTTOMAN	2 yd	Included	4151	4255	4359	4462
6422-OT	22" ROUND OTTOMAN	1.5 yd	Included	2163	2217	2271	2325
6430-OT	30" ROUND OTTOMAN	2.75 yd	Included	2521	2584	2647	2710
6436-OT	36" ROUND OTTOMAN	3 yd	Included	2884	2956	3028	3100
6422-ET-OT	22" ROUND END TABLE	1.5 yd	Included	2477	2539	2601	2663

## RALLY OPTIONS

Product No	Description	Zones 1-4
7070021	GANGING KIT, 1 ARM CHAIR	75
7070022	GANGING KIT, ARMLESS	114
7070023	GANGING KIT, OTTOMAN	200
7070030	GANGING KIT, EMBRACE 1 ARM	75
7070031	GANGING KIT, EMBRACE 2 ARM	114
-	RALLY MOBILITY CASTERS FOR 64341	627
-	RALLY MOBILITY CASTERS FOR 64141 AND 64241	473
-	RALLY MOBILITY CASTERS FOR ALL OTHER MODELS	305
-	RALLY SLED BASE OPTION FOR 64341	197
-	RALLY SLED BASE OPTION FOR 64453	390
-	RALLY SLED BASE OPTION FOR ALL OTHER MODELS	132
-	RALLY BACK CAP	114
-	RALLY BACK CAP CORNER OPTION	302
-	RALLY MID-BACK CORNER OPTION	336
-	RALLY MID-BACK LOVESEAT	336
-	RALLY MID-BACK SOFA	498
-	RALLY MID-BACK OPTION	166

Premium Fabric Grades	B	C	D	E	F	G	H	I	J	K	L
<b>Multiply by COM Ydg</b>	16	36	55	79	119	158	198	237	277	356	435

Available for an upcharge. List price per yard.

eQuote is available for live configuration pricing. Contact customer service or sales representative with questions.

# SEATING

## RALLY OPTIONS

Product No	Description	Zones 1-4
-	RALLY POWER (OUTLET)	701
-	RALLY POWER (OUTLET) FOR BOTH ARMS	1402
-	RALLY POWER (USB)	829
-	RALLY POWER (USB) FOR BOTH ARMS	1658
-	RALLY EMBRACE ARM CAP	169
-	RALLY STANDARD TABLE TOP SURFACE FOR OTTOMAN	1585
-	RALLY LOW TABLE TOP SURFACE FOR OTTOMAN	566
-	SLED FOOT FOR ROUND OTTOMANS	201
-	CASTERS FOR ROUND OTTOMANS	384
-	22" TABLE TOP FOR ROUND OTTOMANS	252
-	30" TABLE TOP FOR ROUND OTTOMANS	419
-	36" TABLE TOP FOR ROUND OTTOMANS	668
-	RALLY WEDGE OTTOMAN LOW TABLE TOP	495
-	RALLY WEDGE MID-BACK OPTION - INSIDE	239
-	RALLY WEDGE MID-BACK OPTION - OUTSIDE	129
-	RALLY WEDGE BACK CAP OPTION	114
-	RALLY STANDARD TABLE TOP OTTOMAN LAMINATE	1563
-	RALLY 64-OT LOW OTTOMAN LAMINATE	757
-	RALLY 64500 INTEGRATED TABLE LAMINATE TOP	192
-	RALLY/COMPOSE LAMINATE ARM TOP (1 ARM)	294
-	RALLY/COMPOSE LAMINATE ARM TOP (2 ARM)	588
-	RALLY 64-CT-OT LAMINATE TOP	284
-	6422-OT 22" LAMINATE TABLE TOP	383
-	6430-OT 30" LAMINATE TABLE TOP	614
-	6436-OT 36" LAMINATE TABLE TOP	914
-	RALLY 64-WG-OT/64550 WEDGE OTTOMAN LAMINATE TOP	730
-	RALLY 6422-ET-OT END TABLE LAMINATE TOP	140

## TREY

Product No	Description	COM Ydg	Moist. Barrier	Zone 1	Zone 2	Zone 3	Zone 4
7020650	SIDE CHAIR	1.2 yd	14	974	998	1023	1047
7320650	ARM CHAIR	1.2 yd	14	1131	1159	1188	1216
7200650	FLOOR ROCKER	1.2 yd	14	573	587	602	616
7200651	FLOOR ROCKER WITH ARMS	1.2 yd	14	737	755	774	792
7110650	BASE/TABLE	-	-	489	501	513	526
7020660	SIDE CHAIR, NON-UPH	-	-	853	874	896	917
7320660	ARM CHAIR, NON-UPH	-	-	1014	1039	1065	1090
7200660	FLOOR ROCKER, NON-UPH	-	-	452	463	475	486
7200661	FLOOR ROCKER WITH ARMS, NON-UPH	-	-	617	632	648	663

Premium Fabric Grades	B	C	D	E	F	G	H	I	J	K	L
Multiply by COM Ydg	16	36	55	79	119	158	198	237	277	356	435

Available for an upcharge. List price per yard.

*eQuote is available for live configuration pricing. Contact customer service or sales representative with questions.*

# SEATING

TANNER							
Product No	Description	COM Ydg	Moist. Barrier	Zone 1	Zone 2	Zone 3	Zone 4
259101M-NA	ARMLESS CHAIR, WALLSAVING FRAME	2.75 yd	141	2620	2686	2751	2816
259102M-NA	ARMLESS LOVESEAT, WALLSAVING FRAME	5.5 yd	282	3966	4065	4164	4263
259103M-NA	ARMLESS SOFA, WALLSAVING FRAME	8.25 yd	423	4957	5081	5205	5329
259101M	CHAIR, WALLSAVING FRAME	4.25 yd	141	3116	3194	3272	3350
259102M	LOVESEAT, WALLSAVING FRAME	7 yd	282	4603	4718	4833	4948
259103M	SOFA, WALLSAVING FRAME	9.75 yd	423	5765	5909	6053	6197
259102MB	2-SEAT BOOTH, MIDBACK	5.5 yd	282	3540	3628	3717	3806
259103MB	3-SEAT BOOTH, MIDBACK	8.25 yd	423	4674	4791	4908	5025
259101HB	1-SEAT BOOTH, HIGHBACK	3.75 yd	141	2549	2613	2676	2740
259102HB	2-SEAT BOOTH, HIGHBACK	7 yd	282	4222	4328	4433	4539
259103HB	3-SEAT BOOTH, HIGHBACK	10.5 yd	423	5608	5748	5888	6029
259102B	2-SEAT BENCH	2.5 yd	282	1922	1970	2018	2066
259103B	3-SEAT BENCH	3.75 yd	423	2480	2542	2604	2666

TANNER OPTIONS							
Product No	Description			Zone 1	Zone 2	Zone 3	Zone 4
25KIT-1587	GANGING BRACKET, SEAT-TO-SEAT			44	45	46	47
25KIT-1969	GANGING BRACKET, SEAT-TO-TABLE			99	101	104	106
-	POWER FOR BOOTH TABLES/OCC TABLES					500	
-	SEATING POWER 1 UNIT					582	
-	SEATING POWER 2 UNITS					1165	
-	SEATING POWER 3 UNITS					1747	
-	SIDE CLEANOUTS (ARM MODELS)					132	

UPLAND							
Product No	Description	COM Ydg	Moist. Barrier	Zone 1	Zone 2	Zone 3	Zone 4
69UP11	SIDE CHAIR, POLY SEAT, PLASTIC BACK	-	-	601	616	631	646
69UP41	SIDE CHAIR, POLY SEAT, PLASTIC BACK, SLED BASE	-	-	764	783	802	821
69UP14	SIDE CHAIR, WIDE, POLY SEAT, PLASTIC BACK	-	-	845	866	887	908
69UP44	SIDE CHAIR, WIDE, POLY SEAT, PLASTIC BACK, SLED BASE	-	-	1008	1033	1058	1084
69UP11UB	SIDE CHAIR, POLY SEAT, UPH BACK	.5 yd	-	671	688	705	721
69UP41UB	SIDE CHAIR, POLY SEAT, UPH BACK, SLED BASE	.5 yd	-	832	853	874	894
69UP14UB	SIDE CHAIR, WIDE, POLY SEAT, UPH BACK	.75 yd	-	969	993	1017	1042
69UP44UB	SIDE CHAIR, WIDE, POLY SEAT, UPH BACK, SLED BASE	.75 yd	-	1131	1159	1188	1216
69UP11US	SIDE CHAIR, UPH SEAT, PLASTIC BACK	.5 yd	6	691	708	726	743
69UP41US	SIDE CHAIR, UPH SEAT, PLASTIC BACK, SLED BASE	.5 yd	6	854	875	897	918
69UP14US	SIDE CHAIR, WIDE, UPH SEAT, PLASTIC BACK	.75 yd	9	887	909	931	954
69UP44US	SIDE CHAIR, WIDE, UPH SEAT, PLASTIC BACK, SLED BASE	.75 yd	9	1052	1078	1105	1131
69UP11UP	SIDE CHAIR, UPH SEAT, UPH BACK	1 yd	12	760	779	798	817
69UP41UP	SIDE CHAIR, UPH SEAT, UPH BACK, SLED BASE	1 yd	12	922	945	968	991
69UP14UP	SIDE CHAIR, WIDE, UPH SEAT, UPH BACK	1.5 yd	18	1013	1038	1064	1089
69UP44UP	SIDE CHAIR, WIDE, UPH SEAT, UPH BACK, SLED BASE	1.5 yd	18	1175	1204	1234	1263

Premium Fabric Grades	B	C	D	E	F	G	H	I	J	K	L
Multiply by COM Ydg	16	36	55	79	119	158	198	237	277	356	435

Available for an upcharge. List price per yard.

*eQuote is available for live configuration pricing. Contact customer service or sales representative with questions.*

# SEATING

## UPLAND

Product No	Description	COM Ydg	Moist. Barrier	Zone 1	Zone 2	Zone 3	Zone 4
69UP01	ARM CHAIR, POLY SEAT, PLASTIC BACK	-	-	601	616	631	646
69UP02	ARM CHAIR, POLY SEAT, PLASTIC BACK, CASTERS	-	-	826	847	867	888
69UP31	ARM CHAIR, POLY SEAT, PLASTIC BACK, SLED BASE	-	-	764	783	802	821
69UP04	ARM CHAIR, WIDE, POLY SEAT, PLASTIC BACK	-	-	845	866	887	908
69UP34	ARM CHAIR, WIDE, POLY SEAT, PLASTIC BACK, SLED BASE	-	-	1008	1033	1058	1084
69UP01UB	ARM CHAIR, POLY SEAT, UPH BACK	.5 yd	-	671	688	705	721
69UP02UB	ARM CHAIR, POLY SEAT, UPH BACK, CASTERS	.5 yd	-	896	918	941	963
69UP31UB	ARM CHAIR, POLY SEAT, UPH BACK, SLED BASE	.5 yd	-	832	853	874	894
69UP04UB	ARM CHAIR, WIDE, POLY SEAT, UPH BACK	.75 yd	-	969	993	1017	1042
69UP34UB	ARM CHAIR, WIDE, POLY SEAT, UPH BACK, SLED BASE	.75 yd	-	1131	1159	1188	1216
69UP01US	ARM CHAIR, UPH SEAT, PLASTIC BACK	.5 yd	-	691	708	726	743
69UP02US	ARM CHAIR, UPH SEAT, PLASTIC BACK, CASTERS	.5 yd	6	919	942	965	988
69UP31US	ARM CHAIR, UPH SEAT, PLASTIC BACK, SLED BASE	.5 yd	6	854	875	897	918
69UP04US	ARM CHAIR, WIDE, UPH SEAT, PLASTIC BACK	.75 yd	9	887	909	931	954
69UP34US	ARM CHAIR, WIDE, UPH SEAT, PLASTIC BACK, SLED BASE	.75 yd	9	1052	1078	1105	1131
69UP01UP	ARM CHAIR, UPH SEAT, UPH BACK	1 yd	12	760	779	798	817
69UP02UP	ARM CHAIR, UPH SEAT, UPH BACK, CASTERS	1 yd	12	980	1004	1029	1054
69UP31UP	ARM CHAIR, UPH SEAT, UPH BACK, SLED BASE	1 yd	12	922	945	968	991
69UP04UP	ARM CHAIR, WIDE, UPH SEAT, UPH BACK	1.5 yd	18	1013	1038	1064	1089
69UP34UP	ARM CHAIR, WIDE, UPH SEAT, UPH BACK, SLED BASE	1.5 yd	18	1175	1204	1234	1263
69UP21	BAR STOOL WITH ARMS, POLY SEAT, PLASTIC BACK	-	-	809	829	849	870
69UP21US	BAR STOOL WITH ARMS, UPH SEAT, PLASTIC BACK	.5 yd	6	898	920	943	965
69UP21UP	BAR STOOL WITH ARMS, UPH SEAT, UPH BACK	1 yd	12	966	990	1014	1038
69UP21UB	BAR STOOL WITH ARMS, POLY SEAT, UPH BACK	.5 yd	-	878	900	922	944
69UP25	BAR STOOL, POLY SEAT, PLASTIC BACK	-	-	809	829	849	870
69UP25US	BAR STOOL, UPH SEAT, PLASTIC BACK	.5 yd	-	898	920	943	965
69UP25UP	BAR STOOL, UPH SEAT, UPH BACK	1 yd	12	966	990	1014	1038
69UP25UB	BAR STOOL, POLY SEAT, UPH BACK	.5 yd	-	878	900	922	944
69UP24	BAR STOOL WITH ARMS, WIDE, POLY SEAT, PLASTIC BACK	-	-	1050	1076	1102	1129
69UP24US	BAR STOOL WITH ARMS, WIDE, UPH SEAT, PLASTIC BACK	.75 yd	9	1097	1124	1152	1179
69UP24UP	BAR STOOL WITH ARMS, WIDE, UPH SEAT, UPH BACK	1.5 yd	18	1220	1250	1281	1312
69UP24UB	BAR STOOL, WIDE WITH ARMS, POLY SEAT, UPH BACK	.75 yd	-	1176	1205	1235	1264
69UP26	BAR STOOL, WIDE, POLY SEAT, PLASTIC BACK	-	-	1050	1076	1102	1129
69UP26US	BAR STOOL, WIDE, UPH SEAT, PLASTIC BACK	.75 yd	9	1097	1124	1152	1179
69UP26UP	BAR STOOL, WIDE, UPH SEAT, UPH BACK	1.5 yd	18	1220	1250	1281	1312
69UP26UB	BAR STOOL, WIDE, POLY SEAT, UPH BACK	.75 yd	-	1176	1205	1235	1264

## UPLAND OPTIONS

Product No	Description	Zone 1	Zone 2	Zone 3	Zone 4
-	WOOD BACK	156			
-	WALL SAVER FRAME	35			

Premium Fabric Grades	B	C	D	E	F	G	H	I	J	K	L
Multiply by COM Ydg	16	36	55	79	119	158	198	237	277	356	435

Available for an upcharge. List price per yard.

*eQuote is available for live configuration pricing. Contact customer service or sales representative with questions.*

# SEATING

UPLAND OPTIONS					
Product No	DESCRIPTION	Zone 1	Zone 2	Zone 3	Zone 4
-	UPLAND 1" EXTRA THICK SEAT FOAM			26	
-	UPLAND 1" EXTRA THICK SEAT FOAM FOR UPH BACK AND WIDER			39	
-	NICKLE PLATED GLIDE WITH NYLON CAP (PER SET)			60	
-	UPLAND CLEAR GLIDES			39	
-	SOFT CASTERS (FOR HARD SURFACE)			35	
<b>69UP14RC</b>	CORNER TABLE, MODULAR			556	
<b>69UP14ST</b>	SPACER TABLE, MODULAR			383	
<b>69UP14MT</b>	MINI SPACER TABLE, MODULAR			226	
<b>69UP14ET</b>	END TABLE, MODULAR			396	
<b>69UP14CON</b>	CONNECTING BAR GANGING			136	
<b>69UP99</b>	DOLLY, STANDARD	580	594	609	624
<b>69UP99M</b>	DOLLY, WIDE	831	852	873	893

## OCCASIONAL TABLES

### 4700 SERIES

Product No	Description	Zone 1	Zone 2	Zone 3	Zone 4
4700-01	END TABLE, 24"SQ, 22"H	1880	1927	1974	2021
4700-03	COFFEE TABLE, 24"X42"RECT, 17"H	2296	2353	2411	2468
4700-13	COFFEE TABLE W/SHELF, 24"X42"RECT, 17"H	3080	3157	3234	3311
4700-05	CONSOLE TABLE, 18"X48"RECT, 29"H	2397	2457	2517	2577
4700-15	CONSOLE TABLE W/ SHELF, 18"X48"RECT, 29"H	2975	3049	3124	3198

### 4700 SERIES OPTIONS

Product No	Description	Zones 1-4			
-	SOLID SURFACE TABLE	742			
-	SOLID SURFACE TABLE WITH SHELF	1186			

### ALLY

Product No	Description	Zone 1	Zone 2	Zone 3	Zone 4
8824DAPL18	OCCASIONAL TABLE, 24" DIA, 18" HT	1042	1068	1094	1120
8830DAPL18	OCCASIONAL TABLE, 30" DIA, 18" HT	1208	1238	1268	1299
8836DAPL18	OCCASIONAL TABLE, 36"DIA, 18"HT	1366	1400	1434	1468
8842DAPL18	OCCASIONAL TABLE, 42" DIA, 18" HT	1825	1871	1916	1962
881818SQAPL18	OCCASIONAL TABLE, 18" SQ, 18" HT	1073	1100	1127	1153
882424SQAPL18	OCCASIONAL TABLE, 24" SQ, 18" HT	1092	1119	1147	1174
883030SQAPL18	OCCASIONAL TABLE, 30"SQ, 18"H	1264	1296	1327	1359
883636SQAPL18	OCCASIONAL TABLE, 36"SQ, 18"HT	1398	1433	1468	1503
882448REAPL18	OCCASIONAL TABLE, 24"X48" RECT, 18"HT	1352	1386	1420	1453

### AMIGO ROUND/SQUARE

Product No	Description	Zone 1	Zone 2	Zone 3	Zone 4
8915DSK022	OCCASIONAL TABLE, 15"DIA, 22"H	1040	1066	1092	1118
8915DSK025	OCCASIONAL TABLE, 15"DIA, 25"H	1040	1066	1092	1118
8915DSK027	OCCASIONAL TABLE, 15"DIA, 27"H	1040	1066	1092	1118
8918DSK022	OCCASIONAL TABLE, 18"DIA, 22"H	1150	1179	1208	1236
8918DSK025	OCCASIONAL TABLE, 18"DIA, 25"H	1150	1179	1208	1236
8918DSK027	OCCASIONAL TABLE, 18"DIA, 27"H	1150	1179	1208	1236
8922DSK022	OCCASIONAL TABLE, 22"DIA, 22"H	1331	1364	1398	1431
8922DSK025	OCCASIONAL TABLE, 22"DIA, 25"H	1331	1364	1398	1431
8922DSK027	OCCASIONAL TABLE, 22"DIA 27"H	1331	1364	1398	1431
8915SQSK022	OCCASIONAL TABLE, 15"SQ, 22"H	941	965	988	1012
8915SQSK025	OCCASIONAL TABLE, 15"SQ, 25"H	941	965	988	1012
8915SQSK027	OCCASIONAL TABLE, 15"SQ, 27"H	941	965	988	1012
8918SQSK022	OCCASIONAL TABLE, 18"SQ, 22"H	1090	1117	1144	1172
8918SQSK025	OCCASIONAL TABLE, 18"SQ, 25"H	1090	1117	1144	1172
8918SQSK027	OCCASIONAL TABLE, 18"SQ, 27"H	1090	1117	1144	1172
8922SQSK022	OCCASIONAL TABLE, 22"SQ, 22"H	1274	1306	1338	1370
8922SQSK025	OCCASIONAL TABLE, 22"SQ, 25"H	1274	1306	1338	1370
8922SQSK027	OCCASIONAL TABLE, 22"SQ, 27"H	1274	1306	1338	1370

### AMIGO OPTIONS

Product No	Description	Zones 1-4			
-	SOLID SURFACE TOP	765			

## OCCASIONAL TABLES

DISC ROUND/SQUARE					
Product No	Description	Zone 1	Zone 2	Zone 3	Zone 4
8724DDISC18	DISC OCCASIONAL TABLE, 24"DIA, 18"H	1576	1615	1655	1694
8730DDISC18	DISC OCCASIONAL TABLE, 30"DIA, 18"H	1743	1787	1830	1874
8736DDISC18	DISC OCCASIONAL TABLE, 36"DIA, 18"H	1903	1951	1998	2046
8742DDISC18	DISC OCCASIONAL TABLE, 42"DIA, 18"H	2366	2425	2484	2543
8718SQDISC18	DISC OCCASIONAL TABLE, 18"SQ, 18"H	1605	1645	1685	1725
8724SQDISC18	DISC OCCASIONAL TABLE, 24"SQ, 18"H	1624	1665	1705	1746
8730SQDISC18	DISC OCCASIONAL TABLE, 30"SQ, 18"H	1798	1843	1888	1933
8736SQDISC18	DISC OCCASIONAL TABLE, 36"SQ, 18"H	1934	1982	2031	2079
DRUM & CUBE					
Product No	Description	Zone 1	Zone 2	Zone 3	Zone 4
0118D16H	DRUM OCCASIONAL TABLE, 18"DIA, 16"H	1281	1313	1345	1377
0118D18H	DRUM OCCASIONAL TABLE, 18"DIA, 18"H	1281	1313	1345	1377
0118D20H	DRUM OCCASIONAL TABLE, 18"DIA, 20"H	1281	1313	1345	1377
0118D22H	DRUM OCCASIONAL TABLE, 18"DIA, 22"H	1281	1313	1345	1377
0124D16H	DRUM OCCASIONAL TABLE, 24"DIA, 16"H	1352	1386	1420	1453
0124D18H	DRUM OCCASIONAL TABLE, 24"DIA, 18"H	1352	1386	1420	1453
0124D20H	DRUM OCCASIONAL TABLE, 24"DIA, 20"H	1352	1386	1420	1453
0124D22H	DRUM OCCASIONAL TABLE, 24"DIA, 22"H	1352	1386	1420	1453
0130D16H	DRUM OCCASIONAL TABLE, 30"DIA, 16"H	1697	1739	1782	1824
0130D18H	DRUM OCCASIONAL TABLE, 30"DIA, 18"H	1697	1739	1782	1824
0130D20H	DRUM OCCASIONAL TABLE, 30"DIA, 20"H	1697	1739	1782	1824
0130D22H	DRUM OCCASIONAL TABLE, 30"DIA, 22"H	1697	1739	1782	1824
0136D16H	DRUM OCCASIONAL TABLE, 36"DIA, 16"H	1923	1971	2019	2067
0136D18H	DRUM OCCASIONAL TABLE, 36"DIA, 18"H	1923	1971	2019	2067
0136D20H	DRUM OCCASIONAL TABLE, 36"DIA, 20"H	1923	1971	2019	2067
0136D22H	DRUM OCCASIONAL TABLE, 36"DIA, 22"H	1923	1971	2019	2067
0142D16H	DRUM OCCASIONAL TABLE, 42"DIA, 16"H	2134	2187	2241	2294
0142D18H	DRUM OCCASIONAL TABLE, 42"DIA, 18"H	2134	2187	2241	2294
0142D20H	DRUM OCCASIONAL TABLE, 42"DIA, 20"H	2134	2187	2241	2294
0142D22H	DRUM OCCASIONAL TABLE, 42"DIA, 22"H	2134	2187	2241	2294
0118SQ16H	CUBE OCCASIONAL TABLE, 18" SQ, 16" H	972	996	1021	1045
0118SQ18H	CUBE OCCASIONAL TABLE, 18" SQ, 18" H	972	996	1021	1045
0118SQ20H	CUBE OCCASIONAL TABLE, 18" SQ, 20" H	972	996	1021	1045
0118SQ22H	CUBE OCCASIONAL TABLE, 18" SQ, 22" H	972	996	1021	1045
0124SQ16H	CUBE OCCASIONAL TABLE, 24" SQ, 16" H	1025	1051	1076	1102
0124SQ18H	CUBE OCCASIONAL TABLE, 24" SQ, 18" H	1025	1051	1076	1102
0124SQ20H	CUBE OCCASIONAL TABLE, 24" SQ, 20" H	1025	1051	1076	1102
0124SQ22H	CUBE OCCASIONAL TABLE, 24" SQ, 22" H	1025	1051	1076	1102
0130SQ16H	CUBE OCCASIONAL TABLE, 30" SQ, 16" H	1286	1318	1350	1382
0130SQ18H	CUBE OCCASIONAL TABLE, 30" SQ, 18" H	1286	1318	1350	1382
0130SQ20H	CUBE OCCASIONAL TABLE, 30" SQ, 20" H	1286	1318	1350	1382
0130SQ22H	CUBE OCCASIONAL TABLE, 30" SQ, 22" H	1286	1318	1350	1382
0136SQ16H	CUBE OCCASIONAL TABLE, 36" SQ, 16" H	1496	1533	1571	1608
0136SQ18H	CUBE OCCASIONAL TABLE, 36" SQ, 18" H	1496	1533	1571	1608
0136SQ20H	CUBE OCCASIONAL TABLE, 36" SQ, 20" H	1496	1533	1571	1608
0136SQ22H	CUBE OCCASIONAL TABLE, 36" SQ, 22" H	1496	1533	1571	1608

# OCCASIONAL TABLES

## DRUM & CUBE OPTIONS

Product No	Description	Zones 1-4
-	2" ALUMINUM KICKPLATE UPCHARGE	81
-	POWER IN-SURFACE CLAMP MOUNT	687

## DUNE

Product No	Description	Zone 1	Zone 2	Zone 3	Zone 4
225242420RD	END TABLE, METAL, 24"DIA, 20"H	1510	1548	1586	1623
225242420SQ	END TABLE, METAL, 24"SQ, 20"H	1510	1548	1586	1623
225241820RE	END TABLE, METAL, 24"X18"RECT, 20"H	1510	1548	1586	1623
225484816RD	COFFEE TABLE, METAL, 48"DIA, 16"H	2494	2556	2619	2681
225484816SQ	COFFEE TABLE, METAL, 48"SQ, 16"H	2624	2690	2755	2821
225244816RE	COFFEE TABLE, METAL, 24"X48"RECT, 16"H	1772	1816	1861	1905
224242420RD	END TABLE, WOOD, 24"DIA, 20"H	2034	2085	2136	2187
224242420SQ	END TABLE, WOOD, 24"DIA, 20"H	2034	2085	2136	2187
224241820RE	END TABLE, WOOD, 24"X18"RECT, 20"H	2034	2085	2136	2187
224484816RD	COFFEE TABLE, WOOD, 48"DIA, 16"H	3019	3094	3170	3245
224484816SQ	COFFEE TABLE, WOOD, 48"SQ, 16"H	3150	3229	3308	3386
224244816RE	COFFEE TABLE, WOOD, 24"X48"RECT, 16"H	2297	2354	2412	2469

## FUSE

Product No	Description	Zone 1	Zone 2	Zone 3	Zone 4
882424SQFVST118	OCCASIONAL TABLE, 24"SQ, 18"H	1399	1434	1469	1504
883030SQFVST118	OCCASIONAL TABLE, 30"SQ, 18"H	1574	1613	1653	1692
882448REFVST118	OCCASIONAL TABLE, 24"X48"RECT, 18"H	1659	1700	1742	1783

## LEGACY

Product No	Description	Zone 1	Zone 2	Zone 3	Zone 4
7963406	LEGACY END TABLE, 21"SQ, 19"H	920	943	966	989
7963408	LEGACY COFFEE TABLE, 21"X45" RECT, 18"H	1060	1086	1113	1140
9583636	LEGACY A/V CONSOLE	1997	2047	2097	2147

## ROWAN

Product No	Description	Zone 1	Zone 2	Zone 3	Zone 4
7963419	ROWAN END TABLE, 19"SQ, 21"H	907	930	952	975
7963420	ROWAN COFFEE TABLE, 19"X31" REC, 24"H	1155	1184	1213	1242
7963630	ROWAN A/V CONSOLE	1563	1602	1641	1680

## TANNER

Product No	Description	Zone 1	Zone 2	Zone 3	Zone 4
2591ETC	END TABLE, 24"SQ, 17"H	1939	1987	2036	2084
2591ETO	END TABLE, OPEN, 24"SQ, 17"H	1986	2036	2085	2135
2591REC	COFFEE TABLE, 24"X48" RECT, 17"H	2220	2276	2331	2386
2591REOS	COFFEE TABLE, ONE SIDE OPEN, 24"X48"RECT, 17"H	2658	2724	2791	2857
2591REOB	COFFEE TABLE, TWO SIDES OPEN, 24"X48"RECT, 17"H	2723	2791	2859	2927

## TANNER OPTIONS

Product No	Description	Zones 1-4
-	POWER IN-SURFACE CLAMP MOUNT (CLOSED MODELS ONLY)	500

## OCCASIONAL TABLES

TRUMPET ROUND/SQUARE					
Product No	Description	Zone 1	Zone 2	Zone 3	Zone 4
<b>8724DTR18</b>	OCCASIONAL TABLE, 24"DIA, 18"H	1064	1091	1117	1144
<b>8730DTR18</b>	OCCASIONAL TABLE, 30"DIA, 18"H	1233	1264	1295	1325
<b>8736DTR18</b>	OCCASIONAL TABLE, 36"DIA, 18"H	1395	1430	1465	1500
<b>8742DTR18</b>	OCCASIONAL TABLE, 42"DIA, 18"H	1855	1901	1948	1994
<b>8718SQTR18</b>	OCCASIONAL TABLE, 18"SQ, 18"H	1098	1125	1153	1180
<b>8724SQTR18</b>	OCCASIONAL TABLE, 24"SQ, 18"H	1115	1143	1171	1199
<b>8730SQTR18</b>	OCCASIONAL TABLE, 30"SQ, 18"H	1288	1320	1352	1385
<b>8736SQTR18</b>	OCCASIONAL TABLE, 36"SQ, 18"H	1425	1461	1496	1532

# MULTI-PURPOSE TABLES

## ALLY

Product No	Description	Zone 1	Zone 2	Zone 3	Zone 4
8824DAPL	MULTI-PURPOSE TABLE, 24"DIA, 29"HT	1042	1068	1094	1120
8830DAPL	MULTI-PURPOSE TABLE, 30"DIA, 29"H	1208	1238	1268	1299
8836DAPL	MULTI-PURPOSE TABLE, 36"DIA, 29"HT	1366	1400	1434	1468
8842DAPL	MULTI-PURPOSE TABLE, 42"DIA, 29"H	1825	1871	1916	1962
8848DAPL	MULTI-PURPOSE TABLE, 48"DIA, 29"H	1862	1909	1955	2002
8860DAPL	MULTI-PURPOSE TABLE, 60"DIA, 29"H	2402	2462	2522	2582
882424SQAPL	MULTI-PURPOSE TABLE, 24"SQ, 29"HT	1092	1119	1147	1174
883030SQAPL	MULTI-PURPOSE TABLE, 30"SQ, 29"H	1264	1296	1327	1359
883636SQAPL	MULTI-PURPOSE TABLE, 36"SQ, 29"HT	1398	1433	1468	1503
884242SQAPL	MULTI-PURPOSE TABLE, 42"SQ, 29"H	1850	1896	1942	1989
882430REAPL	MULTI-PURPOSE TABLE, 24"X30"RECT, 29"H	1244	1275	1306	1337
882436REAPL	MULTI-PURPOSE TABLE, 24"X36" RECT, 29"H	1244	1275	1306	1337
882442REAPL	MULTI-PURPOSE TABLE, 24"X42" RECT, 29"H	1352	1386	1420	1453
882448REAPL	MULTI-PURPOSE TABLE, 24"X48"RECT, 29"H	1352	1386	1420	1453
882460REAPL	MULTI-PURPOSE TABLE, 24"X 60"RECT, 29"H	1447	1483	1519	1556
882472REAPL	MULTI-PURPOSE TABLE, 24"X 72"RECT, 29"H	1874	1921	1968	2015
883036REAPL	MULTI-PURPOSE TABLE, 30"X36"RECT, 29"H	1396	1431	1466	1501
883042REAPL	MULTI-PURPOSE TABLE, 30"X42"RECT, 29"H	1432	1468	1504	1539
883048REAPL	MULTI-PURPOSE TABLE, 30"X48"RECT, 29"H	1432	1468	1504	1539
883060REAPL	MULTI-PURPOSE TABLE, 30"X60"RECT, 29"H	1531	1569	1608	1646
883072REAPL	MULTI-PURPOSE TABLE, 30"X72"RECT, 29"H	2094	2146	2199	2251
883642REAPL	MULTI-PURPOSE TABLE, 36"X42"RECT, 29"H	1596	1636	1676	1716
883648REAPL	MULTI-PURPOSE TABLE, 36"X48"RECT, 29"H	1637	1678	1719	1760
883660REAPL	MULTI-PURPOSE TABLE, 36"X60"RECT, 29"H	1796	1841	1886	1931
883672REAPL	MULTI-PURPOSE TABLE, 36"X72"RECT, 29"H	2189	2244	2298	2353

## ALLY OPTIONS

Product No	Description	Zones 1-4
-	HARD CASTERS - TABLES < 72" (SOFT SURFACES) - PER TABLE	145
-	HARD CASTERS - TABLES >=72" (SOFT SURFACES) - PER TABLE	196
-	SOFT CASTERS - TABLES < 72" (SOFT SURFACES) - PER TABLE	315
-	SOFT CASTERS - TABLES >= 72" (HARD SURFACES) - PER TABLE	420
-	FOLDING TABLE OPTION FOR TABLES < 72"	987
-	FOLDING TABLE OPTION FOR TABLES >= 72"	1232
CTRS	ROUND GROMMET	42
CTRG	OVAL GROMMET	67
CSC	SEAM CONNECTOR	155
CWMT	SNAP TO LEG WIRE MANAGER	64
VELCROWIREMGR	VELCRO WIRE MANAGER	21
WIREMGR	PVC UNDER TABLE WIRE MANAGER	61
-	POWER - IN-SURFACE CLAMP MOUNT	687
-	POWER - EDGE CLAMP-ON	596

## DISC

Product No	Description	Zone 1	Zone 2	Zone 3	Zone 4
8724DDISC29	DISC MULTI-PURPOSE TABLE, 24"DIA, 29"H	1576	1615	1655	1694
8730DDISC29	DISC MULTI-PURPOSE TABLE, 30"DIA, 29"H	1743	1787	1830	1874

## MULTI-PURPOSE TABLES

DISC					
Product No	Description	Zone 1	Zone 2	Zone 3	Zone 4
8730SQDISC29	DISC MULTI- PURPOSE TABLE, 30"SQ, 29"H	1798	1843	1888	1933
8736DDISC29	DISC MULTI-PURPOSE TABLE, 36"DIA, 29"H	1903	1951	1998	2046
8736SQDISC29	DISC MULTI-PURPOSE TABLE, 36"SQ, 29"H	1934	1982	2031	2079
8742DDISC29	DISC MULTI-PURPOSE TABLE, 42"DIA, 29"H	2366	2425	2484	2543
8748DDISC29	DISC MULTI-PURPOSE TABLE, 48"DIA, 29"H	2404	2464	2524	2584
FUSE					
Product No	Description	Zone 1	Zone 2	Zone 3	Zone 4
882424SQFVST129	MULTI-PURPOSE TABLE, 24"SQ, 29"H	1399	1434	1469	1504
883030SQFVST129	MULTI-PURPOSE TABLE, 30"SQ, 29"H	1575	1614	1654	1693
883636SQFVST129	MULTI-PURPOSE TABLE, 36"SQ, 29"H	1705	1748	1790	1833
881848REFVST129	MULTI-PURPOSE TABLE, 18"X48"RECT, 29"H	1585	1625	1664	1704
881860REFVST129	MULTI-PURPOSE TABLE, 18"X60"RECT,29"H	1659	1700	1742	1783
881872REFVST129	MULTI-PURPOSE TABLE, 18"X72"RECT,29"H	1757	1801	1845	1889
882430REFVST129	MULTI-PURPOSE TABLE, 24"X30"RECT,29"H	1552	1591	1630	1668
882436REFVST129	MULTI-PURPOSE TABLE, 24"X36"RECT, 29"H	1552	1591	1630	1668
882442REFVST129	MULTI-PURPOSE TABLE, 24"X42"RECT, 29"H	1659	1700	1742	1783
882448REFVST129	MULTI-PURPOSE TABLE, 24"X48"RECT,29"H	1659	1700	1742	1783
882460REFVST129	MULTI-PURPOSE TABLE, 24"X60"RECT,29"H	1757	1801	1845	1889
882472REFVST129	MULTI-PURPOSE TABLE, 24"X72"RECT,29"H	1998	2048	2098	2148
883036REFVST129	MULTI-PURPOSE TABLE, 30"X36"RECT,29"H	1705	1748	1790	1833
883042REFVST129	MULTI-PURPOSE TABLE, 30"X42"RECT, 29"H	1742	1786	1829	1873
883048REFVST129	MULTI-PURPOSE TABLE, 30"X48"RECT, 29"H	1742	1786	1829	1873
883060REFVST129	MULTI-PURPOSE TABLE, 30"X60"RECT, 29"H	1839	1885	1931	1977
883072REFVST129	MULTI-PURPOSE TABLE, 30"X72"RECT, 29"H	2217	2272	2328	2383
883642REFVST129	MULTI-PURPOSE TABLE, 36"X42"RECT, 29"H	1906	1954	2001	2049
883648REFVST129	MULTI-PURPOSE TABLE, 36"X48"RECT, 29"H	1947	1996	2044	2093
883660REFVST129	MULTI-PURPOSE TABLE, 36"X60"RECT, 29"H	2105	2158	2210	2263
883672REFVST129	MULTI-PURPOSE TABLE, 36"X72"RECT, 29"H	2315	2373	2431	2489
FUSE OPTIONS					
Product No	Description	Zones 1-4			
-	HARD CASTERS - TABLES < 72" (SOFT SURFACES) - PER TABLE	145			
-	SOFT CASTERS - TABLES < 72" (SOFT SURFACES) - PER TABLE	315			
VSC	SEAM CONNECTOR	143			
WIREMGR	PVC UNDER TABLE WIRE MANAGER	61			
CTRS	ROUND GROMMET	42			
CTRG	OVAL GROMMET	67			
-	POWER - IN-SURFACE CLAMP MOUNT	687			
ROWAN					
Product No	Description	Zone 1	Zone 2	Zone 3	Zone 4
7964076	ROWAN DINING TABLE, 36"SQ, 30"H	1152	1181	1210	1238

# MULTI-PURPOSE TABLES

## SUMMIT

Product No	Description	Zone 1	Zone 2	Zone 3	Zone 4
1942DPKD30	MULTI-PURPOSE TABLE, 42"DIA, 30"H	4263	4370	4476	4583
1948DPKD30	MULTI-PURPOSE TABLE, 48"DIA, 30"H	4305	4413	4520	4628
1960DPKD30	MULTI-PURPOSE TABLE, 60"DIA, 30"H	4930	5053	5176	5300
1936SQPKD30	MULTI-PURPOSE TABLE, 36"SQ, 30"H	3770	3864	3958	4053
1942SQPKD30	MULTI-PURPOSE TABLE, 42"SQ, 30"H	4291	4398	4506	4613
1948SQPKD30	MULTI-PURPOSE TABLE, 48"SQ, 30"H	4572	4686	4801	4915
1960SQPKD30	MULTI-PURPOSE TABLE, 60"SQ, 30"H	4900	5022	5145	5268
193672REPKD30	MULTI-PURPOSE TABLE, 36"X72"RECT, 30"H	4469	4581	4692	4804
193684REPKD30	MULTI-PURPOSE TABLE, 36"X84"RECT, 30"H	5093	5220	5348	5475
193696REPKD30	MULTI-PURPOSE TABLE, 36"X96"RECT, 30"H	5109	5237	5364	5492
1936108REPKD30	MULTI-PURPOSE TABLE, 36"X108"RECT, 30"H	5352	5486	5620	5753
1936120REPKD30	MULTI-PURPOSE TABLE, 36"X120"RECT, 30"H	7050	7226	7402	7579
194272REPKD30	MULTI-PURPOSE TABLE, 42"X72"RECT, 30"H	5009	5134	5259	5385
194284REPKD30	MULTI-PURPOSE TABLE, 42"X84"RECT, 30"H	5552	5691	5830	5968
194296REPKD30	MULTI-PURPOSE TABLE, 42"X96"RECT, 30"H	5647	5788	5929	6071
1942108REPKD30	MULTI-PURPOSE TABLE, 42"X108"RECT, 30"H	6008	6158	6308	6459
1942120REPKD30	MULTI-PURPOSE TABLE, 42"X120"REC, 30"H	7866	8063	8259	8456
194872REPKD30	MULTI-PURPOSE TABLE, 48"X72"RECT, 30"H	5189	5319	5448	5578
194884REPKD30	MULTI-PURPOSE TABLE, 48"X84"RECT, 30"H	5553	5692	5831	5969
194896REPKD30	MULTI-PURPOSE TABLE, 48"X96"RECT, 30"H	5647	5788	5929	6071
1948108REPKD30	MULTI-PURPOSE TABLE, 48"X108"RECT, 30"H	6047	6198	6349	6501
1948120REPKD30	MULTI-PURPOSE TABLE, 48"X120"RECT, 30"H	7903	8101	8298	8496
196072REPKD30	MULTI-PURPOSE TABLE, 60"X72"RECT, 30"H	5647	5788	5929	6071
196084REPKD30	MULTI-PURPOSE TABLE, 60"X84"RECT, 30"H	6042	6193	6344	6495
196096REPKD30	MULTI-PURPOSE TABLE, 60"X96"RECT, 30"H	6273	6430	6587	6743
1960108REPKD30	MULTI-PURPOSE TABLE, 60"X108"RECT, 30"H	6877	7049	7221	7393
1960120REPKD30	MULTI-PURPOSE TABLE, 60"X120"RECT, 30"H	8796	9016	9236	9456
1942DPKD36	COUNTER HEIGHT MULTI-PURPOSE TABLE, 42"DIA, 36"H	4313	4421	4529	4636
1948DPKD36	COUNTER HEIGHT MULTI-PURPOSE TABLE, 48"DIA, 36"H	4355	4464	4573	4682
1960DPKD36	COUNTER HEIGHT MULTI-PURPOSE TABLE, 60"DIA, 36"H	4979	5103	5228	5352
1936SQPKD36	COUNTER HEIGHT MULTI-PURPOSE TABLE, 36"SQ, 36"H	3819	3914	4010	4105
1942SQPKD36	COUNTER HEIGHT MULTI-PURPOSE TABLE, 42"SQ, 36"H	4339	4447	4556	4664
1948SQPKD36	COUNTER HEIGHT MULTI-PURPOSE TABLE, 48"SQ, 36"H	4624	4740	4855	4971
1960SQPKD36	COUNTER HEIGHT MULTI-PURPOSE TABLE, 60"SQ, 36"H	4949	5073	5196	5320
193672REPKD36	COUNTER HEIGHT MULTI-PURPOSE TABLE 36"X72"RECT, 36"H	4516	4629	4742	4855
193684REPKD36	COUNTER HEIGHT MULTI-PURPOSE TABLE, 36"X84"RECT, 36"H	5143	5272	5400	5529
193696REPKD36	COUNTER HEIGHT MULTI-PURPOSE TABLE, 36"X96"RECT, 36"H	5158	5287	5416	5545
1936108REPKD36	COUNTER-HEIGHT MULTI-PURPOSE TABLE, 36"X108"RECT, 36"H	5404	5539	5674	5809
1936120REPKD36	COUNTER HEIGHT MULTI-PURPOSE TABLE, 36"X120"RECT, 36"H	7130	7308	7486	7665
194272REPKD36	COUNTER HEIGHT MULTI-PURPOSE TABLE, 42"X72"RECT, 36"H	5062	5189	5315	5442
194284REPKD36	COUNTER HEIGHT MULTI-PURPOSE TABLE, 42"X84"RECT, 36"H	5602	5742	5882	6022
194296REPKD36	COUNTER HEIGHT MULTI-PURPOSE TABLE, 42"X96"RECT, 36"H	5700	5842	5985	6128
1942108REPKD36	COUNTER HEIGHT MULTI-PURPOSE TABLE, 42"X108"RECT, 36"H	6059	6210	6362	6513
1942120REPKD36	COUNTER HEIGHT MULTI-PURPOSE TABLE, 42"X120"RECT, 36"H	7942	8141	8339	8538
194872REPKD36	COUNTER HEIGHT MULTI-PURPOSE TABLE, 48"X72"RECT, 36"H	5078	5205	5332	5459
194884REPKD36	COUNTER HEIGHT MULTI-PURPOSE TABLE, 48"X84"RECT, 36"H	5603	5743	5883	6023
194896REPKD36	COUNTER HEIGHT MULTI-PURPOSE TABLE, 48"X96"RECT, 36"H	5700	5842	5985	6128

# MULTI-PURPOSE TABLES

SUMMIT					
Product No	Description	Zone 1	Zone 2	Zone 3	Zone 4
1948108REPKD36	COUNTER HEIGHT MULTI-PURPOSE TABLE, 48"X108"RECT, 36"H	6098	6250	6403	6555
1948120REPKD36	COUNTER HEIGHT MULTI-PURPOSE TABLE, 48"X120"RECT, 36"H	7980	8180	8379	8578
196072REPKD36	COUNTER HEIGHT MULTI-PURPOSE TABLE, 60"X72"RECT, 36"H	5700	5842	5985	6128
196084REPKD36	COUNTER HEIGHT MULTI-PURPOSE TABLE, 60"X84"RECT, 36"H	6095	6247	6400	6552
196096REPKD36	COUNTER HEIGHT MULTI-PURPOSE TABLE, 60"X96"RECT, 36"H	6325	6483	6641	6799
1960108REPKD36	COUNTER HEIGHT MULTI-PURPOSE TABLE, 60"X108"RECT, 36"H	6927	7100	7273	7447
1960120REPKD36	COUNTER HEIGHT MULTI-PURPOSE TABLE, 60"X120"RECT, 36"H	8872	9094	9316	9537
1942DPKD42	BAR HEIGHT MULTI-PURPOSE TABLE, 42"DIA, 42"H	4357	4466	4575	4684
1948DPKD42	BAR HEIGHT MULTI-PURPOSE TABLE, 48"DIA, 42"H	4401	4511	4621	4731
1960DPKD42	BAR HEIGHT MULTI-PURPOSE TABLE, 60"DIA, 42"H	5026	5152	5277	5403
1936SQPKD42	BAR HEIGHT MULTI-PURPOSE TABLE, 36"SQ, 42"H	3867	3964	4060	4157
1942SQPKD42	BAR HEIGHT MULTI-PURPOSE TABLE, 42"SQ, 42"H	4385	4495	4604	4714
1948SQPKD42	BAR HEIGHT MULTI-PURPOSE TABLE, 48"SQ, 42"H	4670	4787	4904	5020
1960SQPKD42	BAR HEIGHT MULTI-PURPOSE TABLE, 60"SQ, 42"H	4996	5121	5246	5371
193672REPKD42	BAR HEIGHT MULTI-PURPOSE TABLE, 36"X72"RECT, 42"H	4563	4677	4791	4905
193684REPKD42	BAR HEIGHT MULTI-PURPOSE TABLE, 36"X84"RECT, 42"H	5189	5319	5448	5578
193696REPKD42	BAR HEIGHT MULTI-PURPOSE TABLE, 36"X96"RECT, 42"H	5205	5335	5465	5595
1936108REPKD42	BAR HEIGHT MULTI-PURPOSE TABLE, 36"X108"RECT, 42"H	5448	5584	5720	5857
1936120REPKD42	BAR HEIGHT MULTI-PURPOSE TABLE, 36"X120"RECT, 42"H	7195	7375	7555	7735
194272REPKD42	BAR HEIGHT MULTI-PURPOSE TABLE, 42"X72"RECT, 42"H	5108	5236	5363	5491
194284REPKD42	BAR HEIGHT MULTI-PURPOSE TABLE, 42"X84"RECT, 42"H	5646	5787	5928	6069
194296REPKD42	BAR HEIGHT MULTI-PURPOSE TABLE, 42"X96"RECT, 42"H	5744	5888	6031	6175
1942108REPKD42	BAR HEIGHT MULTI-PURPOSE TABLE, 42"X108"RECT, 42"H	6102	6255	6407	6560
1942120REPKD42	BAR HEIGHT MULTI-PURPOSE TABLE, 42"X120"RECT, 42"H	8008	8208	8408	8609
194872REPKD42	BAR HEIGHT MULTI-PURPOSE TABLE, 48"X72"RECT, 42"H	5122	5250	5378	5506
194884REPKD42	BAR HEIGHT MULTI-PURPOSE TABLE, 48"X84"RECT, 42"H	5647	5788	5929	6071
194896REPKD42	BAR HEIGHT MULTI-PURPOSE TABLE, 48"X96"RECT, 42"H	5744	5888	6031	6175
1948108REPKD42	BAR HEIGHT MULTI-PURPOSE TABLE, 48"X108"RECT, 42"H	6143	6297	6450	6604
1948120REPKD42	BAR HEIGHT MULTI-PURPOSE TABLE, 48"X120"RECT, 42"H	8048	8249	8450	8652
196072REPKD42	BAR HEIGHT MULTI-PURPOSE TABLE, 60"X72"RECT, 42"H	5744	5888	6031	6175
196084REPKD42	BAR HEIGHT MULTI-PURPOSE TABLE, 60"X84"RECT, 42"H	6138	6291	6445	6598
196096REPKD42	BAR HEIGHT MULTI-PURPOSE TABLE, 60"X96"RECT, 42"H	6368	6527	6686	6846
1960108REPKD42	BAR HEIGHT MULTI-PURPOSE TABLE, 60"X108"RECT, 42"H	6973	7147	7322	7496
1960120REPKD42	BAR HEIGHT MULTI-PURPOSE TABLE, 60"X120"RECT, 42"H	8939	9162	9386	9609
SUMMIT OPTIONS					
Product No	Description	Zones 1-4			
-	SPLIT TOP UPCHARGE FOR SUMMIT	199			
CTRS	ROUND GROMMET	42			
CTRG	OVAL GROMMET	67			
VELCROWIREMGR	VELCRO WIRE MANAGEMENT	21			
VERTICALWIREMGR	MAGNETIC VERTICAL WIRE MANAGER	276			
WIREMGR	PVC UNDER TABLE WIRE MANAGER	61			
-	POWER-IN-SURFACE CLAMP-MOUNT	687			
-	POWER - EDGE CLAMP-ON	596			

## MULTI-PURPOSE TABLES

### TANNER

Product No	Description	Zone 1	Zone 2	Zone 3	Zone 4
2524X24SQBT	BOOTH TABLE, 24"SQ, 29"H	1815	1860	1906	1951
2530X46RETBT	BOOTH TABLE, 30"X46"RECT, 29"H	2683	2750	2817	2884
2530X69RETBT	BOOTH TABLE, 30"X69"RECT, 29"H	4626	4742	4857	4973
2542X46RETBT	BOOTH TABLE, 42"X46"RECT, 29"H	4069	4171	4272	4374
2542X69RETBT	BOOTH TABLE, 42"X69"RECT, 29"H	6201	6356	6511	6666

### TANNER OPTIONS

Product No	Description	Zones 1-4			
-	POWER IN-SURFACE CLAMP MOUNT	500			

### TAPERED LEG

Product No	Description	Zone 1	Zone 2	Zone 3	Zone 4
7954032	TAPERED LEG TABLE,42" ROUND, 30" H	1674	1716	1758	1800
7954033	TAPERED LEG TABLE,36" SQUARE, 30" H	1410	1445	1480	1516
7954034	TAPERED LEG TABLE, MEDIUM RECTANGLE 36"X60"X30" H	1595	1635	1675	1715
7954036	TAPERED LEG TABLE, LARGE RECTANGLE 36"X84"X30" H	2008	2058	2108	2159

### TRUMPET

Product No	Description	Zone 1	Zone 2	Zone 3	Zone 4
8724DTR29	MULTI-PURPOSE TABLE, 24"DIA, 29"H	1064	1091	1117	1144
8730DTR29	MULTI-PURPOSE TABLE, 30"DIA, 29"H	1233	1264	1295	1325
8736DTR29	MULTI-PURPOSE TABLE, 36"DIA, 29"H	1395	1430	1465	1500
8742DTR29	MULTI-PURPOSE TABLE, 42"DIA, 29"H	1855	1901	1948	1994
8748DTR29	MULTI-PURPOSE TABLE, 48"DIA, 29"H	1893	1940	1988	2035
8724SQTR29	MULTI-PURPOSE TABLE, 24"SQ, 29"H	1115	1143	1171	1199
8730SQTR29	MULTI-PURPOSE TABLE, 30"SQ, 29"H	1225	1256	1286	1317
8736SQTR29	MULTI-PURPOSE TABLE, 36"SQ, 29"H	1425	1461	1496	1532

### TUBULAR

Product No	Description	Zone 1	Zone 2	Zone 3	Zone 4
8624DX	MULTI-PURPOSE TABLE, 24"DIA, 29"H, X-BASE	855	876	898	919
8630DX	MULTI-PURPOSE TABLE, 30"DIA, 29"H, X-BASE	1027	1053	1078	1104
8636DX	MULTI-PURPOSE TABLE, 36"DIA, 29"H, X-BASE	1190	1220	1250	1279
8642DX	MULTI-PURPOSE TABLE, 42"DIA, X-BASE	1658	1699	1741	1782
8648DX	MULTI-PURPOSE TABLE, 48"DIA,29"H, X-BASE	1697	1739	1782	1824
8624SQX	MULTI-PURPOSE TABLE, 24"SQ, 29"H, X-BASE	907	930	952	975
8630SQX	MULTI-PURPOSE TABLE, 30"SQ, 29"H, X-BASE	1084	1111	1138	1165
8636SQX	MULTI-PURPOSE TABLE, 36"SQ, 29"H, X-BASE	1221	1252	1282	1313
8642SQX	MULTI-PURPOSE TABLE, 42"SQ, 29"H, X-BASE	1937	1985	2034	2082
862430REX	MULTI-PURPOSE TABLE, 24"X30"RECT, 29"H X-BASE	1065	1092	1118	1145
862436REX	MULTI-PURPOSE TABLE, 24"X36"RECT, 29"H, X-BASE	1065	1092	1118	1145
863036REX	MULTI-PURPOSE TABLE, 30"X36"RECT, 29"H X-BASE	1221	1252	1282	1313
863042REX	MULTI-PURPOSE TABLE, 30"X42"RECT, 29"H X-BASE	1257	1288	1320	1351
863048REX	MULTI-PURPOSE TABLE, 30"X48"RECT, 29"H, X-BASE	1257	1288	1320	1351
8624DX41	BAR HEIGHT TABLE, 24"DIA, 41"H, X-BASE	920	943	966	989
8630DX41	BAR HEIGHT TABLE, 30"DIA, 41"H, X-BASE	1091	1118	1146	1173
8636DX41	BAR HEIGHT TABLE, 36"DIA, 41"H, X-BASE	1256	1287	1319	1350

# MULTI-PURPOSE TABLES

TUBULAR					
Product No	Description	Zone 1	Zone 2	Zone 3	Zone 4
8624SQX41	BAR HEIGHT TABLE, 24"SQ, 41"H, X-BASE	972	996	1021	1045
8630SQX41	BAR HEIGHT TABLE, 30"SQ, 41"H, X-BASE	1150	1179	1208	1236
8636SQX41	BAR HEIGHT TABLE, 36"SQ, 41"H, X-BASE	1286	1318	1350	1382
8642DX4	MULTI-PURPOSE TABLE, 42"DIA, 29"H, 4-COLUMN X-BASE	1982	2032	2081	2131
8648DX4	MULTI-PURPOSE TABLE, 48"DIA, 29"H, 4-COLUMN X-BASE	2021	2072	2122	2173
8654DX4	MULTI-PURPOSE TABLE, 54"DIA, 29"H, 4-COLUMN X-BASE	2497	2559	2622	2684
8660DX4	MULTI-PURPOSE TABLE, 60"DIA, 29"H, 4-COLUMN X-BASE	2572	2636	2701	2765
8642SQX4	MULTI-PURPOSE TABLE, 42"SQ, 29"H, 4-COLUMN X-BASE	2005	2055	2105	2155
8648SQX4	MULTI-PURPOSE TABLE, 48"SQ, 29"H, 4-COLUMN X-BASE	2261	2318	2374	2431
8654SQX4	MULTI-PURPOSE TABLE, 54"SQ, 29"H, 4-COLUMN X-BASE	2502	2565	2627	2690
8660SQX4	MULTI-PURPOSE TABLE, 60"SQ, 29"H, 4-COLUMN X-BASE	2555	2619	2683	2747
862430RET	MULTI-PURPOSE TABLE, 24"X30"RECT, 29"H, T-BASE	1248	1279	1310	1342
862436RET	MULTI-PURPOSE TABLE, 24"X36"RECT, 29"H, T-BASE	1248	1279	1310	1342
862442RET	MULTI-PURPOSE TABLE, 24"X42"RECT, 29"H T-BASE	1357	1391	1425	1459
862448RET	MULTI-PURPOSE TABLE, 24"X48"RECT, 29"H, T-BASE	1357	1391	1425	1459
862454RET	MULTI-PURPOSE TABLE, 24"X54"RECT, 29"H T-BASE	1456	1492	1529	1565
862460RET	MULTI-PURPOSE TABLE, 24"X60"RECT, 29"H T-BASE	1456	1492	1529	1565
862466RET	MULTI-PURPOSE TABLE, 24"X66"RECT, 29"H T-BASE	1701	1744	1786	1829
862472RET	MULTI-PURPOSE TABLE, 24"X72"RECT, 29"H T-BASE	1701	1744	1786	1829
863036RET	MULTI-PURPOSE TABLE, 30"X36"RECT, 29"H, T-BASE	1404	1439	1474	1509
863042RET	MULTI-PURPOSE TABLE, 30"X42"RECT, 29"H T-BASE	1440	1476	1512	1548
863048RET	MULTI-PURPOSE TABLE, 30"X48"RECT, 29"H, T-BASE	1440	1476	1512	1548
863054RET	MULTI-PURPOSE TABLE, 30"X54"RECT, 29"H T-BASE	1535	1573	1612	1650
863060RET	MULTI-PURPOSE TABLE, 30"X60"RECT, 29"H T-BASE	1535	1573	1612	1650
863066RET	MULTI-PURPOSE TABLE, 30"X66"RECT, 29"H, T-BASE	1829	1875	1920	1966
863072RET	MULTI-PURPOSE TABLE, 30"X72"RECT, 29"H T-BASE	1925	1973	2021	2069
863078RET	MULTI-PURPOSE TABLE, 30"X78"RECT, 29"H T-BASE	2303	2361	2418	2476
863084RET	MULTI-PURPOSE TABLE, 30"X84"RECT, 29"H T-BASE	2303	2361	2418	2476
863090RET	MULTI-PURPOSE TABLE, 30"X90"RECT, 29"H T-BASE	2339	2397	2456	2514
863096RET	MULTI-PURPOSE TABLE, 30"X96"RECT, 29"H, T-BASE	2339	2397	2456	2514
863642RET	MULTI-PURPOSE TABLE, 36"X42"RECT, 29"H, T-BASE	1609	1649	1689	1730
863648RET	MULTI-PURPOSE TABLE, 36" X 48" RECT, 29"H, T-BASE	1649	1690	1731	1773
863660RET	MULTI-PURPOSE TABLE, 36"X60"RECT, 29"H, T-BASE	1812	1857	1903	1948
863666RET	MULTI-PURPOSE TABLE, 36"X66"RECT, 29"H, T-BASE	1960	2009	2058	2107
863672RET	MULTI-PURPOSE TABLE, 36"X72"RECT, 29"H, T-BASE	2024	2075	2125	2176
863678RET	MULTI-PURPOSE TABLE, 36"X78"RECT, 29"H, T-BASE	2587	2652	2716	2781
863684RET	MULTI-PURPOSE TABLE, 36"X84"RECT, 29"H, T-BASE	2587	2652	2716	2781
863690RET	MULTI-PURPOSE TABLE, 36" X 90" RECT, 29"H, T-BASE	2597	2662	2727	2792
863696RET	MULTI-PURPOSE TABLE, 36"X96"RECT, 29"H, T-BASE	2597	2662	2727	2792
863654RTT	MULTI-PURPOSE TABLE, 36"X54" RACETRACK, 29"H, T-BASE	1905	1953	2000	2048
863660RTT	MULTI-PURPOSE TABLE, 36"X60" RACETRACK, 29"H, T-BASE	1905	1953	2000	2048
863666RTT	MULTI-PURPOSE TABLE, 36"X66" RACETRACK, 29"H, T-BASE	2171	2225	2280	2334
863672RTT	MULTI-PURPOSE TABLE, 36"X72" RACETRACK, 29"H, T-BASE	2171	2225	2280	2334
863678RTT	MULTI-PURPOSE TABLE, 36"X78" RACETRACK, 29"H, T-BASE	2615	2680	2746	2811
863684RTT	MULTI-PURPOSE TABLE, 36"X84" RACETRACK, 29"H, T-BASE	2615	2680	2746	2811
863690RTT	MULTI-PURPOSE TABLE, 36" X 90" RACETRACK, 29"H, T-BASE	2620	2686	2751	2816
863696RTT	MULTI-PURPOSE TABLE, 36"X96" RACETRACK, 29"H, T-BASE	2620	2686	2751	2816

# MULTI-PURPOSE TABLES

## TUBULAR

Product No	Description	Zone 1	Zone 2	Zone 3	Zone 4
863054BT	MULTI-PURPOSE TABLE, 30"X54" BULLET, 29"H, T-BASE	1740	1784	1827	1870
863060BT	MULTI-PURPOSE TABLE, 30"X60" BULLET, 29"H, T-BASE	1827	1873	1918	1964
863654BT	MULTI-PURPOSE TABLE, 36"X54" BULLET, 29"H, T-BASE	1944	1993	2041	2090
863660BT	MULTI-PURPOSE TABLE, 36"X60" BULLET, 29"H, T-BASE	1944	1993	2041	2090
863672BT	MULTI-PURPOSE TABLE, 36"X72" BULLET, 29"H, T-BASE	2169	2223	2277	2332
862448HT	MULTI-PURPOSE TABLE, 24"X48" HALF MOON, 29"H, T-BASE	1382	1417	1451	1486
863060HT	MULTI-PURPOSE TABLE, 30"X60" HALF MOON, 29"H, T-BASE	1641	1682	1723	1764
863672HT	MULTI-PURPOSE TABLE, 36"X72" HALF MOON, 29"H, T-BASE	2169	2223	2277	2332
863060TPT	MULTI-PURPOSE TABLE, 30"X60" TRAPEZOID, 29"H, T-BASE	1740	1784	1827	1870
863672TPT	MULTI-PURPOSE TABLE, 36"X72" TRAPEZOID, 29"H, T-BASE	2169	2223	2277	2332
863666RET2	MULTI-PURPOSE TABLE, 36"X66" RECT, 29"H, DOUBLE COLUMN T-BASE	2295	2352	2410	2467
863672RET2	MULTI-PURPOSE TABLE, 36"X72"RECT, 29"H, DOUBLE COLUMN T-BASE	2356	2415	2474	2533
863678RET2	MULTI-PURPOSE TABLE, 36"X78"RECT, 29"H, DOUBLE COLUMN T-BASE	2920	2993	3066	3139
863684RET2	MULTI-PURPOSE TABLE, 36"X84"RECT, 29"H, DOUBLE COLUMN T-BASE	2920	2993	3066	3139
863690RET2	MULTI-PURPOSE TABLE, 36" X 90" RECT, 29"H, DOUBLE COLUMN T-BASE	2931	3004	3078	3151
863696RET2	MULTI-PURPOSE TABLE, 36"X96"RECT, 29"H, DOUBLE COLUMN T-BASE	2931	3004	3078	3151
864278RET2	MULTI-PURPOSE TABLE, 42"X78"RECT, 29"H, DOUBLE COLUMN T-BASE	3329	3412	3495	3579
864284RET2	MULTI-PURPOSE TABLE, 42"X84"RECT, 29"H, DOUBLE COLUMN T-BASE	3329	3412	3495	3579
863654RTT2	MULTI-PURPOSE TABLE, 36"X54", RACETRACK, 29"H, DOUBLE COLUMN T-BASE	2242	2298	2354	2410
863660RTT2	MULTI-PURPOSE TABLE, 36"X60" RACETRACK, 29"H, DOUBLE COLUMN T-BASE	2242	2298	2354	2410
863666RTT2	MULTI-PURPOSE TABLE, 36"X66" RACETRACK, 29"H, DOUBLE COLUMN T-BASE	2507	2570	2632	2695
863672RTT2	MULTI-PURPOSE TABLE, 36"X72" RACETRACK, 29"H, DOUBLE COLUMN T-BASE	2507	2570	2632	2695
863678RTT2	MULTI-PURPOSE TABLE, 36"X78" RACETRACK, 29"H, DOUBLE COLUMN T-BASE	2951	3025	3099	3172
863684RTT2	MULTI-PURPOSE TABLE, 36"X84" RACETRACK, 29"H, DOUBLE COLUMN T-BASE	2951	3025	3099	3172
863690RTT2	MULTI-PURPOSE TABLE, 36" X 90" RACETRACK, DOUBLE COLUMN T-BASE	2955	3029	3103	3177
863696RTT2	MULTI-PURPOSE TABLE, 36"X96" RACETRACK, 29"H, DOUBLE COLUMN T-BASE	2955	3029	3103	3177
864278RTT2	MULTI-PURPOSE TABLE, 42"X78" RACETRACK, 29"H, DOUBLE COLUMN T-BASE	3354	3438	3522	3606
864284RTT2	MULTI-PURPOSE TABLE, 42"X84" RACETRACK, 29"H, DOUBLE COLUMN T-BASE	3354	3438	3522	3606
864878RTT2	MULTI-PURPOSE TABLE, 48"X78" RACETRACK, 29"H, DOUBLE COLUMN T-BASE	3358	3442	3526	3610
864884RTT2	MULTI-PURPOSE TABLE, 48"X84" RACETRACK, 29"H, DOUBLE COLUMN T-BASE	3358	3442	3526	3610
8624RC90	CONNECTOR TABLE, 24" X 24" RADIUS	651	667	684	700
8630RC90	CONNECTOR TABLE, 30" X 30" RADIUS	830	851	872	892
863036CRC90T	CONNECTOR TABLE, 30" X 36" CRESCENT	1329	1362	1395	1429
863642CRC90T	CONNECTOR TABLE, 36" X 42" CRESCENT	1925	1973	2021	2069

## TUBULAR OPTIONS

Product No	Description	Zones 1-4
-	HARD CASTERS - TABLES < 72" (SOFT SURFACES) - PER TABLE	145
-	HARD CASTERS - TABLES >=72" (SOFT SURFACES) - PER TABLE	196
-	SOFT CASTERS - TABLES < 72" (SOFT SURFACES) - PER TABLE	315
-	SOFT CASTERS - TABLES >= 72" (HARD SURFACES) - PER TABLE	420
-	FLIP TOP OPTION TABLES (1 BASE)	240
-	FLIP TOP OPTION (2 BASE)	480
-	FOLDING TABLE OPTION FOR TABLES < 72"	987
-	FOLDING TABLE OPTION FOR TABLES >= 72"	1232
-	TUBULAR WHEELCHAIR HEIGHT OPTION (ADA)	64
-	POWER IN-SURFACE CLAMP MOUNT	687

## MULTI-PURPOSE TABLES

TUBULAR OPTIONS		
Product No	Description	Zones 1-4
-	POWER - EDGE CLAMP-ON	596
<b>CWMT</b>	SNAP TO LEG WIRE MANAGER	64
<b>VELCROWIREMGR</b>	VELCRO WIRE MANAGER	21
<b>CTRS</b>	ROUND GROMMET	42
<b>CTRG</b>	OVAL GROMMET	67
<b>CSC</b>	SEAM CONNECTOR	155
-	MODESTY PANEL	482

# BEDS

## CAMDEN

Product No	Description	Zone 1	Zone 2	Zone 3	Zone 4
9816434	HEAD PANEL, LAMINATE, TWIN	374	383	393	402
9816436	HEAD PANEL, LAMINATE, FULL	490	502	514	527
9616422	RAISED BED, TWIN XL	1259	1290	1322	1353
9616421	RAISED BED, TWIN	1167	1196	1225	1255
9616420	RAISED BED, FULL	1390	1425	1460	1494
9616440	HEAD PANEL, METAL, TWIN	286	293	300	307
9616441	HEAD PANEL, METAL, FULL	352	361	370	378

## DURASTAK

Product No	Description	Zone 1	Zone 2	Zone 3	Zone 4
9313680	JR. LOFT BED, TWIN XL	1556	1595	1634	1673
9313675	JR. LOFT BED, TWIN	1527	1565	1603	1642
9310080	LOFTING KIT, TWIN XL	1287	1319	1351	1384
9310075	LOFTING KIT, TWIN	1258	1289	1321	1352
9315480	JR. LOFT BED, FULL XL	1890	1937	1984	2032
9315475	JR. LOFT BED, FULL	1858	1904	1951	1997
9313600	JR. LOFT BED END, TWIN	643	659	675	691
9315400	JR. LOFT BED END, FULL	784	804	823	843

## FORGE

Product No	Description	Zone 1	Zone 2	Zone 3	Zone 4
9315297	JR LOFT BED, TWIN XL INCLUDES 2 ENDS, XL SPRING BASE	1185	1215	1244	1274
9315296	JR LOFT BED, TWIN, INCLUDES 2 ENDS, SPRING BASE	1233	1264	1295	1325
9315299	LOFTING KIT, TWIN XL, INCLUDES 2 ENDS, XL STABILIZER BAR	780	800	819	838
9315298	LOFTING KIT, TWIN, INCLUDES 2 ENDS, STABILIZER BAR	760	779	798	817
9315200	JR LOFT BED END, TWIN	389	399	408	418

## MASON

Product No	Description	Zone 1	Zone 2	Zone 3	Zone 4
9613821	MASON BED, TWIN, REGULAR	1,082	1,109	1,136	1,163
9613822	MASON BED, TWIN, XL	1,184	1,214	1,243	1,273
9615421	MASON BED, FULL, REGULAR	1,229	1,260	1,291	1,321
9615422	MASON BED, FULL, XL	1,357	1,391	1,424	1,458
9613820	MASON HEADBOARD, TWIN	500	513	525	538
9615420	MASON HEADBOARD, FULL	650	666	683	699
9613829	MASON FOOTBOARD, TWIN	400	410	420	430
9615429	MASON FOOTBOARD, FULL	500	513	525	538

## MASON OPTIONS

Product No	Description	Zone 1	Zone 2	Zone 3	Zone 4
-	TWIN SPRINGBASE UPCHARGE	225	231	236	242
-	FULL SPRINGBASE UPCHARGE	350	359	368	376
-	TWIN HEADBOARD UPCHARGE	150	154	158	161
-	FULL HEADBOARD UPCHARGE	250	256	263	269

# BEDS

## TRUSTAK

Product No	Description	Zone 1	Zone 2	Zone 3	Zone 4
9817101	JR LOFT, TWIN XL, INCLUDES 2 TWIN ENDS, XL SPRING BASE	1779	1823	1868	1912
9817100	JR LOFT, TWIN, INCLUDES 2 TWIN ENDS, SPRING BASE	1744	1788	1831	1875
9817104	LOFTING KIT, TWIN XL, INCLUDES 2 TWIN ENDS, XL STABILIZER BAR	1471	1508	1545	1581
9817103	LOFTING KIT, TWIN, INCLUDES 2 TWIN ENDS, STABILIZER BAR	1437	1473	1509	1545
9817111	JR LOFT, FULL XL, INCLUDES 2 FULL ENDS, XL SPRING BASE	2100	2152	2205	2258
9817110	JR LOFT, FULL, INCLUDES 2 FULL ENDS, SPRING BASE	2066	2118	2169	2221
9817105	BED END, TWIN (SINGLE END)	734	752	771	789
9817115	BED END, FULL (SINGLE END)	872	894	916	937
9618037	SPRING BASE, FULL XL, ADJUSTABLE HOOK-IN, 54"X80"	734	752	771	789
9618036	SPRING BASE, FULL, ADJUSTABLE HOOK-IN, 54"X75"	689	706	723	741

## ZTRAK

Product No	Description	Zone 1	Zone 2	Zone 3	Zone 4
9717002	JR LOFT BED, TWIN XL, INCLUDES 2 ENDS, XL SPRING BASE, XL STABILIZER BAR	2095	2147	2200	2252
9717001	JR LOFT BED, TWIN INCLUDES 2 ENDS, SPRING BASE, STABILIZER BAR	2039	2090	2141	2192
9717004	LOFT BED, TWIN XL, INCLUDES 2 ENDS, XL SPRING BASE, XL STABILIZER BAR	2501	2564	2626	2689
9717003	LOFT BED, TWIN INCLUDES 2 ENDS, SPRING BASE, STABILIZER BAR	2446	2507	2568	2629
9717006	BUNK BED, TWIN XL, INCLUDES 2 ENDS, 2 XL SPRING BASES	2852	2923	2995	3066
9717005	BUNK BED, TWIN INCLUDES 2 ENDS, 2 SPRING BASES	2747	2816	2884	2953
9717202	JR LOFT BED, FULL XL, INCLUDES 2 ENDS, XL SPRING BASE, XL STABILIZER BAR	2295	2352	2410	2467
9717201	JR LOFT BED, FULL, INCLUDES 2 ENDS, SPRING BASE, STABILIZER BAR	2238	2294	2350	2406
9717204	LOFT BED, FULL XL, INCLUDES 2 ENDS, XL SPRING BASE, XL STABILIZER BAR	2982	3057	3131	3206
9717203	LOFT BED, FULL, INCLUDES 2 ENDS, SPRING BASE, STABILIZER BAR	2926	2999	3072	3145
9717206	BUNK BED, FULL XL, INCLUDES 2 ENDS, 2 XL SPRING BASES	4016	4116	4217	4317
9717205	BUNK BED, FULL, INCLUDES 2 ENDS, 2 SPRING BASES	3959	4058	4157	4256

## ZTRAK W/ZLOK

Product No	Description	Zone 1	Zone 2	Zone 3	Zone 4
9717008	JR LOFT BED WITH ZLOK, TWIN XL, INCLUDES 2 ENDS, XL ZLOK SPRING BASE, XL ZLOK STABILIZER BAR	2815	2885	2956	3026
9717007	JR LOFT BED WITH ZLOK, TWIN, INCLUDES 2 ENDS ZLOK SPRING BASE, ZLOK STABILIZER BAR	2767	2836	2905	2975
9717010	LOFT BED WITH ZLOK, TWIN XL, INCLUDES 2 ENDS XL ZLOK SPRING BASE, XL ZLOK STABILIZER BAR	3334	3417	3501	3584
9717009	LOFT BED WITH ZLOK, TWIN, INCLUDES 2 ENDS, ZLOK SPRING BASE, ZLOK STABILIZER BAR	3285	3367	3449	3531
9717012	BUNK BED WITH ZLOK, TWIN XL INCLUDES 2 ENDS, 2 XL ZLOK SPRING BASES	3899	3996	4094	4191
9717011	BUNK BED WITH ZLOK, TWIN, INCLUDES 2 ENDS, 2 ZLOK SPRING BASES	3790	3885	3980	4074
9717208	JR LOFT BED WITH ZLOK, FULL XL, INCLUDES 2 ENDS, XL ZLOK SPRING BASE, XL ZLOK STABILIZER BAR	2982	3057	3131	3206
9717207	JR LOFT BED WITH ZLOK, FULL, INCLUDES 2 ENDS, ZLOK SPRING BASE, ZLOK STABILIZER BAR	2926	2999	3072	3145
9717210	LOFT BED W/ZLOK, FULL XL, INCLUDES 2 ENDS, XL ZLOK SPRING BASE, XL ZLOK STABILIZER BAR	3671	3763	3855	3946
9717209	LOFT BED WITH ZLOK, FULL, INCLUDES 2 ENDS, ZLOK SPRING BASE, ZLOK STABILIZER BAR	3614	3704	3795	3885
9717212	BUNK BED WITH ZLOK, FULL XL, INCLUDES 2 ENDS, 2 XL ZLOK SPRING BASES	4703	4821	4938	5056
9717211	BUNK BED WITH ZLOK, FULL, INCLUDES 2 ENDS, 2 ZLOK SPRING BASES	4647	4763	4879	4996

## ZTRAK BED SYSTEM COMPONENTS

Product No	Description	Zone 1	Zone 2	Zone 3	Zone 4
9717013	LADDER END FOR TWIN JR LOFT - SINGLE END	869	891	912	934
9717014	LADDER END FOR TWIN LOFT OR BUNK, SINGLE END	1120	1148	1176	1204
9717213	LADDER END FOR FULL JR LOFT - SINGLE END	862	884	905	927
9717214	LADDER END FOR FULL LOFT OR BUNK - SINGLE BED	1119	1147	1175	1203

# BEDS

## ZTRAK BED SYSTEM COMPONENTS

Product No	Description	Zone 1	Zone 2	Zone 3	Zone 4
9717016	ZLOK SPRING BASE, TWIN XL	960	984	1008	1032
9717015	ZLOK SPRING BASE, TWIN	926	949	972	995
9717215	ZLOK SPRING BASE, FULL	1101	1129	1156	1184
9717216	ZLOK SPRING BASE, FULL XL	1136	1164	1193	1221
9717018	ZLOK STABILIZER BAR, XL, METAL	349	358	366	375
9717017	ZLOK STABILIZER BAR, METAL	345	354	362	371
9725519	RAIL-MOUNTED DESK (WOOD LADDER ENDS ONLY)	972	996	1021	1045

## ZTRAK OPTIONS

Product No	Description	Zones 1-4			
-	EXTRA PLATES (ADDS 2 FOR A TOTAL OF 5 PER END)	352			

## UNIVERSAL BED ACCESSORIES

Product No	Description	Zone 1	Zone 2	Zone 3	Zone 4
9315294	LADDER, METAL	240	246	252	258
9613745	GUARDRAIL, METAL	236	242	248	254
9613746	GUARDRAIL, WOOD PANEL	337	345	354	362
9615522	SIDE TABLE BED ACCESSORY	328	336	344	353
9619065	DOUBLE STABILIZER BAR, METAL	198	203	208	213
9619066	DOUBLE STABILIZER BAR, XL, METAL	227	233	238	244
9625520	RAIL-MOUNTED END SHELF	492	504	517	529
9625521	RAIL-MOUNTED END SHELF, DOUBLE	944	968	991	1015
9689220	MOBILE CHARGING STATION	118	121	124	127

## UNIVERSAL BED ACCESSORIES

Product No	Description	Zones 1-4			
710001	LASER CUT (311 SET UP CHARGE PER ORDER, AVAILABLE ON WOOD GUARDRAIL ONLY)	210			

## UNIVERSAL BOX SPRINGS, SPRING BASES, BED PLATFORMS

Product No	Description	Zone 1	Zone 2	Zone 3	Zone 4
9658011	TWIN XL XP PLUS BLUE NYLON WOOD FOUNDATION	592	607	622	636
9658010	TWIN XP PLUS BLUE NYLON WOOD FOUNDATION	592	607	622	636
9658012	WOOD FOUNDATION, NYLON, FULL	592	607	622	636
9618027	SPRING BASE, TWIN XL, ADJUSTABLE HOOK-IN, 36"X 80"	482	494	506	518
9618026	SPRING BASE, TWIN, ADJUSTABLE HOOK-IN, 36"X75"	449	460	471	483
9618062	SPRING BASE, TWIN XL, ADJUSTABLE HOOK-IN 38" X 80"	653	669	686	702
9618061	SPRING BASE, TWIN, ADJUSTABLE HOOK-IN, 38" X 75"	616	631	647	662
9616603	SEALED BED PLATFORM, TWIN XL, 38"X 79	365	374	383	392
9616608	TWIN 37 1/4 X 74 SEALED BED PLATFORM	327	335	343	352
9612501	BED PLATFORM, FULL, SEALED	400	410	420	430
9618001	STRONG ARM SUPPORT WITH CENTER SUPPORT LEG, 3 PIECE, ADJUSTS FROM FULL TO KING	145	149	152	156

## UNIVERSAL MATTRESSES

Product No	Description	Zone 1	Zone 2	Zone 3	Zone 4
9656688	MATTRESS, DUAL FIRM INNERSPRING, TWIN XL W/BLUE NYL TCKNG, INV SEAM, TB129 BOS IX-1	805	825	845	865
9656687	MATTRESS, DUAL FIRM INNERSPRING, TWIN, 36"X75" W/BLUE NYL TCKNG, INV SEAM, TB129 BOS IX-1	791	811	831	850
9656685	MATTRESS, DUAL FIRMING INNERSPRING, TWIN XL 38"X80" W/BLUE NYL TCKNG, INV SEAM, TB129. BOX IX-2	889	911	933	956

# BEDS

UNIVERSAL MATTRESSES					
Product No	Description	Zone 1	Zone 2	Zone 3	Zone 4
9656684	MATTRESS, DUAL FIRM INNERSPRING, TWIN, 38" X 75" W/BBLUE NYL TCKING, INV SEAM, TB129, BOS IX-1	905	928	950	973
9656686	MATTRESS, DUAL-FIRM INNERSPRING, FULL	1307	1340	1372	1405
9656605	MATTRESS, DUAL FIRM ALL FOAM, TWIN XL, 36" X 80"	782	802	821	841
9656604	MATTRESS, DUAL FIRM ALL FOAM, TWIN, 36" X 75"	763	782	801	820
9656607	MATTRESS, DUAL FIRM ALL FOAM, TWIN XL, 38" X 80"	838	859	880	901
9656606	MATTRESS, DUAL FIRM ALL FOAM, TWIN 38" X 75"	817	837	858	878
9656608	MATTRESS, DUAL FIRM ALL FOAM, FULL 53" X 75"	1274	1306	1338	1370
9656689	MATTRESS, DUAL FIRM INNERSPRING, FULL XL 53"X80" W/BBLUE NYL TCKNG, INV SEAM, TB129 BOX IX-1	1307	1340	1372	1405

# CASEGOODS, DESKS & STORAGE

## ENDURE DESKS

Product No	Description	Zone 1	Zone 2	Zone 3	Zone 4
9920027	DESK, WRITING, SECURE DRAWER, 27"W	1049	1075	1101	1128
9920030	DESK, WRITING, SECURE DRAWER, 30"W	1071	1098	1125	1151
9920033	DESK, WRITING, SECURE DRAWER, 33"W	1092	1119	1147	1174
9920036	DESK, WRITING, SECURE DRAWER, 36"W	1115	1143	1171	1199
9920039	DESK, WRITING, SECURE DRAWER, 39"W	1136	1164	1193	1221
9920042	DESK, WRITING, SECURE DRAWER, 42"W	1159	1188	1217	1246
9922042	DESK, PEDESTAL, DRAWER & DOOR, PENCIL DRAWER	1865	1912	1958	2005
9922142	DESK, PEDESTAL, DRAWER & CUBBY, PENCIL DRAWER	1809	1854	1899	1945
9921042	DESK, PEDESTAL, DRAWER & DOOR	1777	1821	1866	1910
9921142	DESK, PEDESTAL, DRAWER & CUBBY	1721	1764	1807	1850

## ENDURE STORAGE

Product No	Description	Zone 1	Zone 2	Zone 3	Zone 4
9932024	CHEST, 2-DRAWER, 24"W	1201	1231	1261	1291
9932027	CHEST, 2-DRAWER, 27"W	1245	1276	1307	1338
9932030	CHEST, 2-DRAWER, 30"W	1289	1321	1353	1386
9932033	CHEST, 2-DRAWER, 33"W	1333	1366	1400	1433
9932036	CHEST, 2-DRAWER, 36"W	1377	1411	1446	1480
9933024	CHEST, 3-DRAWER, 24"W	1642	1683	1724	1765
9933027	CHEST, 3-DRAWER, 27"W	1686	1728	1770	1812
9933030	CHEST, 3-DRAWER, 30"W	1730	1773	1816	1860
9933033	CHEST, 3-DRAWER, 33"W	1775	1819	1864	1908
9933036	CHEST, 3-DRAWER, 36"W	1819	1864	1910	1955
9934024	CHEST, 4-DRAWER, 24"W	2018	2068	2119	2169
9934027	CHEST, 4-DRAWER, 27"W	2061	2113	2164	2216
9934030	CHEST, 4-DRAWER, 30"W	2105	2158	2210	2263
9934033	CHEST, 4-DRAWER, 33"W	2149	2203	2256	2310
9934036	CHEST, 4-DRAWER, 36"W	2194	2249	2304	2359
9935024	CHEST, 5-DRAWER, 24"W	2348	2407	2465	2524
9935027	CHEST, 5-DRAWER, 27"W	2392	2452	2512	2571
9935030	CHEST, 5-DRAWER, 30"W	2437	2498	2559	2620
9935033	CHEST, 5-DRAWER, 33"W	2481	2543	2605	2667
9935036	CHEST, 5-DRAWER, 36"W	2525	2588	2651	2714
9940118	WARDROBE, 18"W, 52"H	1905	1953	2000	2048
9940124	WARDROBE, 24"W, 52"H	2127	2180	2233	2287
9940136	WARDROBE, 36"W, 52"H	2347	2406	2464	2523
9940218	WARDROBE, 18"W, 62"H	2060	2112	2163	2214
9940224	WARDROBE, 24"W, 62"H	2281	2338	2395	2452
9940236	WARDROBE, 36"W, 62"H	2501	2564	2626	2689
9940318	WARDROBE, 18"W, 72"H	2214	2269	2325	2380
9940324	WARDROBE, 24"W, 72"H	2436	2497	2558	2619
9940336	WARDROBE, 36"W, 72"H	2656	2722	2789	2855
9941218	WARDROBE, 1-DRAWER, 18"W, 62"H	2214	2269	2325	2380
9941224	WARDROBE, 1-DRAWER, 24"W, 62"H	2436	2497	2558	2619
9941236	WARDROBE, 1-DRAWER, 36"W, 62"H	2656	2722	2789	2855
9941318	WARDROBE, 1-DRAWER, 18"W, 72"H	2369	2428	2487	2547
9941324	WARDROBE, 1-DRAWER, 24"W, 72"H	2590	2655	2720	2784

# CASEGOODS, DESKS & STORAGE

## ENDURE STORAGE

Product No	Description	Zone 1	Zone 2	Zone 3	Zone 4
9941336	WARDROBE, 1-DRAWER, 36"W, 72"H	2810	2880	2950	3021
9942318	WARDROBE, 2-DRAWER, 18"W, 72"H	2523	2586	2649	2712
9942324	WARDROBE, 2-DRAWER, 24"W, 72"H	2744	2813	2881	2950
9942336	WARDROBE, 2-DRAWER, 36"W, 72"H	2965	3039	3113	3187
9932001	PEDESTAL, ROLLING, 2-DRAWER	1049	1075	1101	1128
9931002	PEDESTAL, ROLLING, DRAWER & DOOR	1081	1108	1135	1162
9932011	NIGHTSTAND, 2-DRAWER	1049	1075	1101	1128
9931012	NIGHTSTAND, DRAWER & DOOR	1081	1108	1135	1162
9931004	NIGHTSTAND, DRAWER & CUBBY	1026	1052	1077	1103

## MERIT DESKS

Product No	Description	Zone 1	Zone 2	Zone 3	Zone 4
9820027	DESK, WRITING, 27"W	579	593	608	622
9820030	DESK, WRITING, 30"W	605	620	635	650
9820033	DESK, WRITING, 33"W	631	647	663	678
9820036	DESK, WRITING, 36"W	658	674	691	707
9820039	DESK, WRITING, 39"W	684	701	718	735
9820042	DESK, WRITING, 42"W	710	728	746	763
9821042	DESK, PEDESTAL, DRAWER & DOOR	1269	1301	1332	1364
9821142	DESK, PEDESTAL, DRAWER & CUBBY	1229	1260	1290	1321
9821242	DESK, PEDESTAL, 2-DRAWER	1368	1402	1436	1471
9821342	DESK, PEDESTAL, 3-DRAWER	1473	1510	1547	1583
9822042	DESK, PEDESTAL, DRAWER & DOOR, METAL LEG	1290	1322	1354	1387
9822142	DESK, PEDESTAL, DRAWER & CUBBY, METAL LEG	1251	1282	1314	1345
9825230	DESK, WRITING DESK WITH METAL LEGS, 42"W	791	811	831	850
9825231	DESK, WRITING DESK WITH METAL LEGS, SECURE DRAWER, 42"W	1083	1110	1137	1164
9825244	DESK, WRITING WITH METAL LEGS, 30"W	772	791	811	830
9825245	DESK, WRITING WITH METAL LEGS, SECURE DRAWER, 30"W	1063	1090	1116	1143
9822242	DESK, PEDESTAL, 2-DRAWER, METAL LEG	1389	1424	1458	1493
9822342	DESK, PEDESTAL, 3-DRAWER, METAL LEG	1494	1531	1569	1606

## MERIT DESK OPTIONS

Product No	Description	Zones 1-4
-	DESK PENCIL DRAWER	238
-	PENCIL DRAWER EYEHOOK	32

## MERIT STORAGE

Product No	Description	Zone 1	Zone 2	Zone 3	Zone 4
9832024	CHEST, 2-DRAWER, 24"W	859	880	902	923
9832027	CHEST, 2-DRAWER, 27"W	911	934	957	979
9832030	CHEST, 2-DRAWER, 30"W	964	988	1012	1036
9832033	CHEST, 2-DRAWER, 33"W	1016	1041	1067	1092
9832036	CHEST, 2-DRAWER, 36"W	1069	1096	1122	1149
9833024	CHEST, 3-DRAWER, 24"W	1361	1395	1429	1463
9833027	CHEST, 3-DRAWER, 27"W	1429	1465	1500	1536
9833030	CHEST, 3-DRAWER, 30"W	1497	1534	1572	1609

# CASEGOODS, DESKS & STORAGE

## MERIT STORAGE

Product No	Description	Zone 1	Zone 2	Zone 3	Zone 4
9833033	CHEST, 3-DRAWER, 33"W	1566	1605	1644	1683
9833036	CHEST, 3-DRAWER, 36"W	1634	1675	1716	1757
9834024	CHEST, 4-DRAWER, 24"W	1691	1733	1776	1818
9834027	CHEST, 4-DRAWER, 27"W	1765	1809	1853	1897
9834030	CHEST, 4-DRAWER, 30"W	1839	1885	1931	1977
9834033	CHEST, 4-DRAWER, 33"W	1913	1961	2009	2056
9834036	CHEST, 4-DRAWER, 36"W	1986	2036	2085	2135
9835024	CHEST, 5-DRAWER, 24"W	2023	2074	2124	2175
9835027	CHEST, 5-DRAWER, 27"W	2101	2154	2206	2259
9835030	CHEST, 5-DRAWER, 30"W	2180	2234	2289	2344
9835033	CHEST, 5-DRAWER, 33"W	2259	2315	2372	2428
9835036	CHEST, 5-DRAWER, 36"W	2338	2396	2455	2513
9840118	WARDROBE, 18"W, 52"H	1180	1210	1239	1268
9840124	WARDROBE, 24"W, 52"H	1364	1398	1432	1466
9840136	WARDROBE, 36"W, 52"H	1547	1586	1624	1663
9840218	WARDROBE, 18"W, 62"H	1259	1290	1322	1353
9840224	WARDROBE, 24"W, 62"H	1442	1478	1514	1550
9840236	WARDROBE, 36"W, 62"H	1626	1667	1707	1748
9840318	WARDROBE, 18"W, 72"H	1337	1370	1404	1437
9840324	WARDROBE, 24"W, 72"H	1521	1559	1597	1635
9840336	WARDROBE, 36"W, 72"H	1705	1748	1790	1833
9841218	WARDROBE, 1-DRAWER, 18"W, 62"H	1600	1640	1680	1720
9841224	WARDROBE, 1-DRAWER, 24"W, 62"H	1784	1829	1873	1918
9841236	WARDROBE, 1-DRAWER, 36"W, 62"H	1968	2017	2066	2116
9841318	WARDROBE, 1-DRAWER, 18"W, 72"H	1679	1721	1763	1805
9841324	WARDROBE, 1-DRAWER, 24"W, 72"H	1863	1910	1956	2003
9841336	WARDROBE, 1-DRAWER, 36"W, 72"H	2046	2097	2148	2199
9842318	WARDROBE, 2-DRAWER, 18"W, 72"H	2021	2072	2122	2173
9842324	WARDROBE, 2-DRAWER, 24"W, 72"H	2204	2259	2314	2369
9842336	WARDROBE, 2-DRAWER, 36"W, 72"H	2388	2448	2507	2567
9832001	PEDESTAL, ROLLING, 2-DRAWER	749	768	786	805
9831002	PEDESTAL, ROLLING, DRAWER & DOOR	772	791	811	830
9831031	PEDESTAL, ROLLING, HIGH, DRAWER & CUBBY, 30"H	962	986	1010	1034
9832011	NIGHTSTAND, 2-DRAWER	749	768	786	805
9831012	NIGHTSTAND, DRAWER & DOOR	772	791	811	830
9831004	NIGHTSTAND, DRAWER & CUBBY	733	751	770	788
9885260	BOOKCASE, 2-SHELF	502	515	527	540

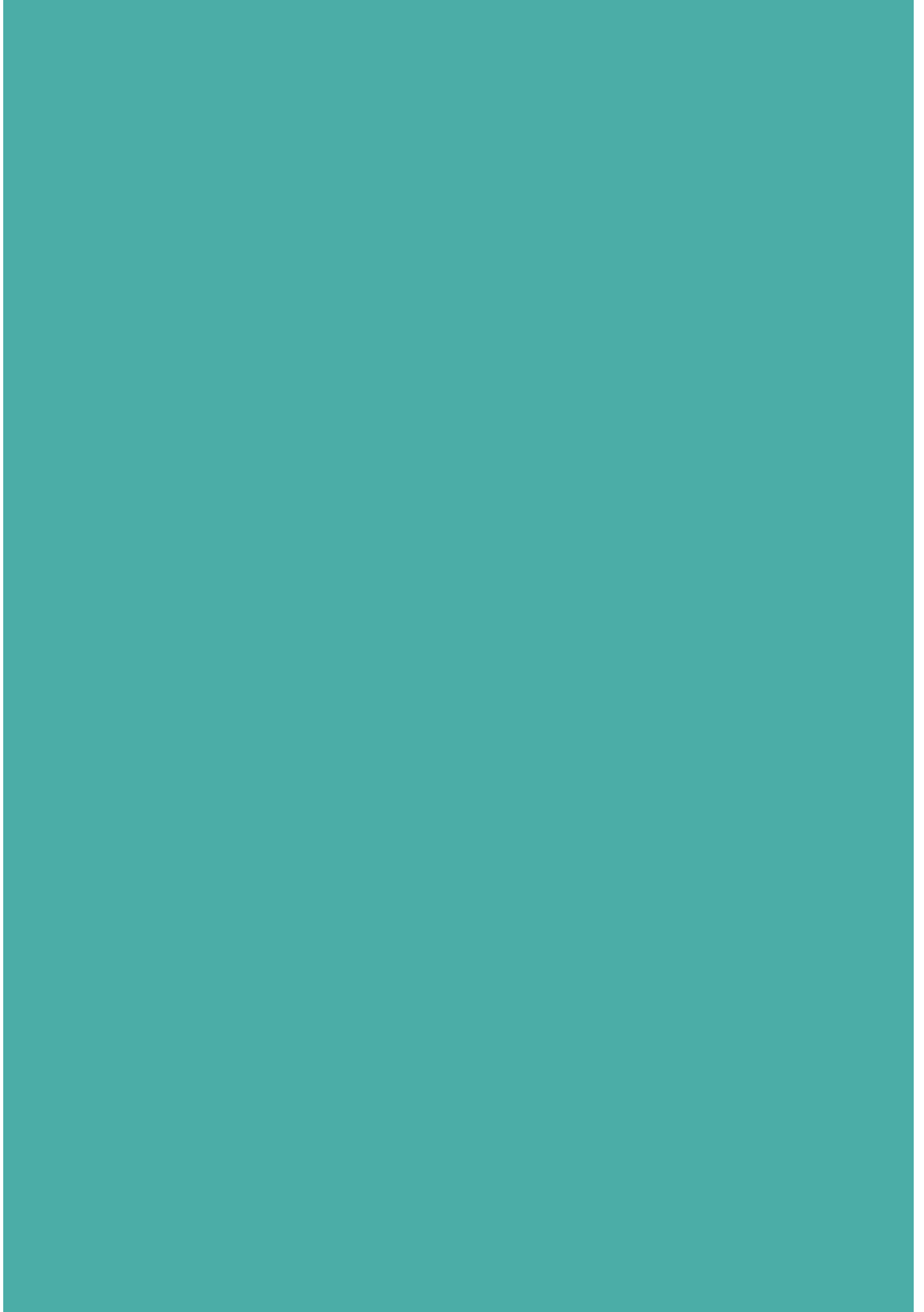

Sauder Education  
201 Horton Street  
Stryker, OH 43557

800.537.1530  
saudereducation.com

© 2025 Sauder Manufacturing Co. FOR INTERNAL USE ONLY.

Sauder Education believes the information in this price book to be correct at the time of printing. However, pricing, specifications, standard equipment, options, finishes and colors are subject to change without notice.

"Sauder" is a registered trademark of Sauder Woodworking Corporation.  
"Trey" and "Sauder Education" are registered trademarks of Sauder Manufacturing Co.

Contract

# Price List

**Butler Human Services® Furniture**

Effective October 1, 2025



## GENERAL INFORMATION

---

TERMS AND CONDITIONS .....	3-6
WARRANTY AND RENEWABILITY .....	7

## LIVING ROOM

---

ALLURE .....	8
BRIDGE .....	8
CANTON .....	8
CANYON .....	8
CAVETTO .....	8
CAVETTO OPTIONS .....	8-9
CHILL .....	9
CHILL OPTIONS .....	9
MOMENT .....	9
RALLY .....	9-10
RALLY OPTIONS .....	10
RIO .....	11
4000 SERIES RECLINERS .....	11

## WOOD SEATING

---

CLASSIC .....	12
MISSION .....	12
CLASSIC/MISSION CUSHION REPLACEMENT .....	12
CLASSIC MISSION FOAM .....	12
LEGACY .....	12
LEGACY REPLACEMENT FOAM .....	13
LEGACY ACCESSORIES .....	13

## OCCASIONAL AND DINING TABLES

---

ALLY OCCASIONAL .....	14
ATWOOD .....	14
CANTON .....	14
CLASSIC .....	14
DANBURY .....	14
DRUM AND CUBE .....	14-15
DRUM AND CUBE OPTIONS .....	15
LEGACY .....	15
MISSION .....	15
ROWAN .....	15
TRUMPET & DISC OCCASIONAL .....	16
ALLY MULTI-PURPOSE .....	16
ALLY MULTI-PURPOSE OPTIONS .....	17
CAFÉ .....	17
CLASSIC LEG .....	17
CLASSIC TRESTLE .....	17
KEATON TRESTLE .....	17
ROWAN METAL DINING .....	17
TAPERED LEG .....	17
TRUMPET & DISC .....	18
TUBULAR .....	18-20
TUBULAR OPTIONS .....	20
BISTRO .....	21

## DINING CHAIRS

---

BOWEN .....	21
CHANDLER .....	21
CLASSIC .....	21
DALTON .....	22
METAL STACK .....	22
PLYLOK .....	22
PLYLOK OPTIONS .....	22
PLYWEDGE .....	22
PLYWEDGE OPTIONS .....	22
UPLAND .....	22-23
UPLAND OPTIONS .....	23-24
WEDGEWOOD .....	24

## BEDROOM AND STORAGE

---

CAMDEN BEDS .....	25
CLASSIC BEDS .....	25
CLASSIC STORAGE .....	25
DURASTAK .....	26
ENDURE STORAGE .....	26
FORGE BEDS .....	26
FUSION BEDS .....	27
FUSION BED OPTIONS .....	27
LENOX BEDS .....	27
LENOX BED OPTIONS .....	27
MASON BEDS .....	27
MASON BED OPTIONS .....	28
LEGACY BEDS .....	28
LEGACY STORAGE .....	28
MERIT STORAGE .....	28-29
MERIT DESK OPTIONS .....	29
UNIVERSAL BED ACCESSORIES .....	29
MATTRESSES AND FOUNDATIONS .....	29
MATTRESS AND BOX SPRING ENCASUREMENTS .....	29
BED PLATFORMS AND SPRING BASES .....	29-30

## BEHAVIORAL HEALTH

---

CALVIN HD .....	31
COOPER DWIGHT HD .....	31
COOPER DWIGHT HD OPTIONS .....	31
DINING HD .....	31
DINING HD OPTIONS .....	31
DRUM, CUBE & OVAL HD .....	31
HARDI HD .....	32
HARDI HD OPTIONS .....	32
TAILOR HD .....	32
TAILOR HD OPTIONS .....	32
TRUMPET HD .....	33
1000 SERIES HD .....	33
1000 SERIES HD OPTIONS .....	33

# TERMS AND CONDITIONS

## CONTACT INFORMATION

Please contact Butler Human Services® Furniture with questions or for assistance.

Butler Human Services Furniture  
413-A Branchway Road  
N. Chesterfield, VA 23236  
Phone 877.852.0784 | Fax 804.897.0053  
butlerhumanservices.com | sales@butlerhumanservices.com

Butler Human Services Furniture is a brand of Sauder® Manufacturing Co.

## DEFINITIONS

Company means Sauder® Manufacturing Co., its servants, employees, and agents and includes Sauder® Manufacturing Co; Sauder Worship Seating®, Sauder Education®, Sauder® Courtroom Furniture; Wieland; Butler Human Services®, Sauder® Courtroom Seating; and any affiliated, predecessor or successor entities.

## GENERAL TERMS

### EXCLUSIVE CONTRACT TERMS

These Terms and Conditions shall be deemed incorporated as a part of every contract to purchase goods from the Company. By entering into a purchase contract with the Company and accepting delivery of the goods, Purchaser agrees that these Terms and Conditions are the sole and exclusive statement of all such terms and conditions, that the contract is limited to these terms and conditions, and that any different or additional terms and conditions proposed by Purchaser are objected to and shall not become a part of the contract unless expressly accepted by Company in writing.

### AUTHORIZED DEALERS

Possession of these terms and conditions, product information and/or price list does not imply the right to purchase products illustrated and priced therein. Sales are confined to accounts with credit approval only. A minimum of 30 percent down payment is required on all orders until credit is established.

### APPLICABLE LAW

The Contract shall be governed by the substantive laws of the State of Ohio. The sole and exclusive jurisdiction and venue for the enforcement of any rights or obligations relating to the contract or the goods shall be in the Fulton County, Ohio Court of Common Pleas or the United States District Court for the Northern District of Ohio, and the parties consent to the jurisdiction of these courts as a part of this transaction. The Company shall be entitled to recover its reasonable attorney's fees, costs and expenses in connection with any action taken by Company to enforce the contract (including these Terms and Conditions).

### GOVERNMENT REGULATIONS

Customer shall comply with all applicable governmental laws, codes, and regulations, including building and fire codes applicable to this purchase and including design, type of material and installation arrangements thereof.

## PRICES & PAYMENT TERMS

### PRICES

Published prices are list, FOB destination, per zone destination. Prices do not account for special delivery situations including the following, which are the responsibility of the Purchaser:

- Dedicated delivery appointments
- Lift gate
- Multiple drops on site per shipment
- Multiple shipments per order (that could be accommodated by one delivery)
- Charges for cartons, packaging, and crating, beyond the normal Company shipping methods

- Storage or insurance claims
- Sales and other taxes
- Local delivery, uncrating, and installation (if applicable)

Prices on Order Acknowledgments are net. Company reserves the right to change prices prior to Order Acknowledgment without notice. Company reserves the right to increase prices or any part thereof, if Purchaser delays delivery of the furniture beyond 8 weeks from receipt of any of the following: Order Acknowledgment, signed order contract, receipt of subcontract, and/or receipt of signed purchase order.

In addition to any other right of Company to increase prices as set forth herein, in the event Purchaser, for any reason, directs delivery of goods and services ordered to occur beyond 8 weeks from receipt of any of the following: Order Acknowledgment, signed order contract, receipt of subcontract, and/or receipt of signed purchase order, Purchaser shall bear the risk of and be responsible to pay Company any price increases that may occur in connection with the goods and services ordered as well as storage costs arising from or incurred as a result of same. Company reserves the right to require a non-refundable deposit be paid by Purchaser to Company in the event of the foregoing.

### PERFORMANCE BONDS

If a bond is required, the cost shall be 1% of the total Contract. If a bond is not specifically listed on the Contract it is not included. If a bond is purchased, the bond will only cover substantial completion of the project plus one year of the warranty period.

### TAXES

All sales are subject to sales tax unless a valid sales tax exemption certificate or resale certificate for the ship-to state accompanies the order.

### INVOICING

Product will be invoiced at the time of shipment, or as designated by the Order Acknowledgment. If a partial order is shipped and a back order is created, Purchaser will be invoiced for the portion that shipped.

### TERMS OF PAYMENT, SECURITY INTEREST AND LIEN RIGHTS

Credit will be established based upon Company's determination of credit worthiness. A deposit or prepayment may be required on certain accounts after credit review. Credit terms are 30 days net from date of invoice and/or as designated by the Order Acknowledgment. Company may cancel or change credit terms at its discretion and may request advance payment at any time. No order will be released for production without a credit approval from the Credit Department. Company may at its option, and without notice, raise or allow charges in excess of any credit limit granted. Purchaser understands and agrees that (the Purchaser) is responsible for all charges on the account. All payments due to Company shall be paid without any set-off or claim.

Purchaser agrees to pay a service charge of 1.5 percent per month or as allowed by law on all past due accounts. A past due account is an account that remains unpaid for more than 30 days. Until such time that an account and/or an order is paid in full to the Company, Company shall retain a security interest in and lien on all materials, merchandise, furnishings, and/or goods manufactured, provided, delivered or otherwise on said account and/or order. Company reserves and may exercise any and all rights and remedies with respect to said materials, merchandise, furnishings, and/or goods against the Customer and/or any individual or entity in possession of or claiming an interest in said materials, merchandise, furnishings and/or goods, including but not limited to demanding assembly of the goods at the direction of Company, re-taking possession and selling and applying proceeds of any sale toward the account, and/or filing suit. All charges are payable according to these terms and conditions unless otherwise prearranged and agreed to in writing by Company.

Initials \_\_\_\_\_ Date \_\_\_\_\_

# TERMS AND CONDITIONS

## TITLE & RISK

Title to all goods shall pass from Company to Purchaser upon Company's receipt of payment in full under this Contract or any change thereof.

Risk of loss or damage to the goods becomes the responsibility of Purchaser upon delivery. Unless otherwise specified in writing, Company will determine the method of shipment and carrier. If products are shipped via Purchaser's choice of carrier, Company is not responsible for damage in shipment.

Purchaser will insure the goods against all insurable risks in the name of Purchaser and also in the name of Sauder Manufacturing Co. as the unpaid vendor for their full insurable value.

## ORDERING & LEAD TIME

### ORDERING

A signed purchase order or contract received via mail, fax or email is required before an order is processed. In addition, credit applications, credit references and/or advance payments may be required for newly established accounts. Orders are not scheduled in production, nor materials purchased, until all details are received.

### ORDER ACKNOWLEDGEMENT

Orders are binding upon receipt of the Order Acknowledgement. The Order Acknowledgement, which relates to the acceptance of the order/contract, is sent after the order/contract contemplates pricing changes, if any, delivery dates and/or estimated installation completion. Any and all modifications to the Order Acknowledgement must be reconfirmed and signed by Company.

Acceptance of the Order Acknowledgement shall be evidenced by signature(s) and/or Company commencing work on the project.

Any error or discrepancy on the Order Acknowledgement must be reported to Company in writing within 3 working days from the receipt of the Order Acknowledgement. Cashing a down payment check does not constitute acceptance.

### CHANGE ORDERS

The order as shown on the Order Acknowledgement can be modified only by a written communication or reconfirmation signed by Company and Purchaser.

Company may, at its discretion, accept reasonable change orders with the following conditions:

- The request for change must be submitted in writing and received before order specific parts have been purchased and/or the manufacturing process has begun.
- Changes may be subject to additional charges for material, labor, restocking, and administrative costs.
- Changes may result in an extended delivery date.

### CANCELLATIONS

Any deposit made with respect to the order is non-refundable. Company reserves the right to cancel any order, with notice to Purchaser, due to breach of obligation or contract. Additionally, if an order is cancelled after order specific materials have been purchased and/or production has started, Purchaser will be responsible for the cost associated with those materials or production. Any Customer's Own Material (COM) supplied will be returned "as-is". This applies to any fabric that has been cut, wood parts with a finish applied, and all laminates. A cancellation or restocking charge of 1/3 of the net sale is applicable on orders cancelled.

### LEAD TIME

Lead times will vary based on specifications chosen and available manufacturing capacity. Consult your authorized sales representative or the home office when placing your order to determine estimated ship date.

### CUSTOM PRODUCTS AND MATERIALS

All nonstandard designs and materials are subject to a surcharge; contact Company for approval and pricing. The use of nonstandard designs and/or materials may cause extended delivery times and reduced warranty coverage.

## CUSTOMER'S OWN MATERIAL (COM)

Please contact Company on all COM fabrics. A sample of the COM fabric is required to be submitted to Company for approval and yardage estimate prior to placing an order. The sample should be large enough to indicate a repeat if applicable.

Yardage requirements will be calculated based on a variety of factors including roll width, pattern matching and direction. If a fabric is directional, it will be applied vertically unless specific instructions are given to the contrary. If a horizontal application is desired, please inform Company as additional yardage or special production techniques may be required. At Purchaser's request, Company may, in its discretion, for non-Company program fabrics handle the purchase of the COM fabric for a charge of 20 percent of the fabric list price.

Company reserves the right of preliminary approval for all COM prior to order acceptance. Even after such preliminary approval, Company reserves the right to reject COM if, upon physical inspection of the material, it proves unacceptable for use on Company products. When COM is accepted, Company assumes no responsibility for appearance, durability, color fastness, or any other quality after it is upholstered on a Company product.

Orders with COM are not scheduled into production until all materials are received and inspected. *Refer to the checklist to ensure the proper handling of COM fabrics.* If partial shipment entry is required, indicate on purchase order, or forward orders with standard products and COM products on separate purchase orders. Shipping address:

Sauder Manufacturing Co.  
C/O Butler Human Services Furniture  
10785 Rose Avenue  
New Haven, IN 46774-9246

## PRODUCT DESIGN, COMPLIANCE & SAFETY

### PRODUCT DESIGN

Company reserves the right to make changes in design and construction or discontinue products without prior notice.

### COMPLIANCE

Products offered by Company do comply with the requirements of local, state and national fire codes. The products offered as a base are manufactured with resilient filling materials and textiles in compliance with California Technical Bulletin TB117-2013.

However, any verification of compliance of COM materials with TB117-2013 is the responsibility of the person specifying the COM material.

### THE TOXIC SUBSTANCES CONTROL ACT

Enforced by the EPS, TSCA a law enacted in 1976 regulates chemical substances and mixtures in commerce. Products offered comply with all applicable rules or orders under the TSCA, and no chemical substances in violation of the TSCA are offered.

### GREENGUARD® CERTIFICATION

Company has achieved Greenguard certification on all products and Greenguard Gold on many. Please reference [butlerhumanservices.com](http://butlerhumanservices.com) for product specific information. GREENGUARD certified products are certified to meet GREENGUARD standards for low chemical emissions into indoor air during product usage. For more information, visit <https://spot.ulprospector.com/en/na/Builtenvironment> or contact Company for a complete list of all our certified products.



Initials \_\_\_\_\_ Date \_\_\_\_\_

# TERMS AND CONDITIONS

## BIFMA

Sauder Manufacturing Co. is proud to demonstrate a commitment to the environment, and to both the quality and performance of products through BIFMA e3 LEVEL testing and certification. Learn more about BIFMA Certification at [levelcertified.org](http://levelcertified.org).



## LEFT VS. RIGHT SPECIFICATIONS

Specify left- or right- when facing the front of the chair, unless otherwise specified.

## FREIGHT & DELIVERY

### FREIGHT

Unless otherwise arranged in writing, all Company shipments are made on a site-to-site basis (back of trailer). Unless otherwise specified in writing, we will determine the method of shipment and carrier. All weights and dimensions provided in product literature are approximate. See map below for zone identification within the continental United States. Contact your authorized sales representative for pricing in Alaska, Hawaii and outside the United States.

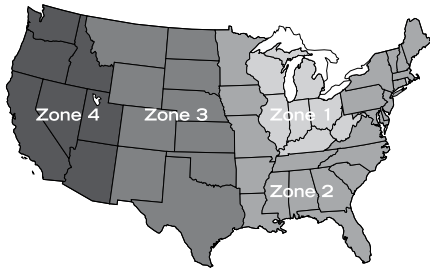

### MINIMUM SHIPPING AND HANDLING CHARGE

There will be a minimum delivery charge on all orders, regardless of size or number of products purchased.

### BUILDING ACCESS

Facilities must be ready to receive furniture. All construction must be complete before we can start delivery and installation. There must be free and clear easy access to the building where the furniture will be installed. Rooms, hallways, lobby, and entrance way must be empty and free and clear of all obstructions. All buildings with 3 or more floors must have working elevators free and clear of all obstructions and dedicated for the sole use of our installers during our installation. If upon arrival for delivery and installation, the conditions described in this paragraph are not met, the installation will not be started.

### DELAYED DELIVERY

Company reserves the right to increase prices or any part thereof, if Purchaser delays delivery of the furniture beyond 8 weeks from receipt of any of the following: Order Acknowledgment, signed order contract, receipt of subcontract, and/or receipt of signed purchase order. Purchaser agrees not to use the Goods described on the order until the full purchase price is paid to the Company.

In addition to any other right of Company to increase prices as set forth herein, in the event Purchaser, for any reason, directs delivery of goods and services ordered to occur beyond 8 weeks from receipt of any of the following: Order Acknowledgment, signed order contract, receipt of subcontract, and/or receipt of signed purchase order, Purchaser shall bear the risk of and be responsible to pay Company any price increases that may occur in connection with the goods and services ordered as well as storage costs arising from or incurred as a result of same. Company reserves the right to require a non-refundable deposit be paid by Purchaser to Company in the event of the foregoing.

### DELIVERY

Company shall not be liable for delays in delivery of furniture caused by fire, strikes, weather or from causes beyond its control.

An on-site delivery date will be established once all details needed for production and installation (if applicable) have been received. Delivery of Goods may be separate from commencement of installation.

The delivery price submitted is based on the understanding that there shall be appropriate access to the site free of any hindrance whatsoever, timely access to the site and adequate space to unload the Goods. In the event that the site is not fully ready as described previously at the time of delivery, Company reserves the right to charge and collect additional fees to cover any additional costs incurred. These charges include but not limited to the following: delivery appointment, consolidation of shipment, lift gate, multiple stops, special packaging, dedicated truck, expedited shipment, greater than two hour unload time, box truck required, residential shipment.

The goods may arrive in cardboard boxes. Unless otherwise specified, it is the Purchaser's responsibility to arrange for the disposal of the boxes.

### STORAGE FEES

If Goods are ready for shipment according to the terms of the Order Acknowledgment or subsequent change order, and Customer cannot receive as stated, the Goods may, at our discretion, be shipped to storage facilities, or put in storage at Purchaser's expense. Company reserves the right to deny storage of the Goods due to lack of available space. Storage fees are 5% of purchase price per month. These charges can, at Company's option, be added to the order total amount due or invoiced separately. Storage fees are considered change orders. See CHANGE ORDER SECTION requirements. All storage fees are required to be paid in full before ship. All risk of damage, destruction, theft or loss while in storage shall be the responsibility of Purchaser.

### INSIDE DELIVERY

Purchaser accepts responsibility for the safety of all persons except Company representatives on the premises where Company performs delivery and/or inside delivery and, accordingly, Purchaser shall also defend and save Company harmless from all claims from persons injured on the premises where delivery and/or installation is performed.

The inside delivery contract price is based upon full building and location access and readiness for installation to begin upon on-site delivery. The space must be climate controlled, not affect by outside weather conditions, permanent utilities must be operational and carpet and/or any flooring must be complete. In addition, any of the other contractors must not interfere with the unloading, staging or installation process including any overhead electrical, lighting or painting projects or any other work that would interfere with the placement of the furniture into its permanent locations. Failure to have the site ready for installation may result in additional cost to the Purchaser not previously shown on the contract. These additional costs may include, but are not limited to, additional handling charges, insurance, down-time (which includes additional labor, lodging and meals), and/or any other proper expense incurred by the Company. If site conditions cause a substantial delay, the mover may leave the job site, delivery will be rescheduled and Purchaser will be responsible for the return fee for the delivery crew.

### RETURNS & CLAIMS

#### RETURNS

If you are unhappy with your purchase and would like to start a return request, contact your Regional Sales Representative or Sales Support Team for authorization. No merchandise, including made-to-order fully upholstered items, modified or non-standard items, or mattresses that have been removed from their factory wrapping, may be returned to Company without prior written consent from Company, and any returns must be in accordance with Company's shipping instructions. If your request is approved, returns for reasons other than valid warranty claims will be subject to shipping and handling charges, and must be made, FOB the Company. In addition, restoration and restocking charges may be charged to Purchaser.

Initials \_\_\_\_\_ Date \_\_\_\_\_

# TERMS AND CONDITIONS

## DAMAGE CLAIMS

Freight terms are F.O.B. destination. Risk of loss, damage or destruction from and after delivery is the responsibility of Purchaser, it being agreed and understood that loss, damage or destruction of goods from and after delivery does not relieve Purchaser of its payment obligations to Company.

Purchaser is advised to inspect the shipment and note any damage on the bill of lading. Notification of damage discovered after delivery must be given to Company within 10 days immediately following delivery.

When products are shipped via Purchaser's choice of carrier, Company is not responsible for damage in shipment. Purchaser should carefully inspect all items at time of delivery and note any obvious damage on the delivery receipt. For Purchaser's protection, such obvious or subsequently discovered concealed damage must be reported in writing to the carrier in accordance with applicable regulations and time limits. Company does not assume any responsibility for damage that occurs during storage.

## OTHER CLAIMS

All claims against Company other than valid warranty claims, including claims for shortages and errors, must be made in writing within 10 days after delivery. The facts on which the claim is based must be directed in writing to the Warranty Service Coordinator. Failure to make any such claim against terms and conditions to Company within such 10-day period shall constitute acceptance of the merchandise and waiver of any such shortages, errors, or other claims of any type or nature. The cost of field repairs or adjustments performed by any non-Company personnel will not be reimbursed unless previously authorized in writing by Company.

## CONSEQUENTIAL LOSS

Under no circumstances shall Company be liable to any party hereto or any third-party for any special, indirect, punitive, incidental or consequential damages or loss (including lost profits, loss of use, damage to goodwill or loss of business) in connection with or in any way related to the agreement between the parties.

## FORCE MAJEURE AND OTHER MATTERS BEYOND COMPANY'S CONTROL

Company is not liable for failure to perform or delay in performance or delivery due to cancellation or postponement or deemed in breach of the Agreement (or PO if using Purchase Order) based on circumstances resulting from any cause beyond either parties control including, but not limited to, federal or state governmental orders or lack thereof, legislation, regulations, labor strikes, accidents, epidemic, pandemic, immediate threat of mass casualties or contagious illness or disease, act of war, riot, mass shooting, terrorism, acts of God, fires, severe weather conditions, floods, curtailment of transportation and or supply chain, inability to secure materials, electrical failure or any event that prohibits attendees being able to attend the event. Parties agree to minimize the damage of the Force Majeure Event to fullest extent possible. Notices shall state the nature of the Force Majeure Event, actions the party wishes to take, and if applicable a plan to mitigate any delays caused by the event. Such notice shall not subject either party to any penalties, liquidated damages, or forfeiture of any pre or post payment. Company reserves the right to modify order pricing and/or product offerings at any time based on material cost increases, supplier cost increases, economic fluctuations, supply chain issues and/or any other issues related to the foregoing. All orders may be subject to an increase in prices or any part thereof, and such other charges as set forth herein if Purchaser delays delivery of the furniture beyond 8 weeks from receipt of any of the following: Order Acknowledgment, signed order contract, receipt of subcontract, and/or receipt of signed purchase order.

Signature \_\_\_\_\_ Title \_\_\_\_\_ Date \_\_\_\_\_

# WARRANTY AND RENEWABILITY

## BUTLER HUMAN SERVICES® LIMITED WARRANTY

All products are warranted to the original purchaser against factory defects in workmanship and materials which first arise and are reported to the company within the applicable warranty periods.

Years under Warranty – Structure						
Seating	1	2	3	5	10	25
1000 Series HD						X
4000 Series Recliner*					X	
Allure						X
Bridge						X
Bistro					X	
Bowen					X	
Calvin HD						X
Canton						X
Canyon					X	
Cavetto						X
Chandler					X	
Chill					X	
Cooper Dwight HD						X
Dalton					X	
Hardi HD						X
HD Dining						X
Legacy					X	
Mission					X	
Moment						X
PlyLok						X
PlyWedge						X
Rally						X
Rio					X	
Tailor HD						X
Upland					X	
Wedgewood					X	
Years under Warranty – Structure						
Tables	1	2	3	5	10	25
Ally						X
Atwood					X	
Café Tables					X	
Canton						X
Danbury					X	
Disc Tables						X
Drum/Cube						X
Drum HD/Cube HD/Oval HD						X
Keaton					X	
Legacy					X	
Mission					X	
Rowen					X	
Tapered Leg Tables					X	
Trumpet						X
Tubular						X
Years under Warranty – Structure						
Bedroom Furniture	1	2	3	5	10	25
Blake					X	
Camden					X	
Endure						X
Fiero					X	
Fusion					X	
Hardi HD						X
HD Mattress						X
Lenox					X	
Mason					X	
Merit						X

Years under Warranty – Structure						
Bedroom Furniture	1	2	3	5	10	25
Spec Tex Mattresses	X					
XP Plus Mattresses		X				
Mattresses				X		
Spring Bases				X		
Fabric			X			

\*1-year warranty on working mechanisms.

### EXCLUSIONS

The following are specially excluded from the warranty:

1. Any custom components that are not a part of the company standard line. This would include, but not be limited to, custom-designed parts or customer specified components, such as fabric, vinyl, foam, etc., that are not a part of the standard company product line.
2. Accessories such as light bulbs that are considered consumables.
3. Furniture that has been unduly exposed to elements such as water, light radiation, etc.
4. Damage caused in storing/moving products or furniture after delivery and prior to installation – when stored at customer request.
5. Damage caused by on-site construction process, other contractors or subcontractors, or the work of such contractors or subcontractors, including drywall dust.
6. Damage as the result of accident, fire, flood, civil disorder, strike, Acts of God, abuse, misuse or any cause outside of ordinary usage.
7. Normal wear and tear, maintenance, scratching or natural wearing of finishes on chairs and tables.
8. Any responsibility for the effects the chairs have on flooring.
9. Damage caused from shipping.

### GENERAL INFORMATION

A. We have agreements with our upholstery suppliers to assure that all products meet Association of Contract Textiles standards for bow and skew. We also further eliminate pattern variability in our cutting process. However, you may still notice some irregularities that are within industry standards and are not covered under our product warranty.

B. Replacement, repair, or refund of the purchase price, (pro-rated for use), as determined by Company and is the "sole and exclusive" remedy under the warranty, and all incidental and consequential damages are excluded and disclaimed from warranty coverage.

C. To receive benefits under the terms of this warranty, the purchaser must:

1. Notify Company of the defect.
2. Fill out Company service request form, which will be sent to you, and provide a description of the defect.
3. Submit completed form along with applicable photos.

D. Any disputes over the provisions of this warranty will be mutually reviewed by representatives of Purchaser and Company.

E. All implied warranties, including any warranties of merchantability or fitness for a particular purpose are excluded and disclaimed. This Limited Warranty is the only warranty from COMPANY applicable to the goods.

This warranty information covers the structure of the furniture: the laminated-veneer or solid wood frame, the construction of the arms, table legs and stretchers, delamination of tables, and all fasteners and moving parts.

Butler Human Services warrants Butler Program Fabrics, if purchased through Butler Human Services for use on most Butler Human Service products for a period of 3 years. Fabrics that differ from the 3 year warranty will be marked accordingly.

# LIVING ROOM

## ALLURE

Product No	Description	COM Ydg	Moist. Barrier	Zone 1	Zone 2	Zone 3	Zone 4
58111	CHAIR	5.75 yd	Included	3652	3743	3835	3926
58112	LOVESEAT	7 yd	Included	6170	6324	6478	6633
58113	SOFA	9.25 yd	Included	7454	7640	7827	8013

## BRIDGE

Product No	Description	COM Ydg	Moist. Barrier	Zone 1	Zone 2	Zone 3	Zone 4
C30-1	AUBURN CHAIR	5.25 yd	Included	3319	3402	3485	3568
C30-2	AUBURN LOVESEAT	6.5 yd	Included	5621	5762	5902	6043
C30-3	AUBURN SOFA	10.25 yd	Included	6755	6924	7093	7262
C30-OT	AUBURN OTTOMAN	3.25 yd	Included	1210	1240	1270	1301
C01-1	GARRETT CHAIR	6.5 yd	Included	3223	3304	3384	3465
C01-2	GARRETT LOVESEAT	8 yd	Included	5432	5568	5704	5839
C01-3	GARRETT SOFA	9.75 yd	Included	6539	6702	6866	7029
C01-OT	GARRETT OTTOMAN	3.25 yd	Included	1202	1232	1262	1292

## CANTON

Product No	Description	COM Ydg	Moist. Barrier	Zone 1	Zone 2	Zone 3	Zone 4
67CN01M	CHAIR, METAL FRAME	1.75 yd	21	1758	1802	1846	1890
67CN02M	LOVESEAT, METAL FRAME	3.5 yd	42	2883	2955	3027	3099
67CN12M	LOVESEAT, METAL FRAME, SHORT CENTER ARMS	3.5 yd	42	3191	3271	3351	3430
67CN01L	LOVESEAT, METAL FRAME, CONTINUOUS SEAT	3.5 yd	42	2735	2803	2872	2940
67CN13M	SOFA, METAL FRAME, SHORT CENTER ARMS	5.25 yd	63	4474	4586	4698	4810
67CN03M	SOFA, METAL FRAME	5.25 yd	63	3906	4004	4101	4199
67CN01G	CHAIR, WIDE, METAL FRAME, BARIATRIC	3 yd	36	2223	2279	2334	2390
67CN01H	PATIENT CHAIR, METAL FRAME, HIGH BACK	2.5 yd	30	1956	2005	2054	2103
67CN01ME	EASY ACCESS CHAIR, METAL FRAME	1.75 yd	21	1927	1975	2023	2072

## CANYON

Product No	Description	COM Ydg	Moist. Barrier	Zone 1	Zone 2	Zone 3	Zone 4
7977260	CHAIR	5.75 yd	69	2342	2401	2459	2518
7977261	LOVESEAT	8.5 yd	102	3702	3795	3887	3980
7977262	SOFA	11 yd	132	4836	4957	5078	5199

## CAVETTO

Product No	Description	COM Ydg	Moist. Barrier	Zone 1	Zone 2	Zone 3	Zone 4
59111	CHAIR	5.25 yd	Included	4126	4229	4332	4435
59112	LOVESEAT	8 yd	Included	6999	7174	7349	7524
59113	SOFA	10.5 yd	Included	8460	8672	8883	9094

## CAVETTO OPTIONS

Product No	Description	Zones 1-4					
-	CAVETTO METAL LEG UPCHARGE	155					

Premium Fabric Grades	B	C	D	E	F	G	H	I	J	K	L
Multiply by COM Ydg	16	36	55	79	119	158	198	237	277	356	435

Available for an upcharge. List price per yard.

\*eQuote is available for live configuration pricing. Contact customer service or sales representative with questions.

# LIVING ROOM

## CAVETTO OPTIONS

Product No	Description	Zones 1-4
-	CAVETTO MOBILITY W/ WOOD LEGS	336
-	CAVETTO MOBILITY W/ METAL LEGS	406
-	CAVETTO TABLET ARMS, TL AND TR	958

## CHILL

Product No	Description	COM Ydg	Moist. Barrier	Zone 1	Zone 2	Zone 3	Zone 4
15311	CHAIR	4.75 yd	-	2725	2793	2861	2929
15312	LOVESEAT	6.25 yd	-	4135	4238	4342	4445
15313	SOFA	8.25 yd	-	5308	5441	5573	5706
15111	CHAIR WITH 1 UPH ARM	4.25 yd	-	2533	2596	2660	2723
15401	ARMLESS CHAIR	3.25 yd	-	2365	2424	2483	2542
15441	CORNER CHAIR	4.75 yd	-	3120	3198	3276	3354
15-OT	OTTOMAN, SQUARE	3.25 yd	-	2484	2546	2608	2670
15-OT-M	OTTOMAN, INLINE	2.75 yd	-	1958	2007	2056	2105

## CHILL OPTIONS

Product No	Description	Zones 1-4
-	TUBULAR LEG	228
-	METAL SLED BASE	228
-	THERMOFORM TABLE TOP FOR 15-OT	781
-	LAMINATE TABLE TOP FOR 15-OT	919
-	THERMOFORM TABLE TOP FOR 15-OT-M	434
-	LAMINATE TABLE TOP FOR 15-OT-M	644
-	GANGING OPTION 1 ARM CHAIR ON ARMLESS SIDE ONLY	125
-	GANGING - ARMLESS, CORNER, INLINE OTTOMAN AND 1-ARM CHAIR ON BOTH SIDES	184
-	GANGING - SQUARE OTTOMAN	308
-	CHILL POWER	573

## MOMENT

Product No	Description	COM Ydg	Moist. Barrier	Zone 1	Zone 2	Zone 3	Zone 4
57111	CHAIR	6.25 yd	Included	3612	3702	3793	3883
57112	LOVESEAT	9 yd	Included	6112	6265	6418	6570
57113	SOFA	13.5 yd	Included	7489	7676	7863	8051

## RALLY

Product No	Description	COM Ydg	Moist. Barrier	Zone 1	Zone 2	Zone 3	Zone 4
64331	ASPIRE CHAIR	6.25 yd	Included	3486	3573	3660	3747
64131	ASPIRE CHAIR WITH 1 UPH ARM	5 yd	Included	3230	3311	3392	3472
64332	ASPIRE LOVESEAT	8.5 yd	Included	5429	5565	5700	5836
64132	ASPIRE LOVESEAT WITH 1 UPH ARM	7.25 yd	Included	5180	5310	5439	5568
64333	ASPIRE SOFA	10.75 yd	Included	7007	7182	7357	7533
64133	ASPIRE SOFA WITH 1 UPH ARM	9.5 yd	Included	6756	6925	7094	7263

Premium Fabric Grades	B	C	D	E	F	G	H	I	J	K	L
Multiply by COM Ydg	16	36	55	79	119	158	198	237	277	356	435

Available for an upcharge. List price per yard.

\*eQuote is available for live configuration pricing. Contact customer service or sales representative with questions.

# LIVING ROOM

## RALLY

Product No	Description	COM Ydg	Moist. Barrier	Zone 1	Zone 2	Zone 3	Zone 4
64311	EMBRACE CHAIR	6.25 yd	Included	3462	3549	3635	3722
64111	EMBRACE CHAIR WITH 1 UPH ARM	4.75 yd	Included	3205	3285	3365	3445
64312	EMBRACE LOVESEAT	8.5 yd	Included	5392	5527	5662	5796
64112	EMBRACE LOVESEAT WITH 1 UPH ARM	7 yd	Included	5139	5267	5396	5524
64313	EMBRACE SOFA	10.75 yd	Included	6956	7130	7304	7478
64113	EMBRACE SOFA WITH 1 UPH ARM	9.25 yd	Included	6701	6869	7036	7204
64321	INDULGE CHAIR	5.5 yd	Included	3462	3549	3635	3722
64121	INDULGE CHAIR WITH 1 UPH ARM	4.5 yd	Included	3205	3285	3365	3445
64322	INDULGE LOVESEAT	8 yd	Included	5392	5527	5662	5796
64122	INDULGE LOVESEAT WITH 1 UPH ARM	7 yd	Included	5139	5267	5396	5524
64323	INDULGE SOFA	10.25 yd	Included	6956	7130	7304	7478
64123	INDULGE SOFA WITH 1 UPH ARM	9.25 yd	Included	6701	6869	7036	7204
64371	RISE CHAIR	6 yd	Included	3462	3549	3635	3722
64171	RISE CHAIR WITH 1 UPH ARM	4.5 yd	Included	3205	3285	3365	3445
64372	RISE LOVESEAT	8.25 yd	Included	5392	5527	5662	5796
64172	RISE LOVESEAT WITH 1 UPH ARM	6.75 yd	Included	5139	5267	5396	5524
64373	RISE SOFA	10.5 yd	Included	6956	7130	7304	7478
64173	RISE SOFA WITH 1 UPH ARM	9.25 yd	Included	6701	6869	7036	7204
64361	UNWIND CHAIR	5.5 yd	Included	3462	3549	3635	3722
64161	UNWIND CHAIR WITH 1 UPH ARM	4.5 yd	Included	3205	3285	3365	3445
64362	UNWIND LOVESEAT	8 yd	Included	5392	5527	5662	5796
64162	UNWIND LOVESEAT WITH 1 UPH ARM	7 yd	Included	5139	5267	5396	5524
64363	UNWIND SOFA	10.25 yd	Included	6956	7130	7304	7478
64163	UNWIND SOFA WITH 1 UPH ARM	9.25 yd	Included	6701	6869	7036	7204
64401	ARMLESS CHAIR	3.5 yd	Included	2383	2443	2502	2562
64441	CORNER CHAIR	4.75 yd	Included	3608	3698	3788	3879
64-OT	OTTOMAN	3 yd	Included	1674	1716	1758	1800

## RALLY OPTIONS

Product No	Description	Zones 1-4
-	RALLY MOBILITY CASTERS	305
-	RALLY SLED BASE OPTION	132
-	RALLY MID-BACK CORNER OPTION	336
-	RALLY MID-BACK LOVESEAT	336
-	RALLY MID-BACK SOFA	498
-	RALLY MID-BACK OPTION	166
-	RALLY EMBRACE ARM CAP	169
-	RALLY STANDARD TABLE TOP SURFACE FOR OTTOMAN	1585
-	RALLY LOW TABLE TOP SURFACE FOR OTTOMAN	566
-	RALLY STANDARD TABLE TOP OTTOMAN LAMINATE	1563
-	RALLY 64-OT LOW OTTOMAN LAMINATE	757

Premium Fabric Grades	B	C	D	E	F	G	H	I	J	K	L
Multiply by COM Ydg	16	36	55	79	119	158	198	237	277	356	435

Available for an upcharge. List price per yard.

\*eQuote is available for live configuration pricing. Contact customer service or sales representative with questions.

# LIVING ROOM

RIO							
Product No	Description	COM Ydg	Moist. Barrier	Zone 1	Zone 2	Zone 3	Zone 4
<b>7977093</b>	CHAIR	7 yd	\$84	2735	2803	2872	2940
<b>7977092</b>	LOVESEAT	9 yd	\$108	3839	3935	4031	4127
<b>7977091</b>	SOFA	11 yd	\$132	4592	4707	4822	4936
4000 SERIES RECLINERS							
Product No	Description	COM Ydg	Moist. Barrier	Zone 1	Zone 2	Zone 3	Zone 4
<b>7977146</b>	RECLINER	9 yd	\$108	2967	3041	3115	3190

Premium Fabric Grades	B	C	D	E	F	G	H	I	J	K	L
<b>Multiply by COM Ydg</b>	16	36	55	79	119	158	198	237	277	356	435
Available for an upcharge. List price per yard.											

*\*eQuote is available for live configuration pricing. Contact customer service or sales representative with questions.*

# WOOD SEATING

## CLASSIC

Product No	Description	COM Ydg	Moist. Barrier	Zone 1	Zone 2	Zone 3	Zone 4
7973020	CLASSIC CHAIR	2 yd	24	1949	1998	2046	2095
7973021	CLASSIC LOVESEAT	4 yd	48	2799	2869	2939	3009
7973022	CLASSIC SOFA	6 yd	72	3432	3518	3604	3689
7979205	CLASSIC ARM CUSHION PAIR	1 yd	-	372	381	391	400

## MISSION

Product No	Description	COM Ydg	Moist. Barrier	Zone 1	Zone 2	Zone 3	Zone 4
7973070	MISSION CHAIR	2 yd	24	2505	2568	2630	2693
7973071	MISSION LOVESEAT	4 yd	48	3628	3719	3809	3900
7973072	MISSION SOFA	6 yd	72	4403	4513	4623	4733
7979107	FIXED CUSHION REPLACEMENT FOR CLASSIC/MISSION	2.25 yd	-	1394	1429	1464	1499
7979322	FIXED REPLACEMENT CUSHION COVERS FOR CLASSIC/ MISSION	2.25 yd	-	416	426	437	447

## CLASSIC/MISSION CUSHION REPLACEMENT

Product No	Description	COM Ydg	Moist. Barrier	Zone 1	Zone 2	Zone 3	Zone 4
7979203	REPLACEMENT SEAT CUSHION FOR CLASSIC/MISSION	1.75 yd	Included	434	445	456	467
7979204	REPLACEMENT SEAT BACK FOR CLASSIC/MISSION	1.25 yd	Included	270	277	284	290
7979207	CLASSIC/MISSION OVERSTUFFED REPLACEMENT CUSHION SET	3.25 yd	Included	818	838	859	879
7979201	REPLACEMENT SEAT COVERS FOR CLASSIC/MISSION	1.75 yd	Included	182	187	191	196
7979202	REPLACEMENT BACK COVERS FOR CLASSIC/MISSION	1.25 yd	Included	151	155	159	162
7921258	CLASSIC REPLACEMENT WOOD SEAT	-	-	284	291	298	305
7921259	CLASSIC REPLACEMENT WOOD BACK	-	-	299	306	314	321
7929212	CLASSIC ARM/SIDE CHAIR REPLACEMENT SEAT	-	-	207	212	217	223
7929213	CLASSIC ARM/SIDE CHAIR REPLACEMENT BACK	-	-	180	184	189	194

## CLASSIC MISSION FOAM

Product No	Description	COM Ydg	Moist. Barrier	Zone 1	Zone 2	Zone 3	Zone 4
7979230	REPLACEMENT SEAT FOAM FOR CLASSIC/MISSION	-	-	237	243	249	255
7979231	REPLACEMENT BACK FOAM FOR CLASSIC/MISSION	-	-	133	136	140	143
7979232	REPLACEMENT SEAT HIGH DENSITY FOAM FOR CLASSIC/ MISSION	-	-	307	315	322	330
7979233	REPLACEMENT BACK HIGH DENSITY FOAM FOR CLASSIC/ MISSION	-	-	201	206	211	216
7979234	OVERSTUFFED REPLACEMENT SEAT FOAM FOR CLASSIC/ MISSION	-	-	273	280	287	293
7979235	OVERSTUFFED REPLACEMENT BACK FOAM FOR CLASSIC/ MISSION	-	-	232	238	244	249

## LEGACY

Product No	Description	COM Ydg	Moist. Barrier	Zone 1	Zone 2	Zone 3	Zone 4
7973033	LEGACY CHAIR	2 yd	24	1966	2015	2064	2113
7973032	LEGACY LOVESEAT	4 yd	48	2821	2892	2962	3033
7973031	LEGACY SOFA	6 yd	72	3463	3550	3636	3723

Premium Fabric Grades	B	C	D	E	F	G	H	I	J	K	L
Multiply by COM Ydg	16	36	55	79	119	158	198	237	277	356	435

Available for an upcharge. List price per yard.

*\*eQuote is available for live configuration pricing. Contact customer service or sales representative with questions.*

# WOOD SEATING

## LEGACY REPLACEMENT FOAM

Product No	Description	COM Ydg	Moist. Barrier	Zone 1	Zone 2	Zone 3	Zone 4
<b>7979240</b>	REPLACEMENT SEAT FOAM FOR LEGACY	-	-	307	315	322	330
<b>7979241</b>	REPLACEMENT BACK FOAM FOR LEGACY	-	-	134	137	141	144

## LEGACY ACCESSORIES

Product No	Description	COM Ydg	Moist. Barrier	Zone 1	Zone 2	Zone 3	Zone 4
<b>7979601</b>	REPLACEMENT SEAT CUSHION FOR LEGACY	1.75 yd	21	424	435	445	456
<b>7979602</b>	REPLACEMENT BACK CUSHION FOR LEGACY	1.25 yd	15	272	279	286	292
<b>7979603</b>	REPLACEMENT CUSHION SET FOR LEGACY	1.75 yd	21	681	698	715	732
<b>7979604</b>	REPLACEMENT SEAT COVER FOR LEGACY	1.25 yd	-	183	188	192	197
<b>7979605</b>	REPLACEMENT BACK COVER FOR LEGACY	2 yd	-	152	156	160	163

Premium Fabric Grades	B	C	D	E	F	G	H	I	J	K	L
<b>Multiply by COM Ydg</b>	16	36	55	79	119	158	198	237	277	356	435
Available for an upcharge. List price per yard.											

*\*eQuote is available for live configuration pricing. Contact customer service or sales representative with questions.*

# OCCASIONAL AND DINING TABLES

## ALLY OCCASIONAL

Product No	Description	Zone 1	Zone 2	Zone 3	Zone 4
8824DAPL18	OCCASIONAL TABLE, 24" DIA, 18" HT	1042	1068	1094	1120
8830DAPL18	OCCASIONAL TABLE, 30" DIA, 18" HT	1208	1238	1268	1299
8836DAPL18	OCCASIONAL TABLE, 36"DIA, 18"HT	1366	1400	1434	1468
8842DAPL18	OCCASIONAL TABLE, 42" DIA, 18" HT	1825	1871	1916	1962
881818SQAPL18	OCCASIONAL TABLE, 18" SQ, 18" HT	1073	1100	1127	1153
882424SQAPL18	OCCASIONAL TABLE, 24" SQ, 18" HT	1092	1119	1147	1174
883030SQAPL18	OCCASIONAL TABLE, 30"SQ, 18"H	1264	1296	1327	1359
883636SQAPL18	OCCASIONAL TABLE, 36"SQ, 18"HT	1398	1433	1468	1503
882448REAPL18	OCCASIONAL TABLE, 24"X48"RECT, 18"HT	1352	1386	1420	1453

## ATWOOD

Product No	Description	Zone 1	Zone 2	Zone 3	Zone 4
7963416	SIDE TABLE	831	852	873	893
7963417	COFFEE TABLE	973	997	1022	1046

## CANTON

Product No	Description	Zone 1	Zone 2	Zone 3	Zone 4
67CN2424SQ	FREESTANDING END TABLE, 24"SQ, 18"H	1030	1056	1082	1107
67CN3030SQ	FREESTANDING END TABLE, 30"SQ, 18"H	1200	1230	1260	1290
67CN22DIA	FREESTANDING END TABLE, 22"DIA, 18"H	1288	1320	1352	1385
67CN2448RE	FREESTANDING COFFEE TABLE, 24"X48"RECT,18"H	1291	1323	1356	1388

## CLASSIC

Product No	Description	Zone 1	Zone 2	Zone 3	Zone 4
7963401	CLASSIC END TABLE	911	934	957	979
7963402	CLASSIC COFFEE TABLE	1050	1076	1102	1129

## DANBURY

Product No	Description	Zone 1	Zone 2	Zone 3	Zone 4
7963441	SIDE TABLE	1039	1065	1091	1117
7963442	COFFEE TABLE	1302	1335	1367	1400

## DRUM AND CUBE

Product No	Description	Zone 1	Zone 2	Zone 3	Zone 4
0118D16H	OCCASIONAL TABLE, 18"DIA, 16"H	1281	1313	1345	1377
0118D18H	OCCASIONAL TABLE, 18"DIA, 18"H	1281	1313	1345	1377
0118D20H	OCCASIONAL TABLE, 18"DIA, 20"H	1281	1313	1345	1377
0118D22H	OCCASIONAL TABLE, 18"DIA, 22"H	1281	1313	1345	1377
0124D16H	OCCASIONAL TABLE, 24"DIA, 16"H	1352	1386	1420	1453
0124D18H	OCCASIONAL TABLE, 24"DIA, 18"H	1352	1386	1420	1453
0124D20H	OCCASIONAL TABLE, 24"DIA, 20"H	1352	1386	1420	1453
0124D22H	OCCASIONAL TABLE, 24"DIA, 22"H	1352	1386	1420	1453
0130D16H	OCCASIONAL TABLE, 30"DIA, 16"H	1697	1739	1782	1824
0130D18H	OCCASIONAL TABLE, 30"DIA, 18"H	1697	1739	1782	1824
0130D20H	OCCASIONAL TABLE, 30"DIA, 20"H	1697	1739	1782	1824
0130D22H	OCCASIONAL TABLE, 30"DIA, 22"H	1697	1739	1782	1824
0136D16H	OCCASIONAL TABLE, 36"DIA, 16"H	1923	1971	2019	2067

## OCCASIONAL AND DINING TABLES

DRUM AND CUBE					
Product No	Description	Zone 1	Zone 2	Zone 3	Zone 4
0136D18H	OCCASIONAL TABLE, 36"DIA, 18"H	1923	1971	2019	2067
0136D20H	OCCASIONAL TABLE, 36"DIA, 20"H	1923	1971	2019	2067
0136D22H	OCCASIONAL TABLE, 36"DIA, 22"H	1923	1971	2019	2067
0142D16H	OCCASIONAL TABLE, 42"DIA, 16"H	2134	2187	2241	2294
0142D18H	OCCASIONAL TABLE, 42"DIA, 18"H	2134	2187	2241	2294
0142D20H	OCCASIONAL TABLE, 42"DIA, 20"H	2134	2187	2241	2294
0142D22H	OCCASIONAL TABLE, 42"DIA, 22"H	2134	2187	2241	2294
0118SQ16H	CUBE OCCASIONAL TABLE, 18" SQ, 16" H	972	996	1021	1045
0118SQ18H	CUBE OCCASIONAL TABLE, 18" SQ, 18" H	972	996	1021	1045
0118SQ20H	CUBE OCCASIONAL TABLE, 18" SQ, 20" H	972	996	1021	1045
0118SQ22H	CUBE OCCASIONAL TABLE, 18" SQ, 22" H	972	996	1021	1045
0124SQ16H	CUBE OCCASIONAL TABLE, 24" SQ, 16" H	1025	1051	1076	1102
0124SQ18H	CUBE OCCASIONAL TABLE, 24" SQ, 18" H	1025	1051	1076	1102
0124SQ20H	CUBE OCCASIONAL TABLE, 24" SQ, 20" H	1025	1051	1076	1102
0124SQ22H	CUBE OCCASIONAL TABLE, 24" SQ, 22" H	1025	1051	1076	1102
0130SQ16H	CUBE OCCASIONAL TABLE, 30" SQ, 16" H	1286	1318	1350	1382
0130SQ18H	CUBE OCCASIONAL TABLE, 30" SQ, 18" H	1286	1318	1350	1382
0130SQ20H	CUBE OCCASIONAL TABLE, 30" SQ, 20" H	1286	1318	1350	1382
0130SQ22H	CUBE OCCASIONAL TABLE, 30" SQ, 22" HT	1286	1318	1350	1382
0136SQ16H	CUBE OCCASIONAL TABLE, 36" SQ, 16" H	1496	1533	1571	1608
0136SQ18H	CUBE OCCASIONAL TABLE, 36" SQ, 18" H	1496	1533	1571	1608
0136SQ20H	CUBE OCCASIONAL TABLE, 36" SQ, 20" H	1496	1533	1571	1608
0136SQ22H	CUBE OCCASIONAL TABLE, 36" SQ, 22" H	1496	1533	1571	1608
DRUM AND CUBE OPTIONS					
Product No	Description	Zones 1-4			
-	2" ALUMINUM KICKPLATE UPCHARGE	81			
-	POWER - IN-SURFACE CLAMP MOUNT	687			
LEGACY					
Product No	Description	Zone 1	Zone 2	Zone 3	Zone 4
7963406	LEGACY END TABLE, 21"SQ, 19"H	920	943	966	989
7963408	LEGACY COFFEE TABLE, 21"X45" RECT, 18"H	1060	1086	1113	1140
9583636	LEGACY AV CONSOLE	1997	2047	2097	2147
MISSION					
Product No	Description	Zone 1	Zone 2	Zone 3	Zone 4
7963421	MISSION END TABLE	936	959	983	1006
7963422	MISSION COFFEE TABLE	1088	1115	1142	1170
ROWAN					
Product No	Description	Zone 1	Zone 2	Zone 3	Zone 4
7963419	ROWAN END TABLE, 19"SQ, 21"H	907	930	952	975
7963420	ROWAN COFFEE TABLE, 19"X31" REC, 24"H	1155	1184	1213	1242

## OCCASIONAL AND DINING TABLES

### TRUMPET & DISC OCCASIONAL

Product No	Description	Zone 1	Zone 2	Zone 3	Zone 4
8724DDISC18	DISC OCCASIONAL TABLE, 24"DIA, 18"H	1576	1615	1655	1694
8730DDISC18	DISC OCCASIONAL TABLE, 30"DIA, 18"H	1743	1787	1830	1874
8736DDISC18	DISC OCCASIONAL TABLE, 36"DIA, 18"H	1903	1951	1998	2046
8742DDISC18	DISC OCCASIONAL TABLE, 42"DIA, 18"H	2366	2425	2484	2543
8718SQDISC18	DISC OCCASIONAL TABLE, 18"SQ, 18"H	1605	1645	1685	1725
8724SQDISC18	DISC OCCASIONAL TABLE, 24"SQ, 18"H	1624	1665	1705	1746
8730SQDISC18	DISC OCCASIONAL TABLE, 30"SQ, 18"H	1798	1843	1888	1933
8736SQDISC18	DISC OCCASIONAL TABLE, 36"SQ, 18"H	1934	1982	2031	2079
8724DTR18	OCCASIONAL TABLE, 24"DIA, 18"H	1064	1091	1117	1144
8730DTR18	OCCASIONAL TABLE, 30"DIA, 18"H	1233	1264	1295	1325
8736DTR18	OCCASIONAL TABLE, 36"DIA, 18"H	1395	1430	1465	1500
8742DTR18	OCCASIONAL TABLE, 42"DIA, 18"H	1855	1901	1948	1994
8718SQTR18	OCCASIONAL TABLE, 18"SQ, 18"H	1098	1125	1153	1180
8724SQTR18	OCCASIONAL TABLE, 24"SQ, 18"H	1115	1143	1171	1199
8730SQTR18	OCCASIONAL TABLE, 30"SQ, 18"H	1288	1320	1352	1385
8736SQTR18	OCCASIONAL TABLE, 36"SQ, 18"H	1425	1461	1496	1532

### ALLY MULTI-PURPOSE

Product No	Description	Zone 1	Zone 2	Zone 3	Zone 4
8824DAPL	MULTI-PURPOSE TABLE, 24"DIA, 29"HT	1042	1068	1094	1120
8830DAPL	MULTI-PURPOSE TABLE, 30"DIA, 29"H	1208	1238	1268	1299
8836DAPL	MULTI-PURPOSE TABLE, 36"DIA, 29"HT	1366	1400	1434	1468
8842DAPL	MULTI-PURPOSE TABLE, 42"DIA, 29"H	1825	1871	1916	1962
8848DAPL	MULTI-PURPOSE TABLE, 48"DIA, 29"H	1862	1909	1955	2002
8860DAPL	MULTI-PURPOSE TABLE, 60"DIA, 29"H	2402	2462	2522	2582
882424SQAPL	MULTI-PURPOSE TABLE, 24"SQ, 29"HT	1092	1119	1147	1174
883030SQAPL	MULTI-PURPOSE TABLE, 30"SQ, 29"H	1264	1296	1327	1359
883636SQAPL	MULTI-PURPOSE TABLE, 36"SQ, 29"HT	1398	1433	1468	1503
884242SQAPL	MULTI-PURPOSE TABLE, 42"SQ, 29"H	1850	1896	1942	1989
882430REAPL	MULTI-PURPOSE TABLE, 24"X30"RECT, 29"H	1244	1275	1306	1337
882436REAPL	MULTI-PURPOSE TABLE, 24"X36" RECT, 29"H	1244	1275	1306	1337
882442REAPL	MULTI-PURPOSE TABLE, 24"X42" RECT, 29"H	1352	1386	1420	1453
882448REAPL	MULTI-PURPOSE TABLE, 24"X48"RECT, 29"H	1352	1386	1420	1453
882460REAPL	MULTI-PURPOSE TABLE, 24"X 60"RECT, 29"H	1447	1483	1519	1556
882472REAPL	MULTI-PURPOSE TABLE, 24"X 72"RECT, 29"H	1874	1921	1968	2015
883036REAPL	MULTI PURPOSE TABLE, 30"X36"RECT, 29"H	1396	1431	1466	1501
883042REAPL	MULTI-PURPOSE TABLE, 30"X42"RECT, 29"H	1432	1468	1504	1539
883048REAPL	MULTI-PURPOSE TABLE, 30"X48"RECT, 29"H	1432	1468	1504	1539
883060REAPL	MULTI-PURPOSE TABLE, 30"X60"RECT, 29"H	1531	1569	1608	1646
883072REAPL	MULTI-PURPOSE TABLE, 30"X72"RECT, 29"H	2094	2146	2199	2251
883642REAPL	MULTI PURPOSE TABLE, 36"X42"RECT, 29"H	1596	1636	1676	1716
883648REAPL	MULTI PURPOSE TABLE, 36"X48"RECT, 29"H	1637	1678	1719	1760
883660REAPL	MULTI PURPOSE TABLE, 36"X60"RECT, 29"H	1796	1841	1886	1931
883672REAPL	MULTI PURPOSE TABLE, 36"X72"RECT, 29"H	2189	2244	2298	2353

# OCCASIONAL AND DINING TABLES

## ALLY MULTI-PURPOSE OPTIONS

Product No	Description	Zones 1-4
CTRS	2 ROUND SURFACE GROMMET	42
CTRG	3X5 OVAL SURFACE GROMMET	67
VELCROWIREMGR	VELCRO WIRE MANAGEMENT	21
CWMT	PVC SNAP TO LEG WIRE MANAGEMENT	64
CSC	SEAM CONNECTOR, 2 CONN, 4 THUMB SCREWS, 4 COUNTER SUNK THREAD. METAL INSRT	155

## CAFÉ

Product No	Description	Zone 1	Zone 2	Zone 3	Zone 4
7954041	CAFE TABLE - 28" SQUARE	1057	1083	1110	1136
7954042	CAFE TABLE - 36" SQUARE	1289	1321	1353	1386

## CLASSIC LEG

Product No	Description	Zone 1	Zone 2	Zone 3	Zone 4
7964070	CLASSIC TABLE, SQUARE	1745	1789	1832	1876
7964071	CLASSIC TABLE, MEDIUM RECTANGLE	2005	2055	2105	2155
7964072	CLASSIC TABLE, LARGE RECTANGLE	2572	2636	2701	2765
7964073	CLASSIC TABLE, ROUND	2042	2093	2144	2195

## CLASSIC TRESTLE

Product No	Description	Zone 1	Zone 2	Zone 3	Zone 4
7954074	CLASSIC TRESTLE,MEDIUM RECTANGLE	1594	1634	1674	1714
7954075	CLASSIC TRESTLE,LARGE RECTANGLE	2050	2101	2152	2204
7954090	CLASSIC TABLE, SQUARE, WOOD TOP	1009	1034	1059	1085
7954091	CLASSIC TABLE, MEDIUM RECTANGLE, WOOD TOP	1222	1253	1283	1314
7954092	CLASSIC TABLE, LARGE RECTANGLE, WOOD TOP	1328	1361	1394	1428
7954093	CLASSIC TRESTLE TABLE, MEDIUM RECTANGLE, WOOD TOP	1091	1118	1146	1173
7954094	CLASSIC TRESTLE TABLE, LARGE RECTANGLE, WOOD TOP	1101	1129	1156	1184

## KEATON TRESTLE

Product No	Description	Zone 1	Zone 2	Zone 3	Zone 4
7954080	KEATON TRESTLE TABLE, MEDIUM, 6 SEAT	1710	1753	1796	1838
7954081	KEATON TRESTLE TABLE, LARGE, 8 SEAT	2107	2160	2212	2265

## ROWAN METAL DINING

Product No	Description	Zone 1	Zone 2	Zone 3	Zone 4
7964076	ROWAN DINING TABLE, 36"SQ, 30"H	1152	1181	1210	1238

## TAPERED LEG

Product No	Description	Zone 1	Zone 2	Zone 3	Zone 4
7954032	TAPERED LEG TABLE,42" ROUND, 30" HEIGHT	1674	1716	1758	1800
7954033	TAPERED LEG TABLE,36" SQUARE, 30" HEIGHT	1410	1445	1480	1516
7954034	TAPERED LEG TABLE, MEDIUM RECTANGLE 36"X60"X30" HEIGHT	1595	1635	1675	1715
7954036	TAPERED LEG TABLE, LARGE RECTANGLE 36"X84"X30" HEIGHT	2008	2058	2108	2159

# OCCASIONAL AND DINING TABLES

## TRUMPET & DISC

Product No	Description	Zone 1	Zone 2	Zone 3	Zone 4
8724DTR29	MULTI-PURPOSE TABLE, 24"DIA, 29"H	1064	1091	1117	1144
8730DTR29	MULTI-PURPOSE TABLE, 30"DIA, 29"H	1233	1264	1295	1325
8736DTR29	MULTI-PURPOSE TABLE, 36"DIA, 29"H	1395	1430	1465	1500
8742DTR29	MULTI-PURPOSE TABLE, 42"DIA, 29"H	1855	1901	1948	1994
8748DTR29	MULTI-PURPOSE TABLE, 48"DIA, 29"H	1893	1940	1988	2035
8724SQTR29	MULTI-PURPOSE TABLE, 24"SQ, 29"H	1115	1143	1171	1199
8730SQTR29	MULTI-PURPOSE TABLE, 30"SQ, 29"H	1225	1256	1286	1317
8736SQTR29	MULTI-PURPOSE TABLE, 36"SQ, 29"H	1425	1461	1496	1532
8724DDISC29	DISC MULTI-PURPOSE TABLE, 24"DIA, 29"H	1576	1615	1655	1694
8730DDISC29	DISC MULTI-PURPOSE TABLE, 30"DIA, 29"H	1743	1787	1830	1874
8736DDISC29	DISC MULTI-PURPOSE TABLE, 36"DIA, 29"H	1903	1951	1998	2046
8742DDISC29	DISC MULTI-PURPOSE TABLE, 42"DIA, 29"H	2366	2425	2484	2543
8748DDISC29	DISC MULTI-PURPOSE TABLE, 48"DIA, 29"H	2404	2464	2524	2584
8730SQDISC29	DISC MULTI- PURPOSE TABLE, 30"SQ, 29"H	1798	1843	1888	1933
8736SQDISC29	DISC MULTI-PURPOSE TABLE, 36"SQ, 29"H	1934	1982	2031	2079

## TUBULAR

Product No	Description	Zone 1	Zone 2	Zone 3	Zone 4
8624DX	MULTI-PURPOSE TABLE, 24"DIA, 29"H, X-BASE	855	876	898	919
8630DX	MULTI-PURPOSE TABLE, 30"DIA, 29"H, X-BASE	1027	1053	1078	1104
8636DX	MULTI-PURPOSE TABLE, 36"DIA, 29"H, X-BASE	1190	1220	1250	1279
8642DX	MULTI-PURPOSE TABLE, 42"DIA, X-BASE	1658	1699	1741	1782
8648DX	MULTI-PURPOSE TABLE, 48"DIA,29"H, X-BASE	1697	1739	1782	1824
8624SQX	MULTI-PURPOSE TABLE, 24"SQ, 29"H, X-BASE	907	930	952	975
8630SQX	MULTI-PURPOSE TABLE, 30"SQ, 29"H, X-BASE	1084	1111	1138	1165
8636SQX	MULTI-PURPOSE TABLE, 36"SQ, 29"H, X-BASE	1221	1252	1282	1313
8642SQX	MULTI-PURPOSE TABLE, 42"SQ, 29"H, X-BASE	1937	1985	2034	2082
862430REX	MULTI-PURPOSE TABLE, 24"X30"RECT, 29"H X-BASE	1065	1092	1118	1145
862436REX	MULTI-PURPOSE TABLE, 24"X36"RECT, 29"H, X-BASE	1065	1092	1118	1145
863036REX	MULTI-PURPOSE TABLE, 30"X36"RECT, 29"H X-BASE	1221	1252	1282	1313
863042REX	MULTI-PURPOSE TABLE, 30"X42"RECT, 29"H X-BASE	1257	1288	1320	1351
863048REX	MULTI-PURPOSE TABLE, 30"X48"RECT, 29"H, X-BASE	1257	1288	1320	1351
8624DX41	BAR HEIGHT TABLE, 24"DIA, 41"H, X-BASE	920	943	966	989
8630DX41	BAR HEIGHT TABLE, 30"DIA, 41"H, X-BASE	1091	1118	1146	1173
8630DX41	BAR HEIGHT TABLE, 30"DIA, 41"H, X-BASE	1091	1118	1146	1173
8624SQX41	BAR HEIGHT TABLE, 24"SQ, 41"H, X-BASE	972	996	1021	1045
8630SQX41	BAR HEIGHT TABLE, 30"SQ, 41"H, X-BASE	1150	1179	1208	1236
8636SQX41	BAR HEIGHT TABLE, 36"SQ, 41"H, X-BASE	1286	1318	1350	1382
8642DX4	MULTI-PURPOSE TABLE, 42"DIA, 29"H, 4-COLUMN X-BASE	1982	2032	2081	2131
8648DX4	MULTI-PURPOSE TABLE, 48"DIA, 29"H, 4-COLUMN X-BASE	2021	2072	2122	2173
8654DX4	MULTI-PURPOSE TABLE, 54"DIA, 29"H, 4-COLUMN X-BASE	2497	2559	2622	2684
8660DX4	MULTI-PURPOSE TABLE, 60"DIA, 29"H, 4-COLUMN X-BASE	2572	2636	2701	2765
8642SQX4	MULTI-PURPOSE TABLE, 42"SQ, 29"H, 4-COLUMN X-BASE	2005	2055	2105	2155
8654SQX4	MULTI-PURPOSE TABLE, 54"SQ, 29"H, 4-COLUMN X-BASE	2502	2565	2627	2690
8660SQX4	MULTI-PURPOSE TABLE, 60"SQ, 29"H, 4-COLUMN X-BASE	2555	2619	2683	2747
862430RET	MULTI-PURPOSE TABLE, 24"X30"RECT, 29"H, T-BASE	1248	1279	1310	1342
862436RET	MULTI-PURPOSE TABLE, 24"X36"RECT, 29"H, T-BASE	1248	1279	1310	1342

# OCCASIONAL AND DINING TABLES

TUBULAR					
Product No	Description	Zone 1	Zone 2	Zone 3	Zone 4
862442RET	MULTI-PURPOSE TABLE, 24"X42"RECT, 29"H T-BASE	1357	1391	1425	1459
862448RET	MULTI-PURPOSE TABLE, 24"X48"RECT, 29"H, T-BASE	1357	1391	1425	1459
862454RET	MULTI-PURPOSE TABLE, 24"X54"RECT, 29"H T-BASE	1456	1492	1529	1565
862460RET	MULTI-PURPOSE TABLE, 24"X60"RECT, 29"H T-BASE	1456	1492	1529	1565
862466RET	MULTI-PURPOSE TABLE, 24"X66"RECT, 29"H T-BASE	1701	1744	1786	1829
862472RET	MULTI-PURPOSE TABLE, 24"X72"RECT, 29"H T-BASE	1701	1744	1786	1829
863036RET	MULTI-PURPOSE TABLE, 30"X36"RECT, 29"H, T-BASE	1404	1439	1474	1509
863042RET	MULTI-PURPOSE TABLE, 30"X42"RECT, 29"H T-BASE	1440	1476	1512	1548
863048RET	MULTI-PURPOSE TABLE, 30"X48"RECT, 29"H, T-BASE	1440	1476	1512	1548
863054RET	MULTI-PURPOSE TABLE, 30"X54"RECT, 29"H T-BASE	1535	1573	1612	1650
863060RET	MULTI-PURPOSE TABLE, 30"X60"RECT, 29"H T-BASE	1535	1573	1612	1650
863066RET	MULTI-PURPOSE TABLE, 30"X66"RECT, 29"H, T-BASE	1829	1875	1920	1966
863072RET	MULTI-PURPOSE TABLE, 30"X72"RECT, 29"H T-BASE	1925	1973	2021	2069
863078RET	MULTI-PURPOSE TABLE, 30"X78"RECT, 29"H T-BASE	2303	2361	2418	2476
863084RET	MULTI-PURPOSE TABLE, 30"X84"RECT, 29"H T-BASE	2303	2361	2418	2476
863090RET	MULTI-PURPOSE TABLE, 30"X90"RECT, 29"H T-BASE	2339	2397	2456	2514
863096RET	MULTI-PURPOSE TABLE, 30"X96"RECT, 29"H, T-BASE	2339	2397	2456	2514
863642RET	MULTI-PURPOSE TABLE, 36"X42"RECT, 29"H, T-BASE	1609	1649	1689	1730
863648RET	MULTI-PURPOSE TABLE, 36" X 48" RECT, 29"H, T-BASE	1649	1690	1731	1773
863660RET	MULTI-PURPOSE TABLE, 36"X60"RECT, 29"H, T-BASE	1812	1857	1903	1948
863666RET	MULTI-PURPOSE TABLE, 36"X66"RECT, 29"H, T-BASE	1960	2009	2058	2107
863672RET	MULTI-PURPOSE TABLE, 36"X72"RECT, 29"H, T-BASE	2024	2075	2125	2176
863678RET	MULTI-PURPOSE TABLE, 36"X78"RECT, 29"H, T-BASE	2587	2652	2716	2781
863684RET	MULTI-PURPOSE TABLE, 36"X84"RECT, 29"H, T-BASE	2587	2652	2716	2781
863690RET	MULTI-PURPOSE TABLE, 36" X 90" RECT, 29"H, T-BASE	2597	2662	2727	2792
863696RET	MULTI-PURPOSE TABLE, 36"X96"RECT, 29"H, T-BASE	2597	2662	2727	2792
863654RTT	MULTI-PURPOSE TABLE, 36"X54" RACETRACK, 29"H, T-BASE	1905	1953	2000	2048
863660RTT	MULTI-PURPOSE TABLE, 36"X60" RACETRACK, 29"H, T-BASE	1905	1953	2000	2048
863666RTT	MULTI-PURPOSE TABLE, 36"X66" RACETRACK, 29"H, T-BASE	2171	2225	2280	2334
863672RTT	MULTI-PURPOSE TABLE, 36"X72" RACETRACK, 29"H, T-BASE	2171	2225	2280	2334
863678RTT	MULTI-PURPOSE TABLE, 36"X78" RACETRACK, 29"H, T-BASE	2615	2680	2746	2811
863684RTT	MULTI-PURPOSE TABLE, 36"X84" RACETRACK, 29"H, T-BASE	2615	2680	2746	2811
863690RTT	MULTI-PURPOSE TABLE, 36" X 90" RACETRACK, 29"H, T-BASE	2620	2686	2751	2816
863696RTT	MULTI-PURPOSE TABLE, 36"X96" RACETRACK, 29"H, T-BASE	2620	2686	2751	2816
863054BT	MULTI-PURPOSE TABLE, 30"X54" BULLET, 29"H, T-BASE	1740	1784	1827	1870
863060BT	MULTI-PURPOSE TABLE, 30"X60" BULLET, 29"H, T-BASE	1827	1873	1918	1964
863654BT	MULTI-PURPOSE TABLE, 36"X54" BULLET, 29"H, T-BASE	1944	1993	2041	2090
863660BT	MULTI-PURPOSE TABLE, 36"X60" BULLET, 29"H, T-BASE	1944	1993	2041	2090
863672BT	MULTI-PURPOSE TABLE, 36"X72" BULLET, 29"H, T-BASE	2169	2223	2277	2332
863666RET2	MULTI-PURPOSE TABLE, 36"X66" RECT, 29"H, DOUBLE COLUMN T-BASE	2295	2352	2410	2467
863672RET2	MULTI-PURPOSE TABLE, 36"X72"RECT, 29"H, DOUBLE COLUMN T-BASE	2356	2415	2474	2533
863678RET2	MULTI-PURPOSE TABLE, 36"X78"RECT, 29"H, DOUBLE COLUMN T-BASE	2920	2993	3066	3139
863684RET2	MULTI-PURPOSE TABLE, 36"X84"RECT, 29"H, DOUBLE COLUMN T-BASE	2920	2993	3066	3139
863690RET2	MULTI-PURPOSE TABLE, 36" X 90" RECT, 29"H, DOUBLE COLUMN T-BASE	2931	3004	3078	3151
863696RET2	MULTI-PURPOSE TABLE, 36"X96"RECT, 29"H, DOUBLE COLUMN T-BASE	2931	3004	3078	3151
864278RET2	MULTI-PURPOSE TABLE, 42"X78"RECT, 29"H, DOUBLE COLUMN T-BASE	3329	3412	3495	3579

## OCCASIONAL AND DINING TABLES

### TUBULAR

Product No	Description	Zone 1	Zone 2	Zone 3	Zone 4
<b>864284RET2</b>	MULTI-PURPOSE TABLE, 42"X84"RECT, 29"H, DOUBLE COLUMN T-BASE	3329	3412	3495	3579
<b>863654RTT2</b>	MULTI-PURPOSE TABLE, 36"X54", RACETRACK, 29"H, DOUBLE COLUMN T-BASE	2242	2298	2354	2410
<b>863660RTT2</b>	MULTI-PURPOSE TABLE, 36"X60" RACETRACK, 29"H, DOUBLE COLUMN T-BASE	2242	2298	2354	2410
<b>863666RTT2</b>	MULTI-PURPOSE TABLE, 36"X66" RACETRACK, 29"H, DOUBLE COLUMN T-BASE	2507	2570	2632	2695
<b>863672RTT2</b>	MULTI-PURPOSE TABLE, 36"X72" RACETRACK, 29"H, DOUBLE COLUMN T-BASE	2507	2570	2632	2695
<b>863678RTT2</b>	MULTI-PURPOSE TABLE, 36"X78" RACETRACK, 29"H, DOUBLE COLUMN T-BASE	2951	3025	3099	3172
<b>863684RTT2</b>	MULTI-PURPOSE TABLE, 36"X84" RACETRACK, 29"H, DOUBLE COLUMN T-BASE	2951	3025	3099	3172
<b>863690RTT2</b>	MULTI-PURPOSE TABLE, 36" X 90" RACETRACK, DOUBLE COLUMN T-BASE	2955	3029	3103	3177
<b>863696RTT2</b>	MULTI-PURPOSE TABLE, 36"X96" RACETRACK, 29"H, DOUBLE COLUMN T-BASE	2955	3029	3103	3177
<b>864278RTT2</b>	MULTI-PURPOSE TABLE, 42"X78" RACETRACK, 29"H, DOUBLE COLUMN T-BASE	3354	3438	3522	3606
<b>864284RTT2</b>	MULTI-PURPOSE TABLE, 42"X84" RACETRACK, 29"H, DOUBLE COLUMN T-BASE	3354	3438	3522	3606
<b>864878RTT2</b>	MULTI-PURPOSE TABLE, 48"X78" RACETRACK, 29"H, DOUBLE COLUMN T-BASE	3358	3442	3526	3610
<b>864884RTT2</b>	MULTI-PURPOSE TABLE, 48"X84" RACETRACK, 29"H, DOUBLE COLUMN T-BASE	3358	3442	3526	3610
<b>8624RC90</b>	CONNECTOR TABLE, 24" X 24" RADIUS	651	667	684	700
<b>8630RC90</b>	CONNECTOR TABLE, 30" X 30" RADIUS	830	851	872	892
<b>863036CRC90T</b>	CONNECTOR TABLE, 30" X 36" CRESCENT	1329	1362	1395	1429
<b>863642CRC90T</b>	CONNECTOR TABLE, 36" X 42" CRESCENT	1925	1973	2021	2069

### TUBULAR OPTIONS

Product No	Description	Zones 1-4
-	HARD CASTERS - TABLES < 72" (SOFT SURFACES) - PER TABLE	145
-	HARD CASTERS - TABLES >=72" (SOFT SURFACES) - PER TABLE	196
-	SOFT CASTERS - TABLES < 72" (SOFT SURFACES) - PER TABLE	315
-	SOFT CASTERS - TABLES >= 72" (HARD SURFACES) - PER TABLE	420
-	FLIP TOP OPTION TABLES (1 BASE)	240
-	FLIP TOP OPTION (2 BASE)	480
-	FOLDING TABLE OPTION FOR TABLES < 72"	987
-	FOLDING TABLE OPTION FOR TABLES >= 72"	1232
-	TUBULAR WHEELCHAIR HEIGHT OPTION (ADA)	64
-	POWER - IN-SURFACE CLAMP MOUNT	687
-	POWER - EDGE CLAMP-ON	596
<b>CWMT</b>	SNAP TO LEG WIRE MANAGER	64
<b>VELCROWIREMGR</b>	VELCRO WIRE MANAGER	21
<b>CTRS</b>	ROUND GROMMET	42
<b>CTRG</b>	OVAL GROMMET	67
<b>CSC</b>	SEAM CONNECTOR	155
-	MODESTY PANEL	482

# DINING CHAIRS

BISTRO							
Product No	Description	COM Ydg	Moist. Barrier	Zone 1	Zone 2	Zone 3	Zone 4
7924350	BISTRO SIDE CHAIR, METAL FRAME, UPH SEAT	.75 yd	-	747	766	784	803
7924360	BISTRO SIDE CHAIR, METAL FRAME, WOOD SEAT	-	-	653	669	686	702
7924351	BISTRO COUNTER STOOL, METAL FRAME, UPH SEAT	.75 yd	-	839	860	881	902
7924361	BISTRO COUNTER STOOL, METAL FRAME, WOOD SEAT	-	-	735	753	772	790
7924352	BISTRO BAR STOOL, METAL FRAME, UPH SEAT	.75 yd	-	948	972	995	1019
7924362	BISTRO BAR STOOL, METAL FRAME, WOOD SEAT	-	-	811	831	852	872
7929425	BISTRO REPLACEMENT SEAT CUSHION	.75 yd	-	219	224	230	235
7921257	BISTRO REPLACEMENT WOOD SEAT	-	-	284	291	298	305
BOWEN							
Product No	Description	COM Ydg	Moist. Barrier	Zone 1	Zone 2	Zone 3	Zone 4
7924346	BOWEN SIDE CHAIR, UPHOLSTERED SEAT	.75 yd	-	644	660	676	692
7924356	BOWEN SIDE CHAIR, ALL WOOD	-	-	581	596	610	625
7929427	BOWEN/CHANDLER REPLACEMENT SEAT CUSHION	.75 yd	-	209	214	219	225
7921278	BOWEN/CHANDLER REPLACEMENT WOOD SEAT	-	-	285	292	299	306
CHANDLER							
Product No	Description	COM Ydg	Moist. Barrier	Zone 1	Zone 2	Zone 3	Zone 4
7924345	CHANDLER SIDE CHAIR, UPH SEAT	.75 yd	-	591	606	621	635
7924355	CHANDLER SIDE CHAIR, ALL WOOD	-	-	565	579	593	607
7929427	BOWEN/CHANDLER REPLACEMENT SEAT CUSHION	.75 yd	-	209	214	219	225
7921278	BOWEN/CHANDLER REPLACEMENT WOOD SEAT	-	-	285	292	299	306
CLASSIC							
Product No	Description	COM Ydg	Moist. Barrier	Zone 1	Zone 2	Zone 3	Zone 4
7924301	CLASSIC SIDE CHAIR WITH UPH SEAT AND UPH BACK	1 yd	-	642	658	674	690
7924302	CLASSIC SIDE CHAIR WITH UPH SEAT AND WOOD BACK	.75 yd	-	655	671	688	704
7924303	CLASSIC SIDE CHAIR WITH WOOD SEAT AND WOOD BACK	-	-	644	660	676	692
7924304	CLASSIC ARM CHAIR WITH UPH SEAT AND UPH BACK	1 yd	-	661	678	694	711
7924305	CLASSIC ARM CHAIR WITH UPH SEAT AND WOOD BACK	.75 yd	-	669	686	702	719
7924306	CLASSIC ARM CHAIR WITH WOOD SEAT AND WOOD BACK	-	-	664	681	697	714
7924307	CLASSIC SLED BASE SIDE CHAIR WITH UPH SEAT AND UPH BACK	1 yd	-	648	664	680	697
7924308	CLASSIC SLED BASE SIDE CHAIR WITH UPH SEAT AND WOOD BACK	.75 yd	-	658	674	691	707
7924309	CLASSIC SLED BASE SIDE CHAIR WITH WOOD SEAT AND WOOD BACK	-	-	644	660	676	692
7924310	CLASSIC SLED BASE ARM CHAIR WITH UPH SEAT AND UPH BACK	1 yd	-	690	707	724	742
7924311	CLASSIC SLED BASE ARM CHAIR WITH UPH SEAT AND WOOD BACK	.75 yd	-	702	720	737	755
7924312	CLASSIC SLED BASE ARM CHAIR WITH WOOD SEAT AND WOOD BACK	-	-	693	710	728	745
7979205	CLASSIC ARM CUSHION PAIR	1 yd	-	372	381	391	400
7921258	CLASSIC REPLACEMENT WOOD SEAT	-	-	284	291	298	305
7921259	CLASSIC REPLACEMENT WOOD BACK	-	-	299	306	314	321
7929212	CLASSIC ARM/SIDE CHAIR REPLACEMENT SEAT	-	-	207	212	217	223
7929213	CLASSIC ARM/SIDE CHAIR REPLACEMENT BACK	-	-	180	184	189	194

Premium Fabric Grades	B	C	D	E	F	G	H	I	J	K	L
Multiply by COM Ydg	16	36	55	79	119	158	198	237	277	356	435

Available for an upcharge. List price per yard.

\*eQuote is available for live configuration pricing. Contact customer service or sales representative with questions.

# DINING CHAIRS

## DALTON

Product No	Description	COM Ydg	Moist. Barrier	Zone 1	Zone 2	Zone 3	Zone 4
7924344	DALTON SIDE CHAIR, UPH SEAT	.75 yd	-	665	682	698	715
7924354	DALTON SIDE CHAIR, ALL WOOD	-	-	598	613	628	643
7924358	DALTON ARM CHAIR, FABRIC SEAT	.75 yd	-	804	824	844	864
7924368	DALTON ARM CHAIR, WOOD SEAT	-	-	735	753	772	790
7929428	DALTON REPLACEMENT SEAT CUSHION	.75 yd	-	209	214	219	225
7921280	DALTON REPLACEMENT WOOD SEAT	-	-	274	281	288	295

## METAL STACK

Product No	Description	COM Ydg	Moist. Barrier	Zone 1	Zone 2	Zone 3	Zone 4
7924332	METAL SLED BASE STACK CHAIR	-	-	377	386	396	405
7924334	DOLLY FOR SLED BASE STACKING CHAIR	-	-	1656	1697	1739	1780

## PLYLOK

Product No	Description	COM Ydg	Moist. Barrier	Zone 1	Zone 2	Zone 3	Zone 4
7028742	SIDE CHAIR, UPH SEAT, STACKING	.8 yd	10	636	652	668	684
7328748	ARM CHAIR, UPH SEAT, STACKING	.8 yd	10	857	878	900	921
7023711	SIDE CHAIR, WOOD SEAT, STACKING	.5 yd	-	634	650	666	682
7323718	ARM CHAIR, WOOD SEAT, STACKING	.5 yd	-	855	876	898	919
7924377	QUICK SHIP SIDE CHAIR - ALL WOOD	-	-	634	650	666	682
7924378	QUICK SHIP ARM CHAIR - ALL WOOD	-	-	855	876	898	919

## PLYLOK OPTIONS

Product No	Description	Zones 1-4					
7074129	INTERLOCK, METAL, STRAIGHT	8					
7074130	INTERLOCK, METAL, RADIUS	47					

## PLYWEDGE

Product No	Description	COM Ydg	Moist. Barrier	Zone 1	Zone 2	Zone 3	Zone 4
7028760	SIDE CHAIR, UPH SEAT, ALL UPH BACK, NON-STACKING	1 yd	12	560	574	588	602
7023760	SIDE CHAIR, WOOD SEAT, WOOD BACK, NON-STACKING	-	-	560	574	588	602

## PLYWEDGE OPTIONS

Product No	Description	Zones 1-4					
7074129	INTERLOCK, METAL, STRAIGHT	8					
7074130	INTERLOCK, METAL, RADIUS	47					

## UPLAND

Product No	Description	COM Ydg	Moist. Barrier	Zone 1	Zone 2	Zone 3	Zone 4
69UP01	ARM CHAIR, POLY SEAT, PLASTIC BACK	-	-	601	616	631	646
69UP11	SIDE CHAIR, POLY SEAT, PLASTIC BACK	-	-	601	616	631	646
69UP02	ARM CHAIR, POLY SEAT, PLASTIC BACK, CASTERS	-	-	826	847	867	888
69UP31	ARM CHAIR, POLY SEAT, PLASTIC BACK, SLED BASE	-	-	764	783	802	821

Premium Fabric Grades	B	C	D	E	F	G	H	I	J	K	L
Multiply by COM Ydg	16	36	55	79	119	158	198	237	277	356	435

Available for an upcharge. List price per yard.

*\*eQuote is available for live configuration pricing. Contact customer service or sales representative with questions.*

# DINING CHAIRS

UPLAND							
Product No	Description	COM Ydg	Moist. Barrier	Zone 1	Zone 2	Zone 3	Zone 4
69UP41	SIDE CHAIR, POLY SEAT, PLASTIC BACK, SLED BASE	-	-	764	783	802	821
69UP04	ARM CHAIR, WIDE, POLY SEAT, PLASTIC BACK	-	-	845	866	887	908
69UP14	SIDE CHAIR, WIDE, POLY SEAT, PLASTIC BACK	-	-	845	866	887	908
69UP34	ARM CHAIR, WIDE, POLY SEAT, PLASTIC BACK, SLED BASE	-	-	1008	1033	1058	1084
69UP44	SIDE CHAIR, WIDE, POLY SEAT, PLASTIC BACK, SLED BASE	-	-	1008	1033	1058	1084
69UP01UB	ARM CHAIR, POLY SEAT, UPH BACK	.5 yd	-	671	688	705	721
69UP11UB	SIDE CHAIR, POLY SEAT, UPH BACK	.5 yd	-	671	688	705	721
69UP02UB	ARM CHAIR, POLY SEAT, UPH BACK, CASTERS	.5 yd	-	896	918	941	963
69UP31UB	ARM CHAIR, POLY SEAT, UPH BACK, SLED BASE	.5 yd	-	832	853	874	894
69UP41UB	SIDE CHAIR, POLY SEAT, UPH BACK, SLED BASE	.5 yd	-	832	853	874	894
69UP04UB	ARM CHAIR, WIDE, POLY SEAT, UPH BACK	.75 yd	-	969	993	1017	1042
69UP14UB	SIDE CHAIR, WIDE, POLY SEAT, UPH BACK	.75 yd	-	969	993	1017	1042
69UP34UB	ARM CHAIR, WIDE, POLY SEAT, UPH BACK, SLED BASE	.75 yd	-	1131	1159	1188	1216
69UP44UB	SIDE CHAIR, WIDE, POLY SEAT, UPH BACK, SLED BASE	.75 yd	-	1131	1159	1188	1216
69UP01US	ARM CHAIR, UPH SEAT, PLASTIC BACK	.5 yd	6	691	708	726	743
69UP11US	SIDE CHAIR, UPH SEAT, PLASTIC BACK	.5 yd	6	691	708	726	743
69UP02US	ARM CHAIR, UPH SEAT, PLASTIC BACK, CASTERS	.5 yd	6	919	942	965	988
69UP31US	ARM CHAIR, UPH SEAT, PLASTIC BACK, SLED BASE	.5 yd	6	854	875	897	918
69UP41US	SIDE CHAIR, UPH SEAT, PLASTIC BACK, SLED BASE	.5 yd	6	854	875	897	918
69UP01UP	ARM CHAIR, UPH SEAT, UPH BACK	1 yd	12	760	779	798	817
69UP11UP	SIDE CHAIR, UPH SEAT, UPH BACK	1 yd	12	760	779	798	817
69UP02UP	ARM CHAIR, UPH SEAT, UPH BACK, CASTERS	1 yd	12	980	1004	1029	1054
69UP31UP	ARM CHAIR, UPH SEAT, UPH BACK, SLED BASE	1 yd	12	922	945	968	991
69UP41UP	SIDE CHAIR, UPH SEAT, UPH BACK, SLED BASE	1 yd	12	922	945	968	991
69UP04US	ARM CHAIR, WIDE, UPH SEAT, PLASTIC BACK	.75 yd	9	887	909	931	954
69UP14US	SIDE CHAIR, WIDE, UPH SEAT, PLASTIC BACK	.75 yd	9	887	909	931	954
69UP34US	ARM CHAIR, WIDE, UPH SEAT, PLASTIC BACK, SLED BASE	.75 yd	9	1052	1078	1105	1131
69UP44US	SIDE CHAIR, WIDE, UPH SEAT, PLASTIC BACK, SLED BASE	.75 yd	9	1052	1078	1105	1131
69UP21UP	BAR STOOL WITH ARMS, UPH SEAT, UPH BACK	1 yd	12	966	990	1014	1038
69UP25UP	BAR STOOL, UPH SEAT, UPH BACK	1 yd	12	966	990	1014	1038
69UP25UB	BAR STOOL, POLY SEAT, UPH BACK	.5 yd	-	878	900	922	944
69UP21US	BAR STOOL WITH ARMS, UPH SEAT, PLASTIC BACK	.5 yd	6	898	920	943	965
69UP25US	BAR STOOL, UPH SEAT, PLASTIC BACK	.5 yd	6	898	920	943	965

## UPLAND OPTIONS

Product No	Description	Zones 1-4
-	WOOD BACK	156
-	WALL SAVER FRAME	35
-	UPLAND 1" EXTRA THICK SEAT FOAM	26
-	UPLAND 1" EXTRA THICK SEAT FOAM FOR UPH BACK AND WIDER	39
-	NICKEL PLATED GLIDE WITH NYLON CAP (PER SET)	60
-	UPLAND CLEAR GLIDES	39

Premium Fabric Grades	B	C	D	E	F	G	H	I	J	K	L
<b>Multiply by COM Ydg</b>	16	36	55	79	119	158	198	237	277	356	435

Available for an upcharge. List price per yard.

*\*eQuote is available for live configuration pricing. Contact customer service or sales representative with questions.*

# DINING CHAIRS

## UPLAND OPTIONS

Product No	Description	Zones 1-4			
-	SOFT CASTERS (FOR HARD SURFACE)	35			
69UP14RC	CORNER TABLE, MODULAR	556			
69UP14ST	SPACER TABLE, MODULAR	383			
69UP14MT	MINI SPACER TABLE, MODULAR	226			
69UP14ET	END TABLE, MODULAR	396			
69UP14CON	CONNECTING BAR GANGING	136			
69UP99	DOLLY, STANDARD	580	594	609	624
69UP99M	DOLLY, WIDE	831	852	873	893

## WEDGEWOOD

Product No	Description	COM Ydg	Moist. Barrier	Zone 1	Zone 2	Zone 3	Zone 4
7324004	CHAIR, WOOD ARM, LOW BACK	1.5 yd	\$18	2147	2201	2254	2308

Premium Fabric Grades	B	C	D	E	F	G	H	I	J	K	L
Multiply by COM Ydg	16	36	55	79	119	158	198	237	277	356	435
Available for an upcharge. List price per yard.											

\*eQuote is available for live configuration pricing. Contact customer service or sales representative with questions.

## BEDROOMS AND STORAGE

CAMDEN BEDS					
Product No	Description	Zone 1	Zone 2	Zone 3	Zone 4
9616420	RAISED BED, FULL	1390	1425	1460	1494
9616421	RAISED BED, TWIN	1167	1196	1225	1255
9616422	RAISED BED, TWIN XL	1259	1290	1322	1353
9616423	BED, TWIN	908	931	953	976
9616424	BED, TWIN XL	964	988	1012	1036
9616425	BED, FULL	1042	1068	1094	1120
9613318	METAL BED FRAME TWIN/FULL	176	180	185	189
9416211	CLASSIC CAPTAINS BED	3111	3189	3267	3344
9416212	CLASSIC CAPTAINS BED, XL	3214	3294	3375	3455
9416001	CLASSIC TWIN BED	1091	1118	1146	1173
9416002	CLASSIC TWIN BED, XL	1249	1280	1311	1343
9416203	CLASSIC LADDER END TWIN BED	867	889	910	932
9416204	CLASSIC LADDER END XL (NO BUNK	912	935	958	980
9416301	CLASSIC BUNK BED	2109	2162	2214	2267
9416302	CLASSIC BUNK BED, XL	2287	2344	2401	2459
9415514	CLASSIC 3 DRAWER UNDERBED UNIT	1734	1777	1821	1864
9415515	CLASSIC 3-DRAWER UNDERBED UNIT, XL	1864	1911	1957	2004
CLASSIC BEDS					
Product No	Description	Zone 1	Zone 2	Zone 3	Zone 4
9416211	CLASSIC CAPTAINS BED	3111	3189	3267	3344
9416212	CLASSIC CAPTAINS BED, XL	3214	3294	3375	3455
9416001	CLASSIC TWIN BED	1091	1118	1146	1173
9416002	CLASSIC TWIN BED, XL	1249	1280	1311	1343
9416203	CLASSIC LADDER END TWIN BED	867	889	910	932
9416204	CLASSIC LADDER END XL (NO BUNK	912	935	958	980
9416301	CLASSIC BUNK BED	2109	2162	2214	2267
9416302	CLASSIC BUNK BED, XL	2287	2344	2401	2459
9415514	CLASSIC 3 DRAWER UNDERBED UNIT	1734	1777	1821	1864
9415515	CLASSIC 3-DRAWER UNDERBED UNIT, XL	1864	1911	1957	2004
CLASSIC STORAGE					
Product No	Description	Zone 1	Zone 2	Zone 3	Zone 4
9435007	CLASSIC CHEST, 3-DRAWER	1780	1824	1869	1914
9435008	CLASSIC CHEST, 4-DRAWER	2176	2230	2285	2339
9435009	CLASSIC CHEST, 5-DRAWER	2633	2699	2765	2830
9444706	CLASSIC WARDROBE	3098	3175	3253	3330
9444707	CLASSIC WARDROBE WITH SHELVES	3829	3925	4020	4116
9444708	CLASSIC WARDROBE, SMALL	2197	2252	2307	2362
9435510	CLASSIC NIGHTSTAND	1036	1062	1088	1114
9485502	CLASSIC BEDSIDE TABLE	564	578	592	606

## BEDROOMS AND STORAGE

### DURASTAK

Product No	Description	Zone 1	Zone 2	Zone 3	Zone 4
9313680	JR. LOFT BED, TWIN XL	1556	1595	1634	1673
9313675	JR. LOFT BED, TWIN	1527	1565	1603	1642
9310080	LOFTING KIT, TWIN XL	1287	1319	1351	1384
9310075	LOFTING KIT, TWIN	1258	1289	1321	1352
9315480	JR. LOFT BED, FULL XL	1890	1937	1984	2032
9315475	JR. LOFT BED, FULL	1858	1904	1951	1997
9313600	JR. LOFT BED END, TWIN	643	659	675	691
9315400	JR. LOFT BED END, FULL	784	804	823	843

### ENDURE STORAGE

Product No	Description	Zone 1	Zone 2	Zone 3	Zone 4
9832024	CHEST, 2-DRAWER, 24"W	859	880	902	923
9832030	CHEST, 2-DRAWER, 30"W	964	988	1012	1036
9832036	CHEST, 2-DRAWER, 36"W	1069	1096	1122	1149
9833024	CHEST, 3-DRAWER, 24"W	1361	1395	1429	1463
9833030	CHEST, 3-DRAWER, 30"W	1497	1534	1572	1609
9833036	CHEST, 3-DRAWER, 36"W	1634	1675	1716	1757
9834024	CHEST, 4-DRAWER, 24"W	1691	1733	1776	1818
9834030	CHEST, 4-DRAWER, 30"W	1839	1885	1931	1977
9834036	CHEST, 4-DRAWER, 36"W	1986	2036	2085	2135
9835024	CHEST, 5-DRAWER, 24"W	2023	2074	2124	2175
9835030	CHEST, 5-DRAWER, 30"W	2180	2234	2289	2344
9835036	CHEST, 5-DRAWER, 36"W	2338	2396	2455	2513
9840318	WARDROBE, 18"W, 72"H	1337	1370	1404	1437
9840324	WARDROBE, 24"W, 72"H	1521	1559	1597	1635
9840336	WARDROBE, 36"W, 72"H	1705	1748	1790	1833
9841318	WARDROBE, 1-DRAWER, 18"W, 72"H	1679	1721	1763	1805
9841324	WARDROBE, 1-DRAWER, 24"W, 72"H	1863	1910	1956	2003
9841336	WARDROBE, 1-DRAWER, 36"W, 72"H	2046	2097	2148	2199
9842318	WARDROBE, 2-DRAWER, 18"W, 72"H	2021	2072	2122	2173
9842324	WARDROBE, 2-DRAWER, 24"W, 72"H	2204	2259	2314	2369
9842336	WARDROBE, 2-DRAWER, 36"W, 72"H	2388	2448	2507	2567
9932011	NIGHTSTAND, 2-DRAWER	1049	1075	1101	1128
9931012	NIGHTSTAND, DRAWER & DOOR	1081	1108	1135	1162
9931004	NIGHTSTAND, DRAWER & CUBBY	1026	1052	1077	1103
9920042	DESK, WRITING, SECURE DRAWER, 42"W	1159	1188	1217	1246

### FORGE BEDS

Product No	Description	Zone 1	Zone 2	Zone 3	Zone 4
9315290	BUNK BED, TWIN	2568	2632	2696	2761
9315291	BUNK BED, TWIN XL,	2427	2488	2548	2609
9315296	JR LOFT BED, TWIN, INCLUDES 2 ENDS, SPRING BASE	1233	1264	1295	1325
9315297	JR LOFT BED, TWIN XL INCLUDES 2 ENDS, XL SPRING BASE	1185	1215	1244	1274
9315200	JR LOFT BED END, TWIN	389	399	408	418

## BEDROOMS AND STORAGE

FUSION BEDS					
Product No	Description	Zone 1	Zone 2	Zone 3	Zone 4
9013811	BED, TWIN, REGULAR	1261	1293	1324	1356
9013812	BED, TWIN, XL	1366	1400	1434	1468
9015411	BED, FULL, REGULAR	1529	1567	1605	1644
9015412	BED, FULL, XL	1660	1702	1743	1784
9013810	HEAD PANEL, TWIN	550	564	578	591
9015410	HEAD PANEL, FULL	700	718	735	753
9013819	FOOTBOARD, TWIN	450	461	473	484
9015419	FOOTBOARD, FULL	550	564	578	591
FUSION BED OPTIONS					
Product No	Description	Zone 1	Zone 2	Zone 3	Zone 4
9013811	BED, TWIN, REGULAR	225	231	236	242
9013812	BED, TWIN, XL	350	359	368	376
9015411	BED, FULL, REGULAR	200	205	210	215
9015412	BED, FULL, XL	300	308	315	323
LENOX BEDS					
Product No	Description	Zone 1	Zone 2	Zone 3	Zone 4
9613831	LENOX BED, TWIN, REGULAR	1,082	1,109	1,136	1,163
9613832	LENOX BED, TWIN, XL	1,184	1,214	1,243	1,273
9615431	LENOX BED, FULL, REGULAR	1,229	1,260	1,291	1,321
9615432	LENOX BED, FULL, XL	1,357	1,391	1,424	1,458
9613830	LENOX HEADBOARD, TWIN	500	513	525	538
9615430	LENOX HEADBOARD, FULL	650	666	683	699
9613839	LENOX FOOTBOARD, TWIN	400	410	420	430
9615439	LENOX FOOTBOARD, FULL	500	513	525	538
LENOX BED OPTIONS					
Product No	Description	Zone 1	Zone 2	Zone 3	Zone 4
-	TWIN SPRINGBASE UPCHARGE	225	231	236	242
-	FULL SPRINGBASE UPCHARGE	350	359	368	376
-	TWIN HEADBOARD UPCHARGE	150	154	158	161
-	FULL HEADBOARD UPCHARGE	250	256	263	269
MASON BEDS					
Product No	Description	Zone 1	Zone 2	Zone 3	Zone 4
9613821	MASON BED, TWIN, REGULAR	1,082	1,109	1,136	1,163
9613822	MASON BED, TWIN, XL	1,184	1,214	1,243	1,273
9615421	MASON BED, FULL, REGULAR	1,229	1,260	1,291	1,321
9615422	MASON BED, FULL, XL	1,357	1,391	1,424	1,458
9613820	MASON HEADBOARD, TWIN	500	513	525	538
9615420	MASON HEADBOARD, FULL	650	666	683	699
9613829	MASON FOOTBOARD, TWIN	400	410	420	430
9615429	MASON FOOTBOARD, FULL	500	513	525	538

# BEDROOMS AND STORAGE

## MASON BED OPTIONS

Product No	Description	Zone 1	Zone 2	Zone 3	Zone 4
-	TWIN SPRINGBASE UPCHARGE	225	231	236	242
-	FULL SPRINGBASE UPCHARGE	350	359	368	376
-	TWIN HEADBOARD UPCHARGE	150	154	158	161
-	FULL HEADBOARD UPCHARGE	250	256	263	269

## LEGACY BEDS

Product No	Description	Zone 1	Zone 2	Zone 3	Zone 4
-	TWIN SPRINGBASE UPCHARGE	225	231	236	242
-	FULL SPRINGBASE UPCHARGE	350	359	368	376
-	TWIN HEADBOARD UPCHARGE	150	154	158	161
-	FULL HEADBOARD UPCHARGE	250	256	263	269

## LEGACY STORAGE

Product No	Description	Zone 1	Zone 2	Zone 3	Zone 4
<b>9535076</b>	LEGACY CHEST, 3-DRAWER	1769	1813	1857	1902
<b>9535077</b>	LEGACY CHEST, 4-DRAWER	2168	2222	2276	2331
<b>9535078</b>	LEGACY CHEST, 5-DRAWER	2622	2688	2753	2819
<b>9535536</b>	LEGACY NIGHTSTAND	1088	1115	1142	1170

## MERIT STORAGE

Product No	Description	Zone 1	Zone 2	Zone 3	Zone 4
<b>9832011</b>	NIGHTSTAND, 2-DRAWER	749	768	786	805
<b>9831012</b>	NIGHTSTAND, DRAWER & DOOR	772	791	811	830
<b>9831004</b>	NIGHTSTAND, DRAWER & CUBBY	733	751	770	788
<b>9832024</b>	CHEST, 2-DRAWER, 24"W	859	880	902	923
<b>9832030</b>	CHEST, 2-DRAWER, 30"W	964	988	1012	1036
<b>9832036</b>	CHEST, 2-DRAWER, 36"W	1069	1096	1122	1149
<b>9833024</b>	CHEST, 3-DRAWER, 24"W	1361	1395	1429	1463
<b>9833030</b>	CHEST, 3-DRAWER, 30"W	1497	1534	1572	1609
<b>9833036</b>	CHEST, 3-DRAWER, 36"W	1634	1675	1716	1757
<b>9834024</b>	CHEST, 4-DRAWER, 24"W	1691	1733	1776	1818
<b>9834030</b>	CHEST, 4-DRAWER, 30"W	1839	1885	1931	1977
<b>9834036</b>	CHEST, 4-DRAWER, 36"W	1986	2036	2085	2135
<b>9835024</b>	CHEST, 5-DRAWER, 24"W	2023	2074	2124	2175
<b>9835030</b>	CHEST, 5-DRAWER, 30"W	2180	2234	2289	2344
<b>9835036</b>	CHEST, 5-DRAWER, 36"W	2338	2396	2455	2513
<b>9840318</b>	WARDROBE, 18"W, 72"H	1337	1370	1404	1437
<b>9840324</b>	WARDROBE, 24"W, 72"H	1521	1559	1597	1635
<b>9840336</b>	WARDROBE, 36"W, 72"H	1705	1748	1790	1833
<b>9841318</b>	WARDROBE, 1-DRAWER, 18"W, 72"H	1679	1721	1763	1805
<b>9841324</b>	WARDROBE, 1-DRAWER, 24"W, 72"H	1863	1910	1956	2003
<b>9841336</b>	WARDROBE, 1-DRAWER, 36"W, 72"H	2046	2097	2148	2199
<b>9842318</b>	WARDROBE, 2-DRAWER, 18"W, 72"H	2021	2072	2122	2173
<b>9842324</b>	WARDROBE, 2-DRAWER, 24"W, 72"H	2204	2259	2314	2369
<b>9842336</b>	WARDROBE, 2-DRAWER, 36"W, 72"H	2388	2448	2507	2567

## BEDROOMS AND STORAGE

MERIT STORAGE					
Product No	Description	Zone 1	Zone 2	Zone 3	Zone 4
9820042	DESK, WRITING, 42"W	710	728	746	763
9821342	DESK, PEDESTAL, 3-DRAWER	1473	1510	1547	1583
9822342	DESK, PEDESTAL, 3-DRAWER, METAL LEG	1494	1531	1569	1606
MERIT DESK OPTIONS					
Product No	Description	Zones 1-4			
-	DESK PENCIL DRAWER	238			
-	PENCIL DRAWER EYEHOOK	32			
UNIVERSAL BED ACCESSORIES					
Product No	Description	Zone 1	Zone 2	Zone 3	Zone 4
9315290	BUNK BED, TWIN	2568	2632	2696	2761
9613745	GUARDRAIL, METAL	236	242	248	254
9616440	HEAD PANEL, METAL, TWIN	286	293	300	307
9616441	HEAD PANEL, METAL, FULL	352	361	370	378
9816434	HEAD PANEL, LAMINATE, TWIN	374	383	393	402
9816436	HEAD PANEL, LAMINATE, FULL	490	502	514	527
9618001	STRONG ARM SUPPORT WITH CENTER SUPPORT LEG, 3 PIECE, ADJUSTS FROM FULL TO KING	145	149	152	156
9618063	TWIN 75 SIDE RAIL STABILIZER BAR	244	250	256	262
9618064	STABILIZER BAR XL,SR,TWN 80 XL	268	275	281	288
MATTRESSES AND FOUNDATIONS					
Product No	Description	Zone 1	Zone 2	Zone 3	Zone 4
9656604	MATTRESS, DUAL FIRM ALL FOAM, TWIN, 36" X 75"	763	782	801	820
9656605	MATTRESS, DUAL FIRM ALL FOAM, TWIN XL, 36" X 80"	782	802	821	841
9656606	MATTRESS, DUAL FIRM ALL FOAM, TWIN 38" X 75"	817	837	858	878
9656607	MATTRESS, DUAL FIRM ALL FOAM, TWIN XL, 38" X 80"	838	859	880	901
9656684	MATTRESS, DUAL FIRM INNERSPRING, TWIN, 38" X 75" W/BBLUE NYL TCKING, INV SEAM, TB129, BOS IX-1	905	928	950	973
9656685	MATTRESS, DUAL FIRMING INNERSPRING, TWIN XL 38"X80" W/BBLUE NYL TCKNG, INV SEAM,TB129. BOX IX-2	889	911	933	956
9656686	MATTRESS, DUAL-FIRM INNERSPRING, FULL	1307	1340	1372	1405
9656687	MATTRESS, DUAL FIRM INNERSPRING, TWIN, 36"X75" W/BBLUE NYL TCKNG, INV SEAM, TB129 BOS IX-1	791	811	831	850
9656688	MATTRESS, DUAL FIRM INNERSPRING, TWIN XL W/BBLUE NYL TCKNG, INV SEAM, TB129 BOS IX-1	805	825	845	865
9658010	TWIN XP PLUS BLUE NYLON WOOD FOUNDATION	592	607	622	636
9658011	TWIN XL XP PLUS BLUE NYLON WOOD FOUNDATION	592	607	622	636
9658012	WOOD FOUNDATION, NYLON, FULL	592	607	622	636
MATTRESS AND BOX SPRING ENCASEMENTS					
Product No	Description	Zone 1	Zone 2	Zone 3	Zone 4
9656570	TWIN 6-9 MATTRESS/BOX SPRING ENCASEMENT	350	359	368	376
9656571	TWIN 6-9 MATTRESS/BOX SPRING ENCASEMENT XL	356	365	374	383
9656572	MATTRESS, BOX SPRING ENCASEMENT, FULL	380	390	399	408
BED PLATFORMS AND SPRING BASES					
Product No	Description	Zone 1	Zone 2	Zone 3	Zone 4
9618026	SPRING BASE, TWIN, ADJUSTABLE HOOK-IN, 36"X75"	449	460	471	483
9618027	SPRING BASE, TWIN XL, ADJUSTABLE HOOK-IN, 36"X 80"	482	494	506	518
9616600	BED PLATFORM, TWIN, 38"X 75	195	200	205	210

# BEHAVIORAL HEALTH

## BED PLATFORMS AND SPRING BASES

Product No	Description	Zone 1	Zone 2	Zone 3	Zone 4
9616601	BED PLATFORM, TWIN XL, 38"X 80	205	210	215	220
9616602	BED PLATFORM, FULL, 54X75	275	282	289	296
9616603	SEALED BED PLATFORM, TWIN XL, 38"X 79	365	374	383	392
9616608	TWIN 37 1/4 X 74 SEALED BED PLATFORM	327	335	343	352
9612501	BED PLATFORM, FULL, SEALED	400	410	420	430
9618061	SPRING BASE, TWIN, ADJUSTABLE HOOK-IN, 38" X 75"	616	631	647	662
9618062	SPRING BASE, TWIN XL, ADJUSTABLE HOOK-IN 38" X 80"	653	669	686	702

# BEHAVIORAL HEALTH

## CALVIN HD

Product No	Description	COM Ydg	Moist. Barrier	Zone 1	Zone 2	Zone 3	Zone 4
368101MHD	HEAVY DUTY CALVIN CHAIR	1.75	233	3243	3324	3405	3486
368101GHD	HEAVY DUTY CALVIN CHAIR, WIDE	3	369	4081	4183	4285	4387

## COOPER DWIGHT HD

Product No	Description	COM Ydg	Moist. Barrier	Zone 1	Zone 2	Zone 3	Zone 4
366101MLLHD	HEAVY DUTY COOPER DWIGHT CHAIR W/ SIDE PANELS LAMINATED	1.75	233	3214	3294	3375	3455
366101MULHD	HEAVY DUTY COOPER DWIGHT CHAIR W/ SIDE PANELS UPH OUTSIDE, LAMINATED INSIDE	2.5	233	3376	3460	3545	3629
366101MLUHD	HEAVY DUTY COOPER DWIGHT CHAIR W/ SIDE PANELS LAMINATED OUTSIDE, UPH INSIDE	2.5	233	3376	3460	3545	3629
366101MUUHD	HEAVY DUTY COOPER DWIGHT CHAIR W/ SIDE PANELS UPH	3.25	233	3489	3576	3663	3751

## COOPER DWIGHT HD OPTIONS

Product No	Description	Zones 1-4
-	FLOOR MOUNT KIT	89
-	WHITE NYLON CAP	34

## DINING HD

Product No	Description	COM Ydg	Moist. Barrier	Zone 1	Zone 2	Zone 3	Zone 4
361881HD	HEAVY DUTY ARM CHAIR, SLED BASE	1	67	1503	1541	1578	1616
361891HD	HEAVY DUTY SIDE CHAIR, SLED BASE	1	67	1413	1448	1484	1519

## DINING HD OPTIONS

Product No	Description	Zones 1-4
-	FLOOR MOUNT KIT	89
-	WHITE NYLON CAP	34
-	1" EXTRA SEAT FOAM	31

## DRUM, CUBE & OVAL HD

Product No	Description	Zone 1	Zone 2	Zone 3	Zone 4
3618D16HHD	HEAVY DUTY ROUND OCCASIONAL TABLE, 18" SQ, 16" HT	1763	1807	1851	1895
3618D18HHD	HEAVY DUTY ROUND OCCASIONAL TABLE, 18" SQ, 18" HT	1763	1807	1851	1895
3618D20HHD	HEAVY DUTY ROUND OCCASIONAL TABLE, 18" SQ, 20" HT	1763	1807	1851	1895
3618D22HHD	HEAVY DUTY ROUND OCCASIONAL TABLE, 18" SQ, 22" HT	1763	1807	1851	1895
3636D18HHD	HEAVY DUTY DRUM OCCASIONAL TABLE, 36" DIA, 18" HT	2620	2686	2751	2816
3618SQ16HHD	HEAVY DUTY CUBE OCCASIONAL TABLE, 18" SQ, 16" HT	1358	1392	1426	1460
3618SQ18HHD	HEAVY DUTY CUBE OCCASIONAL TABLE, 18" SQ, 18" HT	1358	1392	1426	1460
3618SQ20HHD	HEAVY DUTY CUBE OCCASIONAL TABLE, 18" SQ, 20" HT	1358	1392	1426	1460
3618SQ22HHD	HEAVY DUTY CUBE OCCASIONAL TABLE, 18" SQ, 22" HT	1358	1392	1426	1460
3636SQ18HHD	HEAVY DUTY CUBE OCCASIONAL TABLE, 36" SQ, 18" HT	2054	2105	2157	2208
363036OV16HHD	HEAVY DUTY OVAL OCCASIONAL TABLE, 30" X 36", 16"HT	3822	3918	4013	4109
363036OV18HHD	HEAVY DUTY OVAL OCCASIONAL TABLE, 30" X 36", 18"HT	3822	3918	4013	4109
363036OV20HHD	HEAVY DUTY OVAL OCCASIONAL TABLE, 30" X 36", 20"HT	3822	3918	4013	4109
363036OV22HHD	HEAVY DUTY OVAL OCCASIONAL TABLE, 30" X 36", 22"HT	3822	3918	4013	4109

# BEHAVIORAL HEALTH

## HARDI HD

Product No	Description	Zone 1	Zone 2	Zone 3	Zone 4
368809HD	HARDI CLUB CHAIR	1970	2019	2068	2118
368801HD	HARDI LOUNGE CHAIR, ARMLESS	1432	1468	1504	1539
368808HD	HARDI LOUNGE CHAIR, W/ARMS	1662	1704	1745	1787
368701HD	HARDI DINING CHAIR, ARMLESS	1329	1362	1395	1429
368708HD	HARDI DINING CHAIR, W/ARMS	1433	1469	1505	1540
368702HD	HARDI DINING CHAIR, CHILDRENS	1255	1286	1318	1349
368901HD	HARDI STOOL	948	972	995	1019
368840HD	HARDI ROCKER	2791	2861	2931	3000
368902HD	HARDI BED	5192	5322	5452	5581
368905HD	HARDI BEDSIDE TABLE	1753	1797	1841	1884
36HBM6	HD MATTRESS, 6" WITH VANDAL-RESISTANT, SEALED SEAM COVER	1836	1882	1928	1974

## HARDI HD OPTIONS

Product No	Description	Zones 1-4
-	FLOOR MOUNT KIT	118
-	SEAT CUSHION (368701HD)	446
-	SEAT CUSHION (368708HD)	446
-	SEAT CUSHION (368702HD)	421
-	SEAT CUSHION (368801HD)	480
-	SEAT CUSHION (368808HD)	480
-	SEAT CUSHION (368809HD)	480
-	SEAT CUSHION (368840HD)	492
-	SAND - INSTALLED - 50 LB	49
-	SAND - INSTALLED - 100 LB	99
-	SAND - INSTALLED - 150 LB	148
-	SAND - INSTALLED - 200 LB	198

## TAILOR HD

Product No	Description	COM Ydg	Moist. Barrier	Zone 1	Zone 2	Zone 3	Zone 4
369101MHD	HEAVY DUTY TAILOR CHAIR, ROTOMOLDED BASE	4.75	469	4102	4205	4307	4410
369101GHD	HEAVY DUTY TAILOR CHAIR, WIDE, ROTOMOLDED BASE	5.5	469	4908	5031	5153	5276
369102MHD	HEAVY DUTY TAILOR LOVESEAT, ROTOMOLDED BASE	7.5	594	5083	5210	5337	5464
369103MHD	HEAVY DUTY TAILOR SOFA, ROTOMOLDED BASE	10.25	719	8125	8328	8531	8734

## TAILOR HD OPTIONS

Product No	Description	Zones 1-4
-	ARM CAP URETHANE	479
-	FLOOR MOUNT KIT	162
-	FLOOR MOUNT KIT FOR BED	75
-	NICKEL PLATED GLIDE	48
-	SIDE CLEANOUT	201

# BEHAVIORAL HEALTH

<b>TRUMPET HD</b>					
<b>Product No</b>	<b>Description</b>	<b>Zone 1</b>	<b>Zone 2</b>	<b>Zone 3</b>	<b>Zone 4</b>
<b>3624DTR29HD</b>	HEAVY DUTY TRUMPET ROUND TABLE, 24" DIA, 29" HT	1912	1960	2008	2055
<b>3636DTR29HD</b>	HEAVY DUTY TRUMPET ROUND TABLE, 36" DIA, 29" HT	2347	2406	2464	2523
<b>3642DTR29HD</b>	HEAVY DUTY TRUMPET ROUND TABLE, 42" DIA, 29" HT	2959	3033	3107	3181
<b>3648DTR29HD</b>	HEAVY DUTY TRUMPET ROUND TABLE, 48" DIA, 29" HT	3011	3086	3162	3237
<b>1000 SERIES HD</b>					
<b>Product No</b>	<b>Description</b>	<b>Zone 1</b>	<b>Zone 2</b>	<b>Zone 3</b>	<b>Zone 4</b>
<b>361014HD</b>	HEAVY DUTY 1000 SERIES SIDE CHAIR, SLED BASE	2565	2629	2693	2757
<b>1000 SERIES HD OPTIONS</b>					
<b>Product No</b>	<b>Description</b>	<b>Zones 1-4</b>			
-	WHITE NYLON CAP	34			
-	FLOOR MOUNT GLIDE	101			

Butler Human Services®  
413-A Branchway Rd.  
North Chesterfield, Virginia 23236

877.852.0784  
butlerhumanservices.com

© 2025 Sauder Manufacturing Co. FOR INTERNAL USE ONLY.  
Butler Human Services believes the specifications in this price book to be correct at the time of printing. However, specifications, standard equipment, options, finishes and colors are subject to change without notice.

"Butler Human Services" is a registered trademark of Sauder Manufacturing Co.

BW01170316



Furniture  
**Price Book**



# 2026 Price Book Highlights

---

## NEW:

- Soul Mate Resin Overlay Option
- Hale Frame Color Options

## DISCONTINUED:

- Trace Wood Collection
- Trace Wood Underseat Panel
- Trace Wood Outer Back Panel
- Trace Wood Arm Cap Option
- Hale Wood Arm Cap Option
- Vantage Fully Upholstered Side & Arm Chairs
- Allay Sleep Sofa Plinth Base Option
- sleepToo Sleep Sofa Plinth Base Option
- Drip Guard on USB-A/USB-C Power option on Accord Recliner

## ADDITIONAL NOTES:

Minor changes have been made to the Terms & Conditions.  
The 2026 price increase goes into effect January 1, 2026.

# Contents

## GENERAL INFORMATION

2026 Price Book Highlights.....	1
Contents .....	2-3
Terms and Conditions .....	6-9
Warranty and Renewability .....	10-11
Ordering Information .....	14
Options Pricing Information .....	14
Quick Ship Program .....	15
Materials & Finishes.....	16
Materials & Finish Options.....	17-18
Order Checklist .....	19

## SEATING & COORDINATING TABLES

Accord™ .....	22-23
Accord™ Recliners .....	24
Accord™ Sleep Chair.....	25
Allay® .....	26
Allay® sleep sofas.....	27-28
Allay® Slim sleep sofas .....	29-30
Amari.....	31
Amari Recliners .....	32
Amigo Tables .....	33-35
Canton .....	36
Canton Arm Chairs .....	37-38
Canton Tables .....	39
Canton Modular Tables .....	40
Capital Gliders.....	41-43
Capital Sleep Chairs .....	44
Cove .....	45-46
Cove Patient Chairs .....	47
Cove Modular Seats .....	48
Cove Modular Arms.....	49
Cove Lounge .....	50
Cove Recliners .....	51
Cove Patient Recliners .....	52
Cove Orthopedic Recliners .....	53
Cove Sleep Recliners.....	54
Cove Orthopedic/Sleep Recliners.....	55
Cove Trendelenburg Recliners.....	56
Dune .....	56
Dune Occasional Tables .....	57-59
Hale.....	60
Hale Arm Chairs.....	61-62
Hale Benches .....	63
Hale Patient Chairs .....	64
Hale Motion Chairs.....	65
Hale Easy Access Chairs .....	66
Hale Modular Tables .....	67
Latitude .....	68
Latitude Chairs.....	69-70
Latitude Benches .....	70
Laurelwood .....	71

Laurelwood Patient & Motion.....	72
Laurelwood Bariatric .....	73
Laurelwood Bariatric Mid Back.....	74
Link .....	75-76
Monroe.....	77-79
Monroe Freestanding Tables.....	80
Monroe Modular Tables.....	81
Perk.....	82
PlyFold .....	83-84
PlyLok Upholstered Seat .....	85
PlyLok Wood Seat .....	86
PlyLok Bar Stools, Counter Stools .....	87
PlyLok Back Styles and Accessories .....	88
Pose Stools .....	89
Rally .....	90
Rally Aspire.....	91
Rally Embrace.....	92
Rally Indulge.....	93
Rally Compose.....	94
Rally Compose with Embrace .....	95
Rally Rise.....	96
Rally Unwind .....	97
Rally Armless Universal.....	98
Rally Ottomans & Tables.....	99-100
sleepToo® .....	101-102
sleepToo® Classic.....	103
sleepToo® Classic with Table .....	104
sleepToo® Custom.....	105
sleepToo® Custom with Table .....	106
Soul .....	107
Soul Mate .....	108
Soul Sofa .....	108
Sprout.....	109
Trace .....	110
Trace Metal Waiting & Motion.....	111
Trace Metal Patient & Motion.....	112
Trace Easy Access Chairs.....	113
Trace Tables.....	114
Upland .....	115
Upland Poly Seat/Plastic Back.....	116
Upland Poly Seat/Plastic Back.....	117
Upland Poly Seat/Uph Back .....	118
Upland Poly Seat/Uph Back .....	119
Upland Uph Seat/Plastic Back .....	120
Upland Uph Seat/Plastic Back .....	121
Upland Uph Seat/Uph Back.....	122
Upland Uph Seat/Uph Back.....	123
Upland Easy Access Poly Seat.....	124
Upland Easy Access Uph Seat .....	125
Upland Poly Seat/Plastic Back Bar Stools .....	126
Upland Poly Seat/Uph Back Bar Stools.....	127

# Contents

---

Upland Uph Seat/Plastic Back Bar Stools .....	128
Upland Uph Seat/Uph Back Bar Stools .....	129
Upland Tables.....	130
Versant Glider .....	131-134
Versant Sleep Chairs .....	135-136
Wedgewood .....	137-138
Wedgewood Bariatric .....	139-140

## **TABLES**

---

4700 Series Occasional Tables .....	143
Drum & Cube Occasional Tables .....	144
Fuse Occasional Tables.....	145
Trumpet & Disc Occasional Tables.....	146
Fuse Multi-purpose Tables .....	147
Trumpet & Disc Multi-purpose Tables .....	148
Tubular Multi-purpose Tables .....	149-151
Tubular Tables Accessories .....	152

## **TASK CHAIRS**

---

Delta.....	155-158
Trey®-G.....	159

## **CHAPEL FURNITURE**

---

Vantage .....	162
Vantage SE .....	163
Vantage Accessories .....	164
Oaklok .....	165
Oaklok Accessories .....	166-167
Unity®.....	168-170
Unity® Accessories.....	171-172
Chancel .....	173-175
Additional Chapel Product Accessories.....	176-177



Terms and Conditions  
Warranty

# Terms and Conditions

## CONTACT INFORMATION

Please contact Wieland with questions or for assistance.

Wieland  
10785 Rose Avenue  
New Haven, IN 46774-9246  
Phone 888.943.5263 | Fax 260.627.6496  
wielandhealthcare.com | sales@wielandhealthcare.com

Wieland is a brand of Sauder® Manufacturing Co.

## DEFINITIONS

Company means Sauder® Manufacturing Co., its servants, employees, and agents and includes Sauder® Manufacturing Co; Sauder Worship Seating®; Sauder Education®; Sauder® Courtroom Furniture; Wieland; Butler Human Services®, Sauder Courtroom Seating®; and any affiliated, predecessor or successor entities.

## GENERAL TERMS

### EXCLUSIVE CONTRACT TERMS

These Terms and Conditions shall be deemed incorporated as a part of every contract to purchase goods from the Company. By entering into a purchase contract with the Company and accepting delivery of the goods, Purchaser agrees that these Terms and Conditions are the sole and exclusive statement of all such terms and conditions, that the contract is limited to these terms and conditions, and that any different or additional terms and conditions proposed by Purchaser are objected to and shall not become a part of the contract unless expressly accepted by Company in writing.

### AUTHORIZED DEALERS

Possession of these terms and conditions, product information and/or price list does not imply the right to purchase products illustrated and priced therein. Sales are confined to accounts with credit approval only. A minimum of 30 percent down payment is required on all orders until credit is established.

### APPLICABLE LAW

The Contract shall be governed by the substantive laws of the State of Ohio. The sole and exclusive jurisdiction and venue for the enforcement or any rights or obligations relating to the contract or the goods shall be in the Fulton County, Ohio Court of Common Pleas or the United States District Court for the Northern District of Ohio, and the parties consent to the jurisdiction of these courts as a part of this transaction. The Company shall be entitled to recover its reasonable attorney's fees, costs and expenses in connection with any action taken by Company to enforce the contract (including these Terms and Conditions).

### GOVERNMENT REGULATIONS

Customer shall comply with all applicable governmental laws, codes, and regulations, including building and fire codes applicable to this purchase and including design, type of material and installation arrangements thereof.

## PRICES & PAYMENT TERMS

### PRICES

Published prices are list, FOB destination, per zone destination. Prices do not account for special delivery situations including the following, which are the responsibility of the Purchaser:

- Dedicated delivery appointments
- Lift gate
- Multiple drops on site per shipment

- Multiple shipments per order (that could be accommodated by one delivery)
- Charges for cartons, packaging, and crating, beyond the normal Company shipping methods
- Storage or insurance claims
- Sales and other taxes
- Local delivery, uncrating, and installation (if applicable)

Prices on Order Acknowledgements are net. Company reserves the right to change prices prior to Order Acknowledgement without notice. Company reserves the right to increase prices or any part thereof, if Purchaser delays delivery of the furniture beyond 8 weeks from receipt of any of the following: Order Acknowledgment, signed order contract, receipt of subcontract, and/or receipt of signed purchase order.

In addition to any other right of Company to increase prices as set forth herein, in the event Purchaser, for any reason, directs delivery of goods and services ordered to occur beyond 8 weeks from receipt of any of the following: Order Acknowledgment, signed order contract, receipt of subcontract, and/or receipt of signed purchase order, Purchaser shall bear the risk of and be responsible to pay Company any price increases that may occur in connection with the goods and services ordered as well as storage costs arising from or incurred as a result of same. Company reserves the right to require a non-refundable deposit be paid by Purchaser to Company in the event of the foregoing.

### PERFORMANCE BONDS

If a bond is required, the cost shall be 1% of the total Contract. If a bond is not specifically listed on the Contract it is not included. If a bond is purchased, the bond will only cover substantial completion of the project plus one year of the warranty period.

### TAXES

All sales are subject to sales tax unless a valid sales tax exemption certificate or resale certificate for the ship-to state accompanies the order.

### INVOICING

Product will be invoiced at the time of shipment, or as designated by the Order Acknowledgment. If a partial order is shipped and a back order is created, Purchaser will be invoiced for the portion that shipped.

### TERMS OF PAYMENT, SECURITY INTEREST AND LIEN RIGHTS

Credit will be established based upon Company's determination of credit worthiness. A deposit or prepayment may be required on certain accounts after credit review. Credit terms are 30 days net from date of invoice and/or as designated by the Order Acknowledgment. Company may cancel or change credit terms at its discretion and may request advance payment at any time. No order will be released for production without a credit approval from the Credit Department. Company may at its option, and without notice, raise or allow charges in excess of any credit limit granted. Purchaser understands and agrees that (the Purchaser) is responsible for all charges on the account. All payments due to Company shall be paid without any set-off or claim.

Purchaser agrees to pay a service charge of 1.5 percent per month or as allowed by law on all past due accounts. A past due account is an account that remains unpaid for more than 30 days. Until such time that an account and/or an order is paid in full to the Company, Company shall retain a security interest in and lien on all materials, merchandise, furnishings, and/or goods manufactured, provided, delivered or otherwise on said account and/or order. Company reserves and may exercise any and all rights and remedies

Initials \_\_\_\_\_ Date \_\_\_\_\_

# Terms and Conditions

---

with respect to said materials, merchandise, furnishings, and/or goods against the Customer and/or any individual or entity in possession of or claiming an interest in said materials, merchandise, furnishings and/or goods, including but not limited to demanding assembly of the goods at the direction of Company, re-taking possession and selling and applying proceeds of any sale toward the account, and/or filing suit. All charges are payable according to these terms and conditions unless otherwise prearranged and agreed to in writing by Company.

## TITLE & RISK

Title to all goods shall pass from Company to Purchaser upon Company's receipt of payment in full under this Contract or any change thereof. Risk of loss or damage to the goods becomes the responsibility of Purchaser upon delivery. Unless otherwise specified in writing, Company will determine the method of shipment and carrier. If products are shipped via Purchaser's choice of carrier, Company is not responsible for damage in shipment.

Purchaser will insure the goods against all insurable risks in the name of Purchaser and also in the name of Sauder Manufacturing Co. as the unpaid vendor for their full insurable value.

## ORDERING & LEAD TIME

---

### ORDERING

A signed purchase order or contract received via mail, fax or email is required before an order is processed. In addition, credit applications, credit references and/or advance payments may be required for newly established accounts. Orders are not scheduled in production, nor materials purchased, until all details are received.

### ORDER ACKNOWLEDGMENT

Orders are binding upon receipt of the Order Acknowledgement. The Order Acknowledgement, which relates to the acceptance of the order/contract, is sent after the order/contract contemplates pricing changes, if any, delivery dates and/or estimated installation completion. Any and all modifications to the Order Acknowledgement must be reconfirmed and signed by Company.

Acceptance of the Order Acknowledgement shall be evidenced by signature(s) and/or Company commencing work on the project.

Any error or discrepancy on the Order Acknowledgement must be reported to Company in writing with 3 working days from the receipt of the Order Acknowledgement. Cashing a down payment check does not constitute acceptance.

### CHANGE ORDERS

The order as shown on the Order Acknowledgement can be modified only by a written communication or reconfirmation signed by Company and Purchaser.

Company may, at its discretion, accept reasonable change orders with the following conditions:

- The request for change must be submitted in writing and received before order specific parts have been purchased and/or the manufacturing process has begun.
- Changes may be subject to additional charges for material, labor, restocking, and administrative costs.
- Changes may result in an extended delivery date.

### CANCELLATIONS

Any deposit made with respect to the order is non-refundable. Company reserves the right to cancel any order, with notice to Purchaser, due to breach of obligation or contract. Additionally, if an order is cancelled after order specific materials have been purchased and/or production has started,

Purchaser will be responsible for the cost associated with those materials or production. Any Customer's Own Material (COM) supplied will be returned "as-is". This applies to any fabric that has been cut, wood parts with a finish applied, and all laminates. A cancellation or restocking charge of 1/3 of the net sale is applicable on orders cancelled.

### LEAD TIME

Lead times will vary based on specifications chosen and available manufacturing capacity. Consult your authorized sales representative or the home office when placing your order to determine estimated ship date.

### DRAWINGS

The drawing(s) are a key component in determining final quantities and layouts for goods requiring installation. The Final Signed Drawing shall be considered a legal and binding part of the Contract. Changes to the Final Signed Drawing can only be made through written communication to Company or reconfirmation signed by Company and Purchaser. Changes requested may incur additional costs and/or delivery delays.

### CUSTOM PRODUCTS AND MATERIALS

All nonstandard designs and materials are subject to a surcharge; contact Company for approval and pricing. The use of nonstandard designs and/or materials may cause extended delivery times and reduced warranty coverage.

- Within our standard offering, an upcharge may be applied if a premium pattern or finish is selected. This may also cause extended lead times.

### CUSTOMER'S OWN MATERIAL (COM)

Please contact Company on all COM fabrics. A sample of the COM fabric is required to be submitted to Company for approval and yardage estimate prior to placing an order. The sample should be large enough to indicate a repeat if applicable.

Yardage requirements will be calculated based on a variety of factors including roll width, pattern matching and direction. If a fabric is directional, it will be applied vertically unless specific instructions are given to the contrary. If a horizontal application is desired, please inform Company as additional yardage or special production techniques may be required. At Purchaser's request, Company may, in its discretion, for non-Company program fabrics handle the purchase of the COM fabric for a charge of 20 percent of the fabric list price.

Company reserves the right of preliminary approval for all COM prior to order acceptance. Even after such preliminary approval, Company reserves the right to reject COM if, upon physical inspection of the material, it proves unacceptable for use on Company products. When COM is accepted, Company assumes no responsibility for appearance, durability, color fastness, or any other quality after it is upholstered on a Company product.

Orders with COM are not scheduled into production until all materials are received and inspected. If partial shipment entry is required, indicate on purchase order, or forward orders with standard products and COM products on separate purchase orders. Shipping address:

Sauder Manufacturing Co.  
C/O Wieland  
10785 Rose Avenue  
New Haven, IN 46774-9246

Initials \_\_\_\_\_ Date \_\_\_\_\_

# Terms and Conditions

## PRODUCT DESIGN, COMPLIANCE & SAFETY

### PRODUCT DESIGN

Company reserves the right to make changes in design and construction or discontinue products without prior notice.

### COMPLIANCE

Products offered by Company do comply with the requirements of local, state and national fire codes. The products offered as a base are manufactured with resilient filling materials and textiles in compliance with California Technical Bulletin TB117-2013.

However, any verification of compliance of COM materials with TB117-2013 is the responsibility of the person specifying the COM material.

### THE TOXIC SUBSTANCES CONTROL ACT

Enforced by the EPS, TSCA a law enacted in 1976 regulates chemical substances and mixtures in commerce. Products offered comply with all applicable rules or orders under the TSCA, and no chemical substances in violation of the TSCA are offered.



### GREENGUARD® CERTIFICATION

Company has achieved Greenguard certification on all products and Greenguard Gold on many. Please reference [Wielandhealthcare.com](http://Wielandhealthcare.com) for product specific information. GREENGUARD certified products are certified to meet GREENGUARD standards for low chemical emissions into indoor air during product usage. For more information, visit <https://spot.ulprospector.com/en/na/Builtenvironment> or contact Company for a complete list of all our certified products.



### BIFMA

Sauder Manufacturing Co. is proud to demonstrate a commitment to the environment, and to both the quality and performance of products through BIFMA e3 LEVEL testing and certification. Learn more about BIFMA Certification at [levelcertified.org](http://levelcertified.org).

### BIFMA

Company does not warrant that row identification lighting for Auditorium Seating supplied by Company is suitable for illuminating stairs and/or trip hazards. Purchaser acknowledges that it will indemnify Company against any claims that may be made against it, arising out of Purchaser's reliance upon row identification lighting for illuminating stairs and/or trip hazards.

## FREIGHT & DELIVERY

### FREIGHT

Unless otherwise arranged in writing, all Company shipments are made on a site-to-site basis (back of trailer). Unless otherwise specified in writing, we will determine the method of shipment and carrier. All weights and dimensions provided in product literature are approximate. See map below for zone identification within the continental United States. [Contact your authorized sales representative for pricing in Alaska, Hawaii and outside the United States.]

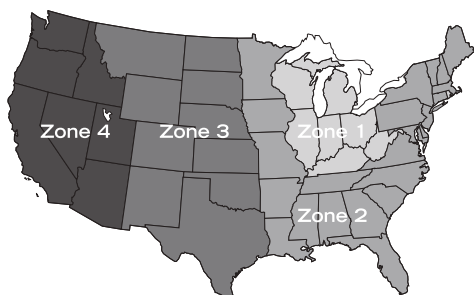

## MINIMUM SHIPPING AND HANDLING CHARGE

Orders that weigh less than 200 lb. will require an additional shipping and handling charge. See the chart to determine the net charge based on total order weight.

	0-10 lbs	11-20 lbs	21-50 lbs	51-100 lbs	101-199 lbs
<b>ZONE 1</b>	<b>\$50</b>	<b>\$70</b>	<b>\$80</b>	<b>\$100</b>	<b>\$130</b>
<b>ZONE 2</b>	<b>\$55</b>	<b>\$80</b>	<b>\$100</b>	<b>\$125</b>	<b>\$150</b>
<b>ZONE 3</b>	<b>\$60</b>	<b>\$90</b>	<b>\$120</b>	<b>\$150</b>	<b>\$175</b>
<b>ZONE 4</b>	<b>\$70</b>	<b>\$100</b>	<b>\$140</b>	<b>\$175</b>	<b>\$200</b>

Shipping and handling prices are net.

## BUILDING ACCESS

Facilities must be ready to receive furniture. All construction must be complete before we can start delivery and installation. There must be free and clear easy access to the building where the furniture will be installed. Rooms, hallways, lobby, and entrance way must be empty and free and clear of all obstructions. All buildings with 3 or more floors must have working elevators free and clear of all obstructions and dedicated for the sole use of our installers during our installation. If upon arrival for delivery and installation, the conditions described in this paragraph are not met, the installation will not be started.

## DELAYED DELIVERY

Company reserves the right to increase prices or any part thereof, if Purchaser delays delivery of the furniture beyond 8 weeks from receipt of any of the following: Order Acknowledgment, signed order contract, receipt of subcontract, and/or receipt of signed purchase order. Purchaser agrees not to use the Goods described on the order until the full purchase price is paid to the Company.

In addition to any other right of Company to increase prices as set forth herein, in the event Purchaser, for any reason, directs delivery of goods and services ordered to occur beyond 8 weeks from receipt of any of the following: Order Acknowledgment, signed order contract, receipt of subcontract, and/or receipt of signed purchase order, Purchaser shall bear the risk of and be responsible to pay Company any price increases that may occur in connection with the goods and services ordered as well as storage costs arising from or incurred as a result of same. Company reserves the right to require a non-refundable deposit be paid by Purchaser to Company in the event of the foregoing.

## DELIVERY

Company shall not be liable for delays in delivery of furniture caused by fire, strikes, weather or from causes beyond its control.

## SPECIAL DELIVERY CHARGES

Request to Carton	<b>\$20 per unit</b>
Delivery Appointment	<b>\$400</b>
Inside Delivery	<b>\$150 plus \$50/unit</b>
Lift Gate Required	<b>\$2,500</b>
Multiple Stops	<b>\$250 per stop</b>
Box Truck Required*	<b>\$1200</b>

\*Required if 53' semi truck is too large to access dock.

Above prices are net.

An on-site delivery date will be established once all details needed for production and installation (if applicable) have been received. Delivery of Goods may be separate from commencement of installation.

Initials \_\_\_\_\_ Date \_\_\_\_\_

# Terms and Conditions

---

The delivery price submitted is based on the understanding that there shall be appropriate access to the site free of any hindrance whatsoever, timely access to the site and adequate space to unload the Goods. In the event that the site is not fully ready as described previously at the time of delivery, Company reserves the right to charge and collect additional fees to cover any additional costs incurred. These charges include but not limited to the following: delivery appointment, consolidation of shipment, lift gate, multiple stops, special packaging, dedicated truck, expedited shipment, greater than two hour unload time, box truck required, residential shipment.

The goods may arrive in cardboard boxes. Unless otherwise specified, it is the Purchaser's responsibility to arrange for the disposal of the boxes.

## STORAGE FEES

If Goods are ready for shipment according to the terms of the Order Acknowledgment or subsequent change order, and Customer cannot receive as stated, the Goods may, at our discretion, be shipped to storage facilities, or put in storage at Purchaser's expense. Company reserves the right to deny storage of the Goods due to lack of available space. Storage fees are 5% of purchase price per month. These charges can, at Company's option, be added to the order total amount due or invoiced separately. Storage fees are considered change orders. See CHANGE ORDER SECTION requirements. All storage fees are required to be paid in full before ship. All risk of damage, destruction, theft or loss while in storage shall be the responsibility of Purchaser.

## INSTALLATION

Purchaser accepts responsibility for the safety of all persons except Company representatives on the premises where Company performs delivery and/or installation and, accordingly, Purchaser shall also defend and save Company harmless from all claims from persons injured on the premises where delivery and/or installation is performed.

The installation contract price is based upon full building and location access and readiness for installation to begin upon on-site delivery. The space must be climate controlled, not affect by outside weather conditions, permanent utilities must be operational and carpet and/or any flooring must be complete. In addition, any of the other contractors must not interfere with the unloading, staging or installation process including any overhead electrical, lighting or painting projects or any other work that would interfere with the placement of the furniture into its permanent locations. Failure to have the site ready for installation may result in additional cost to the Purchaser not previously shown on the contract. These additional costs may include, but are not limited to, additional handling charges, insurance, down-time (which includes additional labor, lodging and meals), and/or any other proper expense incurred by the Company. If site conditions cause a substantial delay, the installer may leave the job site, installation will be rescheduled and Purchaser will be responsible for the return fee for the installation crew.

## RETURNS & CLAIMS

### RETURNS

No merchandise may be returned to Company without prior written consent from Company, and any returns must be in accordance Company's shipping instructions. If approved, returns for reasons other than valid warranty claims will be subject to shipping and handling charges, and must be made, FOB the Company. In addition, restoration and restocking charges may be charged to Purchaser.

### DAMAGE CLAIMS

Freight terms are F.O.B. destination. Risk of loss, damage or destruction from and after delivery is the responsibility of Purchaser, it being agreed and

understood that loss, damage or destruction of goods from and after delivery does not relieve Purchaser of its payment obligations to Company.

Purchaser is advised to inspect the shipment and note any damage on the bill of lading. Notification of damage discovered after delivery must be given to Company within 10 days immediately following delivery.

When products are shipped via Purchaser's choice of carrier, Company is not responsible for damage in shipment. Purchaser should carefully inspect all items at time of delivery and note any obvious damage on the delivery receipt. For Purchaser's protection, such obvious or subsequently discovered concealed damage must be reported in writing to the carrier in accordance with applicable regulations and time limits. Company does not assume any responsibility for damage that occurs during storage.

## OTHER CLAIMS

All claims against Company other than valid warranty claims, including claims for shortages and errors, must be made in writing within 10 days after delivery. The facts on which the claim is based must be directed in writing to the Warranty Service Coordinator. Failure to make any such claim against terms and conditions to Company within such 10-day period shall constitute acceptance of the merchandise and waiver of any such shortages, errors, or other claims of any type or nature. The cost of field repairs or adjustments performed by any non-Company personnel will not be reimbursed unless previously authorized in writing by Company.

## CONSEQUENTIAL LOSS

Under no circumstances shall Company be liable to any party hereto or any third-party for any special, indirect, punitive, incidental or consequential damages or loss (including lost profits, loss of use, damage to goodwill or loss of business) in connection with or in any way related to the agreement between the parties.

## FORCE MAJEURE AND OTHER MATTERS BEYOND COMPANY'S CONTROL

Company is not liable for failure to perform or delay in performance or delivery due to cancellation or postponement or deemed in breach of the Agreement (or PO if using Purchase Order) based on circumstances resulting from any cause beyond either parties control including, but not limited to, federal or state governmental orders or lack thereof, legislation, regulations, labor strikes, accidents, epidemic, pandemic, immediate threat of mass casualties or contagious illness or disease, act of war, riot, mass shooting, terrorism, acts of God, fires, severe weather conditions, floods, curtailment of transportation and or supply chain, inability to secure materials, electrical failure or any event that prohibits attendees being able to attend the event. Parties agree to minimize the damage of the Force Majeure Event to fullest extent possible. Notices shall state the nature of the Force Majeure Event, actions the party wishes to take, and if applicable a plan to mitigate any delays caused by the event. Such notice shall not subject either party to any penalties, liquidated damages, or forfeiture of any pre or post payment. Company reserves the right to modify order pricing and/or product offerings at any time based on material cost increases, supplier cost increases, economic fluctuations, supply chain issues and/or other issues related to the foregoing. All orders may be subject to an increase in prices or any part thereof, and such other charges as set forth herein if Purchaser delays delivery of the furniture beyond 8 weeks from receipt of any of the following: Order Acknowledgment, signed order contract, receipt of subcontract, and/or receipt of signed purchase order.

Signature \_\_\_\_\_ Title \_\_\_\_\_ Date \_\_\_\_\_

# Warranty and Renewability

Sauder® Manufacturing Co. ("Company") provides the following warranty to the end-user and owner ("Owner") of the new Wieland Healthcare products ("Products"). All Wieland Healthcare products are warranted to be of good quality and free from defects in material and workmanship under normal use for the periods noted below.

This warranty information covers the structure of the furniture: the laminated-veneer or solid wood frame, the construction of the arms, table legs and stretchers, delamination of tables, and all fasteners and moving parts.

Years under Warranty – Structure							renewability	
Seating	1	2	3	5	10	25	full	component
Accord™						X	X	
Allay®						X	X	
Amari						X	X	
Canton						X		X
Capital						X	X	
Chancel						X		X
Cove						X	X	
Delta					X			X
Hale						X		X
Latitude						X	X	
Laurelwood					X			X
Link					X			X
Monroe						X		X
Oaklok					X			X
Perk					X			X
Plyfold					X			X
Plylok						X		X
Pose					X			X
Rally						X	X	
sleepToo®						X	X	
Soul						X		X
Sprout						X		X
Trace						X		X
Trey®-G					X			X
Unity					X			X
Upland					X			X
Vantage					X			X
Versant						X	X	
Wedgewood					X			X
Years under Warranty – Structure							renewability	
Tables	1	2	3	5	10	25	full	component
4700 Series						X		X
Amigo						X		X
Canton						X		
Cube						X		
Disc						X		X
Drum						X		
Dune					X			
Fuse						X		
Trumpet						X		X
Tubular						X		X

Years under Warranty – Structure						
Accessory	1	2	3	5	10	25
Accord™ intelliTrac™					X	
Accord™ Recline Mech					X	
Accord™ safeBrake					X	
Accord™ Sleep Chair Mech					X	
Accord™ Transfer Arm					X	
Allay® Ottoman Mech					X	
Allay® Drawer Slides		X				
Amari Brakes			X			
Amari Recliner Mech					X	
Amari Transfer Arm					X	
Capital Sleep Chair Mech					X	
Cove Brakes			X			
Cove Recliner Mech					X	
Cove Transfer Arm					X	
Glider Mech					X	
SmartRail					X	
Power Unit - 120V/USB				X		
Power Unit - USB-A/C				X		
Pneumatic Cylinder				X		
sleepToo® Drawer Slides		X				
sleepToo® Ottoman Mech					X	
sleepToo® Nylon Back Fabric				X		
sleepToo® Table and Table Mech					X	
Tablet Arms, Casters and Brakes			X			
Heat + Massage				X		

## Fabric:

The Company warrants Wieland Program Fabrics, if purchased through Wieland for use on Wieland products for a period of 5 years.

Company has assembled an extensive graded-in offering featuring a wide selection of upholstery selected for performance. Wieland Program fabrics are available through ArcCom, Architex, Maharam, Mayer, Momentum, and CF Stinson. Company warrants these textiles to perform under normal conditions as furniture upholstery and when cared for according to cleaning and maintenance guidelines provided by the textile supplier. Proper care and cleaning is imperative for maximizing textile performance. However, in the unlikely event that one of these upholsteries does not perform in accordance with manufacturing specifications when used and maintained under normal conditions, and the user has not misused, cleaned or attempted to clean using cleaning agents or procedures not suggested or approved by the textile supplier, Company will replace the fabric free of charge.

## Exclusions & Conditions:

The following are specially excluded from the warranty:

1. Any custom components that are not a part of the company standard line. This would include, but not be limited to, custom-designed parts or customer specified components, such as fabric, vinyl, foam, etc., that are not a part of the standard company product line.
2. Improper operation or abuse, alteration, modification or misuse of Products.
3. Damage caused by Products being unduly subjected to water or damaged by U.V. rays (damage caused by ultra violet light from direct,

continued on next page

# Warranty and Renewability

---

- indirect or diffuse sunlight or artificial lighting sources).
4. Damage caused in storing/moving products or furniture after delivery and prior to installation – when stored at customer request.
  5. Damage caused by on-site construction process, other contractors or subcontractors, or the work of such contractors or subcontractors, including drywall dust.
  6. Damage as the result of accident, fire, flood, civil disorder, strike, Acts of God, abuse, misuse or any cause outside of ordinary usage.
  7. Normal wear and tear, maintenance, scratching or natural wearing of finishes on chairs and tables.
  8. Damage to the underlying facility or property, including normal wear and tear to floors from chairs
  9. Differences or variances in color from sample material (except within commercially reasonable tolerances) to actual product, nor matching fabrics on separate orders.
  10. Fabric damage caused by stain, vacuuming or improper cleaning.  
(Note: Not all Fabrics are standard with stain repellent treatment)
  11. Damage caused from shipping.

## General Information:

- A. We have agreements with our upholstery suppliers to assure that all products meet Association of Contract Textiles standards for bow and skew. We also further eliminate pattern variability in our cutting process. However, you may still notice some irregularities that are within industry standards and are not covered under our product warranty.
- B. Replacement, repair, or refund of the purchase price, (pro-rated for use), as determined by Company and is the "sole and exclusive" remedy under the warranty, and all incidental and consequential damages are excluded and disclaimed from warranty coverage.
- C. To receive benefits under the terms of this warranty, the purchaser must:
  1. Notify Company of the defect.
  2. Fill out Company service request form, which will be sent to you, and provide a description of the defect.
  3. Submit completed form along with applicable photos.
- D. Any disputes over the provisions of this warranty will be mutually reviewed by representatives of Purchaser and Company.

**E. ALL IMPLIED WARRANTIES, INCLUDING ANY WARRANTIES OF MERCHANTABILITY OR FITNESS FOR A PARTICULAR PURPOSE ARE EXCLUDED AND DISCLAIMED. THIS LIMITED WARRANTY IS THE ONLY WARRANTY FROM COMPANY APPLICABLE TO THE GOODS.**

## TYPES OF RENEWABILITY

---

**Fully Renewable:** These products have replaceable covers with hook and loop upholstery attachment and most components are replaceable as well

**Component Replaceable:** Entire seat cushions (wood/foam/upholstery) and back cushions (wood/foam/upholstery) are replaceable. Additional replaceable components may vary per product. Additional component examples: Arms, tops, foot or casters, arm or back caps, handles, drawers or doors, etc.

See Chart for product details.



# Ordering Information

# Ordering Information

## DIMENSIONS AND WEIGHTS

The dimensions and weights used throughout all of Company materials are approximate. The Price Book contains the most accurate information. If you are working on a specification which calls for close tolerances, please call the home office for the precise measurements.

## FABRIC ZONES

Fabric zoning (using different fabrics for seat, back, etc.) is available without an additional charge. When multiple fabric grades are selected, unit price is based on the highest fabric grade selected. Zoning worksheets must be submitted for lounge products. A maximum of three different fabrics may be selected per unit.

## FABRIC GRADES

Fabric pricing for patterns greater than J are available from your representative by quote.

## STACK CHAIRS

Many of the products are stacking. Please refer to the notes for details or contact customer service for additional information.

## CUSTOM HEIGHT CHAIRS

*Chairs:* Available on any 4-leg chair and ottoman. Not available on sledbase chairs. Maximum cut-off is 2 inches.

## LEFT VS. RIGHT SPECIFICATIONS

Specify left- or right- when facing the front of the chair, unless otherwise specified.

## LASER CUT AND LASER CUT WITH COLOR FILL

The Company offers a unique and distinctive way to personalize and identify a facility's chairs with a laser cut of its logo or seal on the back and/or front of any all-wood chair or back of a wood back chair with upholstered front. Simply provide your company sales representative with the desired location, a digital file (TIF, GIF or JPG) and the finish size (standard sizes are 2.5" x 4.5" or 4.25" diameter; non-standard sizes are available at an additional charge).

# Options Pricing Information

## ADDITIONAL OPTIONS PRICING





Specify any of this at the time of ordering.

\$1040 per order Custom Finish Match  
 \$40 per chair Custom Chair Heights

*Only on select products, contact your rep for additional information.*

*See details in Ordering Information*

## GLIDES Available for LAURELWOOD, PLYFOLD, PLYLOK, VANTAGE, UNITY®, OAKLOK and WEDGEWOOD

\$11	7144000 Plastitack Glides	Set of four replacement glides	
\$11	7144012 Chrome Rubber Cushioned Glides	Set of four replacement glides	
\$11	7144013 Non-skid Rubber Cushioned Plastitack Glides	Set of four replacement glides	
\$11	7144022 Accessories Plastic Caps for 4012 Glides	Set of four replacement glides	

## INTERLOCKS Available for OAKLOK side chair, PLYLOK, UNITY® and VANTAGE

\$8	7074129 Straight Metal Interlock	Female mounted on right leg. Male mounted on left leg.	
-----	----------------------------------	--	---

## Available for OAKLOK side chair, PLYLOK, UNITY® and VANTAGE

\$47	7074130 Radius Metal Interlock	Female mounted on right leg. Male mounted on left leg.	
------	--------------------------------	--	---

# Quick Ship Program

---

## INFORMATION AND PRODUCT AVAILABILITY

Choose from the following models, standard finishes and selected fabrics:

### AVAILABLE MODELS

---

- Laurelwood (does not include urethane options)
- Link
- Oaklok
- Perk
- PlyFold
- PlyLok
- Trace Wood (does not include urethane or thermoform options)
- Vantage
- Wedgewood (does not include urethane options)

## QUICK SHIP TERMS AND CONDITIONS

---

1. A written, faxed or e-mailed purchase order must be received by Company before the order will be released for production.
2. Cancellations and change orders cannot be permitted after receipt of written, faxed or e-mailed purchase order.
3. Contact your rep for current quick ship lead times.  
  
Lead times on the Program may be extended at peak production times during the year, due to production schedules being at maximum capacity.
4. If Company program upholstery is back-ordered or COM upholstery is specified, your order will be produced 20 WORKING DAYS after receipt of upholstery requirements.
5. Maximum quantity for the Program is 25 chairs. Larger quantities require the standard lead-time.

# Materials & Finishes

## GENERAL INFORMATION

The Company furniture incorporates a variety of materials and finishes in our product offering. Not all materials and finishes are available on all products. The following pages provide information on the availability of standard materials and finishes, as well as custom options that are available. Fabric information is not included in this section.

Due to natural variations beyond Company's control, all materials including but not limited to fabric, wood or steel are sold subject to variations or irregularities of color, grain and texture. Because of these variations, Company's samples may not exactly match that of the finished product.

## NONSTANDARD MATERIALS

All nonstandard materials are subject to a surcharge. Contact the home office for approval and pricing. The use of nonstandard materials may cause extended delivery times and reduced warranty coverage.

## CUSTOM WOOD FINISHES

Contact the home office for finish match availability by product. Customer provides a sample for the color match and must approve the custom finish match before the order can be scheduled for production.

It is recommended that furniture being ordered for placement near existing products have a custom finish match. Color variances may occur between orders without a custom finish match. Custom finish matches for any standard company finish are available at no additional charge.

## WOOD FINISHES

Prices listed are based on the standard company wood finishes listed below. Wood finish names describe the color only, not the wood species. Stains are applied to the specific product's standard wood type such as maple, beech, oak. The standard species of each product is listed next to the product throughout the pricing pages. Not all finish colors are available on all products. Some finishes will require a minimum quantity when ordered on certain casegood products.

Natural 73	Amber 74	Honey 75
Nutmeg 76	Henna 77	Urban Cherry 78
Mahogany 79	Sepia 80	Walnut 81
Molasses 82	Black 83	Driftwood 409

## POLY AND PLASTIC FINISHES

Poly and plastic components are available for Upland seating. See the materials & finish options chart for availability.

Black	Light Grey
Sterling Grey	White

## HIGH DENSITY POLYETHYLENE (HDPE)

High density polyethylene material is used on the Accord Recliner Fold-down tables and Soul Mate Resin Overlay option. See the materials & finish options chart for availability.

White	Charcoal
Dolphin Grey	Nutmeg

## METAL POWDER COAT COLORS

Silver and black (available on all metal products)

## SPECIALTY POWDER COAT COLORS

**Accord™:** Silver, Black, Sable, and Dove

**sleepToo®:** Silver, Black, Bronze and Gunmetal

**Hale:** Silver, Black, Nickel, Soft White, Deep Taupe, Umber and Gray

**Canton, Upland, Pose, Delta, Amigo, Dune, Sprout, Fuse, Tubular,**

**Trumpet and Disc:** Silver, Black, Nickel, Soft White, Deep Taupe, Umber and Gray

## THERMOFORM FINISHES

Thermoform surfaces are available for some products. Cost may vary based on color, please call for information. Standard Thermoform colors available are:

Beige	Palos Mahogany	Hardrock Maple
Finesse	Shaker Cherry	Dark Grey
Honey Alder	Pepperdust	Verismo
Brushed Aluminum	Chocolate	Iona Gray
Monterey	Solara Oak	Calcutta Black

## WOOD FINISH THERMOFORM COORDINATES

WOOD FINISH	THERMOFORM MAPLE WOOD	THERMOFORM OAK WOOD
Natural 73	Hardrock Maple	NO MATCH
Amber 74	Honey Alder	Honey Alder
Honey 75	Solara Oak	Solara Oak
Nutmeg 76	Shaker Cherry	Shaker Cherry
Henna 77	NO MATCH	NO MATCH
Urban Cherry 78	Shaker Cherry	Shaker Cherry
Mahogany 79	NO MATCH	NO MATCH
Sepia 80	Palos Mahogany	Palos Mahogany
Driftwood 409	Iona Gray	Iona Gray
Walnut 81	Finesse	Finesse
Molasses 82	Verismo	Verismo
Black 83	Calcutta Black	Calcutta Black

Thermoform will never match a natural wood finish. Selections above are close coordinates to Company wood finishes.

## LAMINATE OPTIONS

Laminate options vary by product line. Individual table tops are available with standard laminates from Formica™, Nevamar™, Pionite™, and WilsonArt™. See the Laminates Thermoform Coordinates chart for additional laminate information. In-stock Wilsonart colors listed below are available on some products and specifying them will improve lead times and coordinate with matching 2MM PVC Wood Grain edges.

Designer White	Black	Dove Grey	Carbon Mesh
Shadow	Antique White	Fusion Maple	New Age Oak
Wild Cherry	Walnut Heights	Empire Mahogany	River Cherry
Cafelle	Studio Teak	Asian Night	

Specifying the above laminates on the following products will improve lead times:

Amigo	Canton	Dune
Monroe	Sprout	Fuse
Upland	Drum/Cube	Trumpet
Disc	Tubular	

# Materials & Finish Options

## NONSTANDARD AND CUSTOM LAMINATES

Nonstandard and custom/logo laminates are also available on select products for an additional upcharge. Please contact the Home Office for information on ordering nonstandard and custom/logo laminates.

## COORDINATING LAMINATES

COMPANY FINISH	BEECH WOOD SPECIES	MAPLE WOOD SPECIES	OAK WOOD SPECIES
Natural (73)	F: Amber Maple 7012-58	W: Fusion Maple 7909-60	W: Castle Oak 7928-38
Amber (74)	P: Millwork Cherry WC431-SD	F: Ginger Root Maple 7288-58	P: Taj Teak WT741-SD
Honey (75)	W: Brazilwood 7946-38	W: Brazilwood 7946-38	P: Wisconsin Oak WO581-SD
Nutmeg (76)	P: Spice Walnut WW561-SD	P: Spice Walnut WW561-SD	P: Spice Walnut WW561-SD
Henna (77)	P: Gunstock Savoy Walnut WW971-SD	P: Gunstock Savoy Walnut WW971-SD	P: Gunstock Savoy Walnut WW971-SD
Urban Cherry (78)	P: Sipping Seattle Java PFA48-SD	P: Sipping Seattle Java PFA48-SD	F: Select Cherry 7759-58
Mahogany (79)	W: Empire Mahogany 7122K-78	W: Empire Mahogany 7122K-78	W: Empire Mahogany 7122K-78
Sepia (80)	W: Studio Teak 7960K-18	W: Studio Teak 7960K-18	W: Studio Teak 7960K-18
Driftwood (409)	P: Pralines & Cream WW160-SD	P: Pralines & Cream WW160-SD	P: Pralines & Cream WW160-SD
Walnut (81)	W: Warehouse Oak 7969K-12	W: Warehouse Oak 7969K-12	W: Warehouse Oak 7969K-12
Molasses (82)	W: Cafelle 7933K-07	W: Cafelle 7933K-07	W: Cafelle 7933K-07
Black (83)	W: Black 1595-60	W: Black 1595-60	W: Black 1595-60

The chart above lists laminates which coordinate with our standard wood finishes. These are recommendations only – it is strongly recommended that samples are requested to ensure the match is satisfactory to individual customer preferences.

F: Formica      N: Nevamar      P: Pionite      W: WilsonArt

## URETHANE AND NYLON COLORS - ARM CAPS

Black      Sable      Dove

## SOLID SURFACE OPTIONS

All standard, stocked colors are listed below. Call for more information.

Glacier White      Linen      Cameo White  
Antarctica      Bisque      Dove

## FLAT PVC AND 2MM BIO EDGE COLORS

**Canton, Upland, Amigo, Dune, Sprout, Fuse, Tubular, Trumpet and Disc:**  
Silver, Black, Nickel, Soft White, Deep Taupe, Umber and Gray

## 2MM PVC WOOD GRAIN EDGE COLORS

**Canton, Monroe, Upland, Amigo, Dune, Sprout, Fuse, Tubular, Trumpet and Disc:** Asian Night, Cafelle, Empire Mahogany, Fusion Maple, New Age Oak, River Cherry, Studio Teak, Walnut Heights and Wild Cherry

# Materials & Finish Options

	wood				non-wood			urethane			poly seat		nylon			metal powder coat			solid surface						plastic					
	oak	maple	beech	cherry	thermoform	laminata	engineered resin	black	sable	dove	black	sterling grey	black	sable	dove	black	silver	specialty	glacier white	carneo white	bisque	linen	antarctica	dove	black	light grey	white	dolphin	charcoal	nutmeg
Accord™		•			•	•		•	•	•						•	•	2	•	•	•	•	•	•				•	•	•
Allay®		•			•			•	•	•						•	1		•	•	•	•	•	•						
Amari					•			•	•	•									•	•	•	•	•	•						
Amigo						•										•	•	2	•	•	•	•	•	•						
Canton			•			•		•	•	•						•	•	2	•	•	•	•	•	•						
Capital		•						•	•	•																				
Chancel	•	•	•	•																										
Cove		•						•	•	•						•			•	•	•	•	•	•						
Delta																•	•	2												
Dune			•			•										•	•	2												
Hale					•											•	•	2	•	•	•	•	•	•						
Latitude			•													•			•	•	•	•	•	•						
Link			•										•	•	•															
Laurelwood			•					•	•	•																				
Monroe			•			•		•																						
Oaklok	•	•	•	•																										
Perk						•																								
Plyfold			•																											
Plylok			•																											
Pose																•	•	2												
Rally		•				•											•													
sleepToo®		•				•		•	•	•						•	•	2	•	•	•	•	•	•						
Soul						•											•		•	•	•	•	•	•			•	•	•	•
Sprout						•										•	•	2												
Trace						•	•	•	•	•							•		•	•	•	•	•	•						
Trey-G®												•																		
Unity®	•	•	•	•																										
Upland		•										•	•			•	•	2								•	•	•		
Vantage			•																											
Versant		•						•	•	•																				
Wedgewood			•					•	•	•																				
4700 Tables					•												•		•	•	•	•	•	•						
Fuse						•										•	•	2												
Trumpet & Disc						•										•	•	2												
Tubular						•										•	•	2												

1. Metal finish is natural aluminum and is a warmer tone than silver.
2. See Materials and Finishes section for additional specialty powder coat colors.

# Order Checklist

---

Please use this checklist to assure that you are providing company the necessary information to accurately process your order. Correct information assures better lead times. If you have any questions, please contact your company sales representative.

## GENERAL INFORMATION

---

- Bill To
- Ship To
- Project Name (Complete End User Information)
- Phone Number to Call for Questions
- Contact Name
- Unit Prices
- Discount Used
- Freight and Carrier Information
- Tagging Information
- Requested Delivery Date
- Contract Name and Number

## SEATING UNITS

---

- Model Number
- Fabric Vendor
- Fabric Patterns
- Fabric Colors
- Plastic or Nylon Color
- Arm Cap Option
- Wood Species
- Wood or Metal Finish
- Solid Surface Color
- Flammability Upcharge, if applicable (CA TB133/Boston Fire Code)
- Zoning Diagram, if applicable

## COM FABRIC

---

- 8" x 8" Fabric Memo Sample (Qty: 2)
- Fabric Vendor Name and Contact Information
- Fabric Pattern and Color
- Fabric Width
- Fabric Direction for Application
- Fabric Selvage Information (side or front)

## TABLES

---

- Wood Species
- Wood or Metal Finish
- Laminate Name, Color and Finish Type
- Base Finish
- Edge Profile (if applicable)
- Edge Color (if applicable)
- Solid Surface Color

## SUBMITTING FABRIC FOR PRODUCTION

---

- Job Name, City and State
- Purchase Order Number
- Send fabric directly to the address below, with the above information clearly marked on the roll:

Sauder® Manufacturing Co.  
C/O Wieland  
COM Fabric #XXXXXX (insert PO number)  
10785 Rose Avenue  
New Haven, IN 46774-9246

## MODULAR SEATING

---

- Drawings of furniture layout

## SPECIALS

---

- Is the Special clearly noted on the Purchase Order?
- Is the Special pricing reflected on the Purchase Order?

## CONTRACTS

---

- Contract Name and Number
- Special notes associated with the contract



## Seating & Coordinating Tables

# Accord™ Recliner

## CASTER/BRAKE OPTIONS

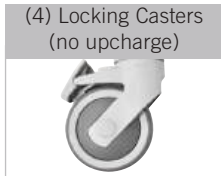

Specify black or grey.



Includes safeBrake central lock with (4) swivel casters. Specify black or grey.



Includes safeBrake central lock and intelliTrac™ caster system. Specify black or grey.

## ARM CAP OPTIONS



Standard. Specify black, sable or dove.



Specify wood finish.



Specify thermoform color.



Specify solid surface color.

## ARM OPTIONS



Standard. Specify fabric.



Specify thermoform color. One panel is \$488.

## ACCESSORIES



Specify right or left (as facing). Not available right side when flip table is specified.



Available right side only (as facing). Specify thermoform color.



Available right side only (as facing). Specify solid surface color.



Urethane only. Specify black, sable or dove.



Black only.



Available right side only (as facing). Not available when flip table is specified. Available with transfer arms.



Specify right or left (as facing). Not available on Transfer Arm side when specified.



21" seat height. Available with safeBrake option only. Not available when locking casters or intelliTrac casters are specified.



Available left side only (as facing). Specify black or silver.



Heat is located in the seat and the back. Massage is located in the back only.



Heat is located in the seat and the back.



Specify right, left or both (as facing). Not available when transfer arm is specified. Specify white, dolphin grey, charcoal or nutmeg.



Extra table bracket available. List Price is \$84.

# Accord™ Recliner

## OPTIONS

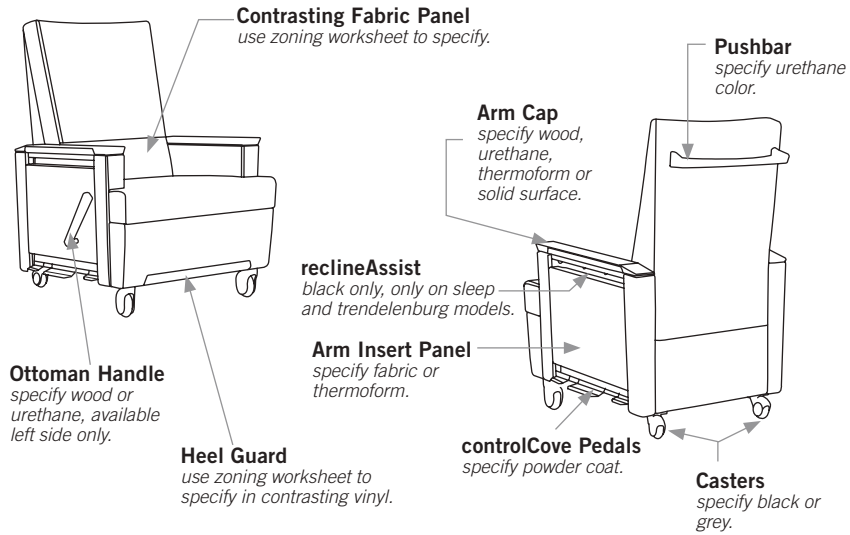

# Accord™ Recliner



## 65981 PATIENT RECLINER

W: 28.75" D: 36" H: 46.25" SW: 21.5" SD: 21" SH: 20" AH: 26.5" WT: 142 lb COM: 5.75 yd WT CAP: 500 lb

ZONE	B/COM	C	D	E	F	G	H	I	J	GENERAL INFORMATION
1	7265	7380	7489	7627	7857	8082	8312	8536	8766	MATERIAL: Maple
2	7444	7559	7668	7806	8036	8261	8491	8715	8945	MOIS. BARR: Included
3	7624	7739	7848	7986	8216	8441	8671	8895	9125	
4	7803	7918	8027	8165	8395	8620	8850	9074	9304	

## 65W981 PATIENT RECLINER, WIDE

W: 30.75" D: 36" H: 46.25" SW: 23.5" SD: 21" SH: 20" AH: 26.5" WT: 146 lb COM: 6 yd WT CAP: 500 lb

ZONE	B/COM	C	D	E	F	G	H	I	J	GENERAL INFORMATION
1	7850	7970	8084	8228	8468	8702	8942	9176	9416	MATERIAL: Maple
2	8044	8164	8278	8422	8662	8896	9136	9370	9610	MOIS. BARR: Included
3	8238	8358	8472	8616	8856	9090	9330	9564	9804	
4	8432	8552	8666	8810	9050	9284	9524	9758	9998	

## 65981S SLEEP RECLINER

W: 28.75" D: 36" H: 46.25" SW: 21.5" SD: 21" SH: 20" AH: 26.5" WT: 150 lb COM: 5.75 yd WT CAP: 500 lb

ZONE	B/COM	C	D	E	F	G	H	I	J	GENERAL INFORMATION
1	8050	8165	8274	8412	8642	8867	9097	9321	9551	MATERIAL: Maple
2	8249	8364	8473	8611	8841	9066	9296	9520	9750	MOIS. BARR: Included
3	8448	8563	8672	8810	9040	9265	9495	9719	9949	
4	8647	8762	8871	9009	9239	9464	9694	9918	10148	

## 65W981S SLEEP RECLINER, WIDE

W: 30.75" D: 36" H: 46.25" SW: 23.5" SD: 21" SH: 20" AH: 26.5" WT: 154 lb COM: 6 yd WT CAP: 500 lb

ZONE	B/COM	C	D	E	F	G	H	I	J	GENERAL INFORMATION
1	8641	8761	8875	9019	9259	9493	9733	9967	10207	MATERIAL: Maple
2	8855	8975	9089	9233	9473	9707	9947	10181	10421	MOIS. BARR: Included
3	9068	9188	9302	9446	9686	9920	10160	10394	10634	
4	9282	9402	9516	9660	9900	10134	10374	10608	10848	

## 65981T TRENDELENBURG RECLINER

W: 28.75" D: 36" H: 46.25" SW: 21.5" SD: 21" SH: 20" AH: 26.5" WT: 158 lb COM: 5.75 yd WT CAP: 500 lb

ZONE	B/COM	C	D	E	F	G	H	I	J	GENERAL INFORMATION
1	8446	8561	8670	8808	9038	9263	9493	9717	9947	MATERIAL: Maple
2	8655	8770	8879	9017	9247	9472	9702	9926	10156	MOIS. BARR: Included
3	8864	8979	9088	9226	9456	9681	9911	10135	10365	
4	9073	9188	9297	9435	9665	9890	10120	10344	10574	

## 65W981T TRENDELENBURG RECLINER, WIDE

W: 30.75" D: 36" H: 46.25" SW: 23.5" SD: 21" SH: 20" AH: 26.5" WT: 162 lb COM: 6 yd WT CAP: 500 lb

ZONE	B/COM	C	D	E	F	G	H	I	J	GENERAL INFORMATION
1	9035	9155	9269	9413	9653	9887	10127	10361	10601	MATERIAL: Maple
2	9258	9378	9492	9636	9876	10110	10350	10584	10824	MOIS. BARR: Included
3	9482	9602	9716	9860	10100	10334	10574	10808	11048	
4	9705	9825	9939	10083	10323	10557	10797	11031	11271	

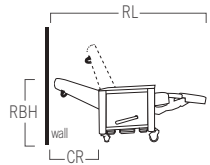

RL- Reclined length 74"

RBH- Reclined back height 28"

CR- Clearance required when placed against a wall is 24".

Dimensions above are based on standard Sleep Recliner model.

A 14" clearance is required from edge of chair when optional table is extended.

Width of chair does not include ottoman handle. An additional 2.25" is required to calculate overall width.

### Specify:

- Product Number
- Wood Finish
- Fabric Vendor, Pattern and Color
- Urethane Color
- Thermoform Color
- Solid Surface Color
- Powder Coat Color
- Caster Color
- Plastic Color

See pages 16 & 17 for material and finish options.

# Accord™ Sleep Chair

## ARM CAP OPTIONS

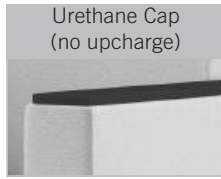

Standard. Specify black, sable or dove.



Specify solid surface color.



Specify thermoform color.



### 65841 SLEEP CHAIR

W: 30" D: 33.5" H: 33.25" SW: 24" SD: 21" SH: 18" AH: 25" WT: 110 lb COM: 5 yd WT CAP: 400 lb

ZONE	B/COM	C	D	E	F	G	H	I	J	GENERAL INFORMATION
1	7694	7794	7889	8009	8209	8404	8604	8799	8999	MATERIAL: Varies MOIS. BARR: Included
2	7884	7984	8079	8199	8399	8594	8794	8989	9189	
3	8075	8175	8270	8390	8590	8785	8985	9180	9380	
4	8265	8365	8460	8580	8780	8975	9175	9370	9570	

Casters are standard.

### 65W841 SLEEP CHAIR, WIDE

W: 36" D: 33.5" H: 33.25" SW: 30" SD: 21" SH: 18" AH: 25" WT: 128 lb COM: 6.5 yd WT CAP: 400 lb

ZONE	B/COM	C	D	E	F	G	H	I	J	GENERAL INFORMATION
1	8239	8369	8493	8649	8909	9162	9422	9676	9936	MATERIAL: Varies MOIS. BARR: Included
2	8442	8572	8696	8852	9112	9365	9625	9879	10139	
3	8646	8776	8900	9056	9316	9569	9829	10083	10343	
4	8849	8979	9103	9259	9519	9772	10032	10286	10546	

Casters are standard.

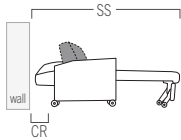

SS- Sleep surface 72"

CR- Clearance required to open sleep surface when placed against a wall is 10".

Specify:

- Product Number
- Fabric Vendor, Pattern and Color
- Urethane Color
- Solid Surface Color
- Thermoform Color

See pages 16 & 17 for material and finish options.

# Allay® Sleep Sofa

## ARM STYLES



600 Series



601 Series

Wood no upcharge  
Urethane no upcharge  
Solid surface \$384



Table Arm\*  
\$1309

Only available with solid surface top. Only available on 601 Series arm style. Specify solid surface color.

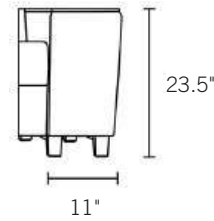

\*Add 11" to sleep surface width for table arm and 4" for non-table arm to get overall width.

## BASE OPTIONS

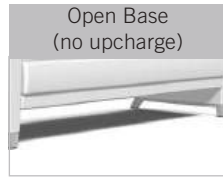

Open Base  
(no upcharge)



Continuous Base  
\$143

Fabric only.



Drawer  
\$442

Specify wood or thermoform. Not available on slim models.



Ottomans, Wood Panel  
\$1102 each

Specify right, left, or dual ottomans (as facing). Upholstery panels provided when only one ottoman specified. Not available on slim models or with table arm.

## TRUNDLE BED



Wood \$2544  
Therm \$2904

Specify wood or thermoform. Clearance with trundle bed open is 28". Weight capacity is 400 lbs. Includes mattress. Not available on slim models.

## LEG STYLES



Wood  
(no upcharge)



Metal Leg  
\$514



Casters  
\$555

Not available on trundle bed option.

## BACK SUPPORT PANEL



Wood (no upcharge)  
Thermoform \$442

Specify wood or thermoform.

## BACK STYLES

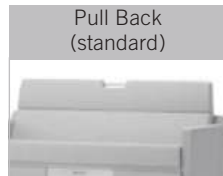

Pull Back  
(standard)



Straight Back  
(no upcharge)

## POWER OPTIONS



7700001 USB/120V  
Outlet \$829

OR



7700002 120V/120V  
Outlet \$701

Available in black or silver. Usable cord length is 9'. Please get facility approval on power options before ordering. Specify right, left, or both. Power units are UL Listed Tamper Resistant outlets. Available with table arm option only. Contact Customer Care for additional power options.

## METAL SURFACE FINISH OPTIONS

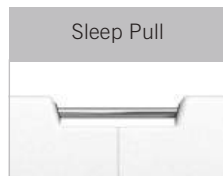

Sleep Pull

Specify natural aluminum or black.



Metal Leg

Specify natural aluminum or black.



Drawer Pull  
(if drawer is specified)

Specify natural aluminum or black.



Back Support Brackets

Specify natural aluminum or black.



Rear view.

## FINISH OPTIONS

**Arm Cap**  
Specify wood, urethane or solid surface (on 601 series). When urethane arm cap is specified, ottoman handle will be urethane also.

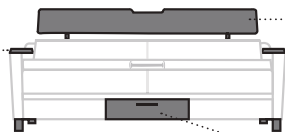

**Back Support Panel**  
specify wood or thermoform

**Drawer Front**  
specify wood or thermoform

**Ottoman Handle**  
specify wood or urethane

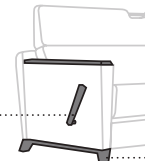

**Leg Assembly**  
specify wood or metal

# Allay® Sleep Sofa

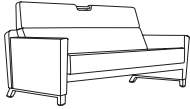

## 60066 SLEEP SOFA, SOFT TOP ARM, 66" SLEEP SURFACE, 74" WIDE

W: 74" D: 34" H: 38" SW: 66" SD: 21" SH: 18.5" AH: 23.5" WT: 171 lb COM: 12.25 yd WT CAP: 750 lb

ZONE	B/COM	C	D	E	F	G	H	I	J	GENERAL INFORMATION
1	8719	8964	9197	9491	9981	10459	10949	11426	11916	MATERIAL: Maple MOIS. BARR: Included
2	8932	9177	9410	9704	10194	10672	11162	11639	12129	
3	9145	9390	9623	9917	10407	10885	11375	11852	12342	
4	9358	9603	9836	10130	10620	11098	11588	12065	12555	

## 60069 SLEEP SOFA, SOFT TOP ARM, 69" SLEEP SURFACE, 77" WIDE

W: 77" D: 34" H: 38" SW: 69" SD: 21" SH: 18.5" AH: 23.5" WT: 177 lb COM: 12.25 yd WT CAP: 750 lb

ZONE	B/COM	C	D	E	F	G	H	I	J	GENERAL INFORMATION
1	8860	9105	9338	9632	10122	10600	11090	11567	12057	MATERIAL: Maple MOIS. BARR: Included
2	9077	9322	9555	9849	10339	10817	11307	11784	12274	
3	9293	9538	9771	10065	10555	11033	11523	12000	12490	
4	9510	9755	9988	10282	10772	11250	11740	12217	12707	

## 60072 SLEEP SOFA, SOFT TOP ARM, 72" SLEEP SURFACE, 80" WIDE

W: 80" D: 34" H: 38" SW: 72" SD: 21" SH: 18.5" AH: 23.5" WT: 183 lb COM: 12.25 yd WT CAP: 750 lb

ZONE	B/COM	C	D	E	F	G	H	I	J	GENERAL INFORMATION
1	8994	9239	9472	9766	10256	10734	11224	11701	12191	MATERIAL: Maple MOIS. BARR: Included
2	9214	9459	9692	9986	10476	10954	11444	11921	12411	
3	9434	9679	9912	10206	10696	11174	11664	12141	12631	
4	9654	9899	10132	10426	10916	11394	11884	12361	12851	

## 60075 SLEEP SOFA, SOFT TOP ARM, 75" SLEEP SURFACE, 83" WIDE

W: 83" D: 34" H: 38" SW: 75" SD: 21" SH: 18.5" AH: 23.5" WT: 189 lb COM: 12.25 yd WT CAP: 750 lb

ZONE	B/COM	C	D	E	F	G	H	I	J	GENERAL INFORMATION
1	9130	9375	9608	9902	10392	10870	11360	11837	12327	MATERIAL: Maple MOIS. BARR: Included
2	9353	9598	9831	10125	10615	11093	11583	12060	12550	
3	9577	9822	10055	10349	10839	11317	11807	12284	12774	
4	9800	10045	10278	10572	11062	11540	12030	12507	12997	

## 60078 SLEEP SOFA, SOFT TOP ARM, 78" SLEEP SURFACE, 86" WIDE

W: 86" D: 34" H: 38" SW: 78" SD: 21" SH: 18.5" AH: 23.5" WT: 195 lb COM: 12.25 yd WT CAP: 750 lb

ZONE	B/COM	C	D	E	F	G	H	I	J	GENERAL INFORMATION
1	9261	9506	9739	10033	10523	11001	11491	11968	12458	MATERIAL: Maple MOIS. BARR: Included
2	9488	9733	9966	10260	10750	11228	11718	12195	12685	
3	9714	9959	10192	10486	10976	11454	11944	12421	12911	
4	9941	10186	10419	10713	11203	11681	12171	12648	13138	

**Specify:**

- Product Number
- Wood Finish
- Urethane Color
- Fabric Vendor, Pattern and Color
- Thermoform Finish
- Solid Surface Color
- Metal Finish
- Base Option
- Leg Style Option
- Back Style Option
- Arm Style Option

See pages 16 & 17 for material and finish options.

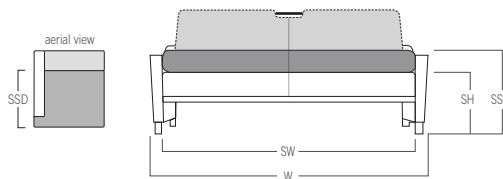

SSH- Sleep surface height 22.5"  
 SSD- Sleep surface depth 30.5"  
 SH- Seat height  
 SW- Seat width  
 W- Overall width  
 Add 4" to overall width for each ottoman specified.  
 Ottomans 14" from ground when extended.

# Allay® Sleep Sofa

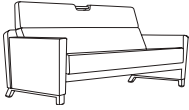

## 60166 SLEEP SOFA, UPH ARM W/CAP, 66" SLEEP SURFACE, 74" WIDE

W: 74" D: 34" H: 38" SW: 66" SD: 21" SH: 18.5" AH: 23.5" WT: 175 lb COM: 13 yd WT CAP: 750 lb

ZONE	B/COM	C	D	E	F	G	H	I	J	GENERAL INFORMATION
1	9339	9599	9846	10158	10678	11185	11705	12212	12732	MATERIAL: Maple MOIS. BARR: Included
2	9567	9827	10074	10386	10906	11413	11933	12440	12960	
3	9796	10056	10303	10615	11135	11642	12162	12669	13189	
4	10024	10284	10531	10843	11363	11870	12390	12897	13417	

## 60169 SLEEP SOFA, UPH ARM W/CAP, 69" SLEEP SURFACE, 77" WIDE

W: 77" D: 34" H: 38" SW: 69" SD: 21" SH: 18.5" AH: 23.5" WT: 181 lb COM: 13 yd WT CAP: 750 lb

ZONE	B/COM	C	D	E	F	G	H	I	J	GENERAL INFORMATION
1	9479	9739	9986	10298	10818	11325	11845	12352	12872	MATERIAL: Maple MOIS. BARR: Included
2	9711	9971	10218	10530	11050	11557	12077	12584	13104	
3	9943	10203	10450	10762	11282	11789	12309	12816	13336	
4	10174	10434	10681	10993	11513	12020	12540	13047	13567	

## 60172 SLEEP SOFA, UPH ARM W/CAP, 72" SLEEP SURFACE, 80" WIDE

W: 80" D: 34" H: 38" SW: 72" SD: 21" SH: 18.5" AH: 23.5" WT: 187 lb COM: 13 yd WT CAP: 750 lb

ZONE	B/COM	C	D	E	F	G	H	I	J	GENERAL INFORMATION
1	9606	9866	10113	10425	10945	11452	11972	12479	12999	MATERIAL: Maple MOIS. BARR: Included
2	9841	10101	10348	10660	11180	11687	12207	12714	13234	
3	10076	10336	10583	10895	11415	11922	12442	12949	13469	
4	10311	10571	10818	11130	11650	12157	12677	13184	13704	

## 60175 SLEEP SOFA, UPH ARM W/CAP, 75" SLEEP SURFACE, 83" WIDE

W: 83" D: 34" H: 38" SW: 75" SD: 21" SH: 18.5" AH: 23.5" WT: 193 lb COM: 13 yd WT CAP: 750 lb

ZONE	B/COM	C	D	E	F	G	H	I	J	GENERAL INFORMATION
1	9752	10012	10259	10571	11091	11598	12118	12625	13145	MATERIAL: Maple MOIS. BARR: Included
2	9991	10251	10498	10810	11330	11837	12357	12864	13384	
3	10229	10489	10736	11048	11568	12075	12595	13102	13622	
4	10468	10728	10975	11287	11807	12314	12834	13341	13861	

## 60178 SLEEP SOFA, UPH ARM W/CAP, 78" SLEEP SURFACE, 86" WIDE

W: 86" D: 34" H: 38" SW: 78" SD: 21" SH: 18.5" AH: 23.5" WT: 195 lb COM: 13 yd WT CAP: 750 lb

ZONE	B/COM	C	D	E	F	G	H	I	J	GENERAL INFORMATION
1	9885	10145	10392	10704	11224	11731	12251	12758	13278	MATERIAL: Maple MOIS. BARR: Included
2	10127	10387	10634	10946	11466	11973	12493	13000	13520	
3	10369	10629	10876	11188	11708	12215	12735	13242	13762	
4	10611	10871	11118	11430	11950	12457	12977	13484	14004	

**Specify:**

- Product Number
- Wood Finish
- Urethane Color
- Fabric Vendor, Pattern and Color
- Thermoform Finish
- Solid Surface Color
- Metal Finish
- Base Option
- Leg Style Option
- Back Style Option
- Arm Style Option

See pages 16 & 17 for material and finish options.

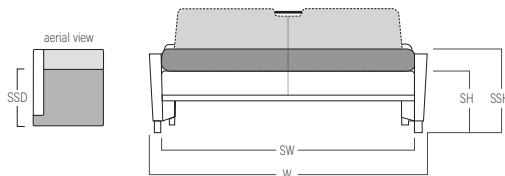

SSH- Sleep surface height 22.5"  
 SSD- Sleep surface depth 30.5"  
 SH- Seat height  
 SW- Seat width  
 W- Overall width  
 Add 4" to overall width for each ottoman specified.  
 Ottomans 14" from ground when extended.

# Allay® Sleep Sofa Slim

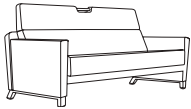

## 60066S SLEEP SOFA, SLIM, UPH ARM, 66" SLEEP SURFACE, 74" WIDE

W: 74" D: 30" H: 34" SW: 66" SD: 17" SH: 18.5" AH: 23.5" WT: 154 lb COM: 12 yd WT CAP: 750 lb

ZONE	B/COM	C	D	E	F	G	H	I	J	GENERAL INFORMATION
1	8715	8955	9183	9471	9951	10419	10899	11367	11847	MATERIAL: Maple
2	8928	9168	9396	9684	10164	10632	11112	11580	12060	MOIS. BARR: Included
3	9141	9381	9609	9897	10377	10845	11325	11793	12273	
4	9354	9594	9822	10110	10590	11058	11538	12006	12486	

## 60069S SLEEP SOFA, SLIM, UPH ARM, 69" SLEEP SURFACE, 77" WIDE

W: 77" D: 30" H: 34" SW: 69" SD: 17" SH: 18.5" AH: 23.5" WT: 160 lb COM: 12 yd WT CAP: 750 lb

ZONE	B/COM	C	D	E	F	G	H	I	J	GENERAL INFORMATION
1	8856	9096	9324	9612	10092	10560	11040	11508	11988	MATERIAL: Maple
2	9073	9313	9541	9829	10309	10777	11257	11725	12205	MOIS. BARR: Included
3	9289	9529	9757	10045	10525	10993	11473	11941	12421	
4	9506	9746	9974	10262	10742	11210	11690	12158	12638	

## 60072S SLEEP SOFA, SLIM, UPH ARM, 72" SLEEP SURFACE, 80" WIDE

W: 80" D: 30" H: 34" SW: 72" SD: 17" SH: 18.5" AH: 23.5" WT: 166 lb COM: 12 yd WT CAP: 750 lb

ZONE	B/COM	C	D	E	F	G	H	I	J	GENERAL INFORMATION
1	8990	9230	9458	9746	10226	10694	11174	11642	12122	MATERIAL: Maple
2	9210	9450	9678	9966	10446	10914	11394	11862	12342	MOIS. BARR: Included
3	9430	9670	9898	10186	10666	11134	11614	12082	12562	
4	9650	9890	10118	10406	10886	11354	11834	12302	12782	

## 60075S SLEEP SOFA, SLIM, UPH ARM, 75" SLEEP SURFACE, 83" WIDE

W: 83" D: 30" H: 34" SW: 75" SD: 17" SH: 18.5" AH: 23.5" WT: 172 lb COM: 12 yd WT CAP: 750 lb

ZONE	B/COM	C	D	E	F	G	H	I	J	GENERAL INFORMATION
1	9126	9366	9594	9882	10362	10830	11310	11778	12258	MATERIAL: Maple
2	9349	9589	9817	10105	10585	11053	11533	12001	12481	MOIS. BARR: Included
3	9573	9813	10041	10329	10809	11277	11757	12225	12705	
4	9796	10036	10264	10552	11032	11500	11980	12448	12928	

## 60078S SLEEP SOFA, SLIM, UPH ARM, 78" SLEEP SURFACE, 86" WIDE

W: 86" D: 30" H: 34" SW: 78" SD: 17" SH: 18.5" AH: 23.5" WT: 178 lb COM: 12 yd WT CAP: 750 lb

ZONE	B/COM	C	D	E	F	G	H	I	J	GENERAL INFORMATION
1	9257	9497	9725	10013	10493	10961	11441	11909	12389	MATERIAL: Maple
2	9484	9724	9952	10240	10720	11188	11668	12136	12616	MOIS. BARR: Included
3	9710	9950	10178	10466	10946	11414	11894	12362	12842	
4	9937	10177	10405	10693	11173	11641	12121	12589	13069	

**Specify:**

- Product Number
- Wood Finish
- Urethane Color
- Fabric Vendor, Pattern and Color
- Thermoform Finish
- Solid Surface Color
- Metal Finish
- Base Option
- Leg Style Option
- Back Style Option
- Arm Style Option

See pages 16 & 17 for material and finish options.

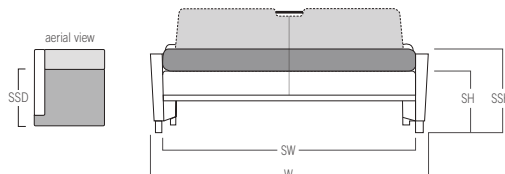

SSH- Sleep surface height 22.5"  
 SSD- Sleep surface depth 17"  
 SH- Seat height  
 SW- Seat width  
 W- Overall width

# Allay® Sleep Sofa Slim

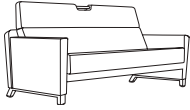

## 60166S SLEEP SOFA, SLIM, UPH ARM, ARM CAP, 66" SLEEP SURFACE, 74" WIDE

W: 74" D: 30" H: 34" SW: 66" SD: 17" SH: 18.5" AH: 23.5" WT: 158 lb COM: 12.5 yd WT CAP: 750 lb

ZONE	B/COM	C	D	E	F	G	H	I	J	GENERAL INFORMATION
1	9331	9581	9819	10119	10619	11106	11606	12094	12594	MATERIAL: Maple
2	9559	9809	10047	10347	10847	11334	11834	12322	12822	MOIS. BARR: Included
3	9788	10038	10276	10576	11076	11563	12063	12551	13051	
4	10016	10266	10504	10804	11304	11791	12291	12779	13279	

## 60169S SLEEP SOFA, SLIM UPH ARM, ARM CAP, 69" SLEEP SURFACE, 77" WIDE

W: 77" D: 30" H: 34" SW: 69" SD: 17" SH: 18.5" AH: 23.5" WT: 164 lb COM: 12.5 yd WT CAP: 750 lb

ZONE	B/COM	C	D	E	F	G	H	I	J	GENERAL INFORMATION
1	9471	9721	9959	10259	10759	11246	11746	12234	12734	MATERIAL: Maple
2	9703	9953	10191	10491	10991	11478	11978	12466	12966	MOIS. BARR: Included
3	9935	10185	10423	10723	11223	11710	12210	12698	13198	
4	10166	10416	10654	10954	11454	11941	12441	12929	13429	

## 60172S SLEEP SOFA, SLIM, UPH ARM, ARM CAP, 72" SLEEP SURFACE, 80" WIDE

W: 80" D: 30" H: 34" SW: 72" SD: 17" SH: 18.5" AH: 23.5" WT: 170 lb COM: 12.5 yd WT CAP: 750 lb

ZONE	B/COM	C	D	E	F	G	H	I	J	GENERAL INFORMATION
1	9598	9848	10086	10386	10886	11373	11873	12361	12861	MATERIAL: Maple
2	9833	10083	10321	10621	11121	11608	12108	12596	13096	MOIS. BARR: Included
3	10068	10318	10556	10856	11356	11843	12343	12831	13331	
4	10303	10553	10791	11091	11591	12078	12578	13066	13566	

## 60175S SLEEP SOFA, SLIM, UPH ARM, ARM CAP, 75" SLEEP SURFACE, 83" WIDE

W: 83" D: 30" H: 34" SW: 75" SD: 17" SH: 18.5" AH: 23.5" WT: 176 lb COM: 12.5 yd WT CAP: 750 lb

ZONE	B/COM	C	D	E	F	G	H	I	J	GENERAL INFORMATION
1	9744	9994	10232	10532	11032	11519	12019	12507	13007	MATERIAL: Maple
2	9983	10233	10471	10771	11271	11758	12258	12746	13246	MOIS. BARR: Included
3	10221	10471	10709	11009	11509	11996	12496	12984	13484	
4	10460	10710	10948	11248	11748	12235	12735	13223	13723	

## 60178S SLEEP SOFA, SLIM, UPH ARM, ARM CAP, 78" SLEEP SURFACE, 86" WIDE

W: 86" D: 30" H: 34" SW: 78" SD: 17" SH: 18.5" AH: 23.5" WT: 182 lb COM: 12.5 yd WT CAP: 750 lb

ZONE	B/COM	C	D	E	F	G	H	I	J	GENERAL INFORMATION
1	9877	10127	10365	10665	11165	11652	12152	12640	13140	MATERIAL: Maple
2	10119	10369	10607	10907	11407	11894	12394	12882	13382	MOIS. BARR: Included
3	10361	10611	10849	11149	11649	12136	12636	13124	13624	
4	10603	10853	11091	11391	11891	12378	12878	13366	13866	

**Specify:**

- Product Number
- Wood Finish
- Urethane Color
- Fabric Vendor, Pattern and Color
- Thermoform Finish
- Solid Surface Color
- Metal Finish
- Base Option
- Leg Style Option
- Back Style Option
- Arm Style Option

See pages 16 & 17 for material and finish options.

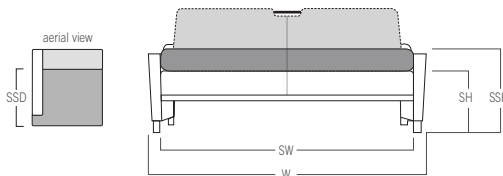

SSH- Sleep surface height 22.5"  
 SSD- Sleep surface depth 17"  
 SH- Seat height  
 SW- Seat width  
 W- Overall width

## CASTER/BRAKE OPTIONS



Specify black or grey.



Central brake with directional steering casters. Specify black or grey casters.

## ARM CAP OPTIONS



Specify solid surface color.



Standard. Specify black, sable or dove.

## ARM PANEL OPTIONS



Specify solid surface color.



Standard. Specify thermoform color.

## ACCESSORIES



Specify right, left or both (as facing). Not available right side when flip table is specified.



Available right side only (as facing). Specify color. Thermoform \$519 Solid Surface \$1039



Available right side only (as facing). Specify color. Thermoform \$519 Solid Surface \$1039



Black only.



Available right side only (as facing). Not available when Full Flip Table is specified. Available with transfer arms.



Urethane only. Specify black, sable or dove.



## 14981 AMARI RECLINER

W: 29" D: 34.25" H: 46.75" SW: 22" SD: 20.75" SH: 20" AH: 26.75" WT: 113 lb COM: 4 yd WT CAP: 500 lb

ZONE	B/COM	C	D	E	F	G	H	I	J	GENERAL INFORMATION
1	6254	6334	6410	6506	6666	6822	6982	7138	7298	MATERIAL: Varies MOIS. BARR: Included
2	6409	6489	6565	6661	6821	6977	7137	7293	7453	
3	6564	6644	6720	6816	6976	7132	7292	7448	7608	
4	6718	6798	6874	6970	7130	7286	7446	7602	7762	

## 14W981 AMARI RECLINER, WIDE

W: 32" D: 34.25" H: 46.75" SW: 25" SD: 20.75" SH: 20" AH: 26.75" WT: 125 lb COM: 4.25 yd WT CAP: 500 lb

ZONE	B/COM	C	D	E	F	G	H	I	J	GENERAL INFORMATION
1	6707	6792	6873	6975	7145	7311	7481	7646	7816	MATERIAL: Varies MOIS. BARR: Included
2	6873	6958	7039	7141	7311	7477	7647	7812	7982	
3	7039	7124	7205	7307	7477	7643	7813	7978	8148	
4	7205	7290	7371	7473	7643	7809	7979	8144	8314	

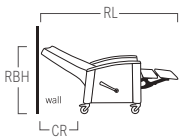

RL- Reclined length 70.5"

RBH- Reclined back height 34.5"

CR- Clearance required when placed against a wall is 20.5".

A 12.5 " clearance is required from edge of chair when optional table is extended.

**Specify:**

- Product Number
- Fabric Vendor, Pattern and Color
- Urethane Color
- Thermoform Color
- Solid Surface Color
- Caster Color

# Amigo Occasional Tables



## 8915DSK022 OCCASIONAL TABLE, 15" ROUND TOP, 22" HT

### GENERAL INFORMATION

W: 15" D: 15" H: 22" WT: 26 lb WT CAP: 200 lb

BASE MATERIAL: Metal  
TOP MATERIAL: Varies

Zone	1	2	3	4
	1040	1066	1092	1118

Laminate top with metal base is standard. Specify table top material, edge style and metal finish when ordering. Solid surface available for an additional charge.

## 8915DSK025 OCCASIONAL TABLE, 15" ROUND TOP, 25" HT

### GENERAL INFORMATION

W: 15" D: 15" H: 25" WT: 26 lb WT CAP: 200 lb

BASE MATERIAL: Metal  
TOP MATERIAL: Varies

Zone	1	2	3	4
	1040	1066	1092	1118

Laminate top with metal base is standard. Specify table top material, edge style and metal finish when ordering. Solid surface available for an additional charge.

## 8915DSK027 OCCASIONAL TABLE, 15" ROUND TOP, 27" HT

### GENERAL INFORMATION

W: 15" D: 15" H: 27" WT: 26 lb WT CAP: 200 lb

BASE MATERIAL: Metal  
TOP MATERIAL: Varies

Zone	1	2	3	4
	1040	1066	1092	1118

Laminate top with metal base is standard. Specify table top material, edge style and metal finish when ordering. Solid surface available for an additional charge.

## 8918DSK022 OCCASIONAL TABLE, 18" ROUND TOP, 22" HT

### GENERAL INFORMATION

W: 18" D: 18" H: 22" WT: 33 lb WT CAP: 200 lb

BASE MATERIAL: Metal  
TOP MATERIAL: Varies

Zone	1	2	3	4
	1150	1179	1208	1236

Laminate top with metal base is standard. Specify table top material, edge style and metal finish when ordering. Solid surface available for an additional charge.

## 8918DSK025 OCCASIONAL TABLE, 18" ROUND TOP, 25" HT

### GENERAL INFORMATION

W: 18" D: 18" H: 25" WT: 33 lb WT CAP: 200 lb

BASE MATERIAL: Metal  
TOP MATERIAL: Varies

Zone	1	2	3	4
	1150	1179	1208	1236

Laminate top with metal base is standard. Specify table top material, edge style and metal finish when ordering. Solid surface available for an additional charge.

## 8918DSK027 OCCASIONAL TABLE, 18" ROUND TOP, 27" HT

### GENERAL INFORMATION

W: 18" D: 18" H: 27" WT: 33 lb WT CAP: 200 lb

BASE MATERIAL: Metal  
TOP MATERIAL: Varies

Zone	1	2	3	4
	1150	1179	1208	1236

Laminate top with metal base is standard. Specify table top material, edge style and metal finish when ordering. Solid surface available for an additional charge.

### Table Top Options

#### SOLID SURFACE

\$765 per table

Specify solid surface color.

Specify:

- Product Number
- Metal Finish
- Edge Style and Finish
- Laminate Vendor, Pattern and Finish
- Solid Surface Name and Number

See pages 16 & 17 for material and finish options.

### Edge Style Options



#### FLAT PVC EDGE

Available in 7 colors to match metal finishes.



#### SELF EDGE

Matches top laminate.



#### 2MM BIO EDGE

Available in 7 colors to match metal finishes.



#### 2MM PVC WOOD GRAIN EDGE

Available in 9 wood grain colors to match standard laminates.

# Amigo Occasional Tables



## 8922DSK022 OCCASIONAL TABLE, 22" ROUND TOP, 22" HT

### GENERAL INFORMATION

W: 22" D: 22" H: 22" WT: 44 lb WT CAP: 200 lb

BASE MATERIAL: Metal  
TOP MATERIAL: Varies

Zone	1	2	3	4
	1331	1364	1398	1431

Laminate top with metal base is standard. Specify table top material, edge style and metal finish when ordering. Solid surface available for an additional charge.

## 8922DSK025 OCCASIONAL TABLE, 22" ROUND TOP, 25" HT

### GENERAL INFORMATION

W: 22" D: 22" H: 25" WT: 44 lb WT CAP: 200 lb

BASE MATERIAL: Metal  
TOP MATERIAL: Varies

Zone	1	2	3	4
	1331	1364	1398	1431

Laminate top with metal base is standard. Specify table top material, edge style and metal finish when ordering. Solid surface available for an additional charge.

## 8922DSK027 OCCASIONAL TABLE, 22" ROUND TOP, 27" HT

### GENERAL INFORMATION

W: 22" D: 22" H: 27" WT: 44 lb WT CAP: 200 lb

BASE MATERIAL: Metal  
TOP MATERIAL: Varies

Zone	1	2	3	4
	1331	1364	1398	1431

Laminate top with metal base is standard. Specify table top material, edge style and metal finish when ordering. Solid surface available for an additional charge.



## 8915SQSK022 OCCASIONAL TABLE, 15" SQUARE TOP, 22" HT

### GENERAL INFORMATION

W: 15" D: 15" H: 22" WT: 27 lb WT CAP: 200 lb

BASE MATERIAL: Metal  
TOP MATERIAL: Varies

Zone	1	2	3	4
	941	965	988	1012

Laminate top with metal base is standard. Specify table top material, edge style and metal finish when ordering. Solid surface available for an additional charge.

## 8915SQSK025 OCCASIONAL TABLE, 15" SQUARE TOP, 25" HT

### GENERAL INFORMATION

W: 15" D: 15" H: 25" WT: 27 lb WT CAP: 200 lb

BASE MATERIAL: Metal  
TOP MATERIAL: Varies

Zone	1	2	3	4
	941	965	988	1012

Laminate top with metal base is standard. Specify table top material, edge style and metal finish when ordering. Solid surface available for an additional charge.

## 8915SQSK027 OCCASIONAL TABLE, 15" SQUARE TOP, 27" HT

### GENERAL INFORMATION

W: 15" D: 15" H: 27" WT: 27 lb WT CAP: 200 lb

BASE MATERIAL: Metal  
TOP MATERIAL: Varies

Zone	1	2	3	4
	941	965	988	1012

Laminate top with metal base is standard. Specify table top material, edge style and metal finish when ordering. Solid surface available for an additional charge.

### Table Top Options

#### SOLID SURFACE

\$765 per table

Specify solid surface color.

#### Specify:

- Product Number
- Metal Finish
- Edge Style and Finish
- Laminate Vendor, Pattern and Finish
- Solid Surface Name and Number

See pages 16 & 17 for material and finish options.

### Edge Style Options



#### FLAT PVC EDGE

Available in 7 colors to match metal finishes.



#### SELF EDGE

Matches top laminate.



#### 2MM BIO EDGE

Available in 7 colors to match metal finishes.



#### 2MM PVC WOOD GRAIN EDGE

Available in 9 wood grain colors to match standard laminates.

# Amigo Occasional Tables



## 8918SQSK022 OCCASIONAL TABLE, 18" SQUARE TOP, 22" HT

GENERAL INFORMATION

W: 18" D: 18" H: 22" WT: 35 lb WT CAP: 200 lb

BASE MATERIAL: Metal  
TOP MATERIAL: Varies

Zone	1	2	3	4
	1090	1117	1144	1172

Laminate top with metal base is standard. Specify table top material, edge style and metal finish when ordering. Solid surface available for an additional charge.

## 8918SQSK025 OCCASIONAL TABLE, 18" SQUARE TOP, 25" HT

GENERAL INFORMATION

W: 18" D: 18" H: 25" WT: 35 lb WT CAP: 200 lb

BASE MATERIAL: Metal  
TOP MATERIAL: Varies

Zone	1	2	3	4
	1090	1117	1144	1172

Laminate top with metal base is standard. Specify table top material, edge style and metal finish when ordering. Solid surface available for an additional charge.

## 8918SQSK027 OCCASIONAL TABLE, 18" SQUARE TOP, 27" HT

GENERAL INFORMATION

W: 18" D: 18" H: 27" WT: 35 lb WT CAP: 200 lb

BASE MATERIAL: Metal  
TOP MATERIAL: Varies

Zone	1	2	3	4
	1090	1117	1144	1172

Laminate top with metal base is standard. Specify table top material, edge style and metal finish when ordering. Solid surface available for an additional charge.

## 8922SQSK022 OCCASIONAL TABLE, 22" SQUARE TOP, 22" HT

GENERAL INFORMATION

W: 22" D: 22" H: 22" WT: 47 lb WT CAP: 200 lb

BASE MATERIAL: Metal  
TOP MATERIAL: Varies

Zone	1	2	3	4
	1274	1306	1338	1370

Laminate top with metal base is standard. Specify table top material, edge style and metal finish when ordering. Solid surface available for an additional charge.

## 8922SQSK025 OCCASIONAL TABLE, 22" SQUARE TOP, 25" HT

GENERAL INFORMATION

W: 22" D: 22" H: 25" WT: 48 lb WT CAP: 200 lb

BASE MATERIAL: Metal  
TOP MATERIAL: Varies

Zone	1	2	3	4
	1274	1306	1338	1370

Laminate top with metal base is standard. Specify table top material, edge style and metal finish when ordering. Solid surface available for an additional charge.

## 8922SQSK027 OCCASIONAL TABLE, 22" SQUARE TOP, 27" HT

GENERAL INFORMATION

W: 22" D: 22" H: 27" WT: 48 lb WT CAP: 200 lb

BASE MATERIAL: Metal  
TOP MATERIAL: Varies

Zone	1	2	3	4
	1274	1306	1338	1370

Laminate top with metal base is standard. Specify table top material, edge style and metal finish when ordering. Solid surface available for an additional charge.

### Table Top Options

#### SOLID SURFACE

\$765 per table

Specify solid surface color.

Specify:

- Product Number
- Metal Finish
- Edge Style and Finish
- Laminate Vendor, Pattern and Finish
- Solid Surface Name and Number

See pages 16 & 17 for material and finish options.

### Edge Style Options



#### FLAT PVC EDGE

Available in 7 colors to match metal finishes.



#### SELF EDGE

Matches top laminate.



#### 2MM BIO EDGE

Available in 7 colors to match metal finishes.



#### 2MM PVC WOOD GRAIN EDGE

Available in 9 wood grain colors to match standard laminates.

## SIDE RAIL OPTIONS



*Specify wood finish.*



*Specify metal color.*

## ARM CAP OPTIONS



*Specify wood finish.*



*Specify black, sable or dove.*



\$624  
67CN12 (set of 3)

\$832  
67CN13M (set of 4)  
*Specify solid surface color.*

## FREESTANDING TABLE EDGE OPTIONS



*Available in 7 colors to match metal finishes.*

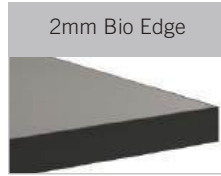

*Available in 7 colors to match metal finishes.*

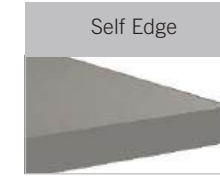

*Specify laminate color.*

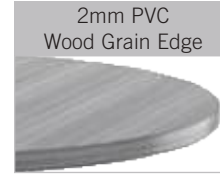

*Available in 9 wood grain colors to match standard laminates.*

## MODULAR TABLE EDGE OPTIONS



*Available in 7 colors to match metal finishes.*

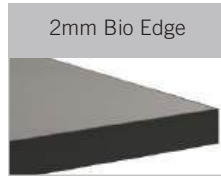

*Available in 7 colors to match metal finishes.*



*Specify laminate color.*



*Available in 9 wood grain colors to match standard laminates.*

## ACCESSORIES



# Canton



## 67CN01M CHAIR, METAL FRAME

W: 25" D: 26" H: 33.75" SW: 21" SD: 18" SH: 18" AH: 25" WT: 27 lb COM: 1.75 yd WT CAP: 500 lb

ZONE	B/COM	C	D	E	F	G	H	I	J	GENERAL INFORMATION
1	1786	1821	1854	1896	1966	2035	2105	2173	2243	MATERIAL: Maple MOIS. BARR: \$21
2	1830	1865	1898	1940	2010	2079	2149	2217	2287	
3	1874	1909	1942	1984	2054	2123	2193	2261	2331	
4	1918	1953	1986	2028	2098	2167	2237	2305	2375	

Wallsaver legs are standard.

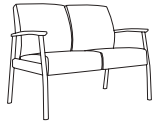

## 67CN02M LOVESEAT, METAL FRAME

W: 44.75" D: 26" H: 33.75" SW: 21" SD: 18" SH: 18" AH: 25" WT: 51 lb COM: 3.5 yd WT CAP: 750 lb

ZONE	B/COM	C	D	E	F	G	H	I	J	GENERAL INFORMATION
1	2939	3009	3076	3160	3300	3436	3576	3713	3853	MATERIAL: Maple MOIS. BARR: \$42
2	3011	3081	3148	3232	3372	3508	3648	3785	3925	
3	3083	3153	3220	3304	3444	3580	3720	3857	3997	
4	3155	3225	3292	3376	3516	3652	3792	3929	4069	

Wallsaver legs are standard.

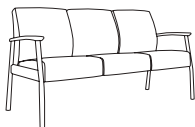

## 67CN03M SOFA, METAL FRAME

W: 67.5" D: 26" H: 33.75" SW: 21" SD: 18" SH: 18" AH: 25" WT: 75 COM: 5.25 yd WT CAP: 1000 lb

ZONE	B/COM	C	D	E	F	G	H	I	J	GENERAL INFORMATION
1	3990	4095	4195	4321	4531	4736	4946	5150	5360	MATERIAL: Maple MOIS. BARR: \$63
2	4088	4193	4293	4419	4629	4834	5044	5248	5458	
3	4185	4290	4390	4516	4726	4931	5141	5345	5555	
4	4283	4388	4488	4614	4824	5029	5239	5443	5653	

Wallsaver legs are standard.

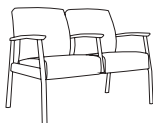

## 67CN12M LOVESEAT, METAL FRAME, SHORT CENTER ARMS

W: 48" D: 26" H: 33.75" SW: 21" SD: 18" SH: 18" AH: 25" WT: 51 lb COM: 3.5 yd WT CAP: 750 lb

ZONE	B/COM	C	D	E	F	G	H	I	J	GENERAL INFORMATION
1	3247	3317	3384	3468	3608	3744	3884	4021	4161	MATERIAL: Maple MOIS. BARR: \$42
2	3327	3397	3464	3548	3688	3824	3964	4101	4241	
3	3407	3477	3544	3628	3768	3904	4044	4181	4321	
4	3486	3556	3623	3707	3847	3983	4123	4260	4400	

Wallsaver legs are standard.

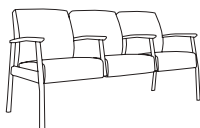

## 67CN13M SOFA, METAL FRAME, SHORT CENTER ARMS

W: 70.5" D: 26" H: 33.75" SW: 21" SD: 18" SH: 18" AH: 25" WT: 75 lb COM: 5.25 yd WT CAP: 1000 lb

ZONE	B/COM	C	D	E	F	G	H	I	J	GENERAL INFORMATION
1	4558	4663	4763	4889	5099	5304	5514	5718	5928	MATERIAL: Maple MOIS. BARR: \$63
2	4670	4775	4875	5001	5211	5416	5626	5830	6040	
3	4782	4887	4987	5113	5323	5528	5738	5942	6152	
4	4894	4999	5099	5225	5435	5640	5850	6054	6264	

Wallsaver legs are standard.

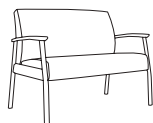

## 67CN01L LOVESEAT, METAL FRAME, CONTINUOUS SEAT

W: 46" D: 26" H: 33.75" SW: 42" SD: 18" SH: 18" AH: 25" WT: 51 lb COM: 3.5 yd WT CAP: 750 lb

ZONE	B/COM	C	D	E	F	G	H	I	J	GENERAL INFORMATION
1	2791	2861	2928	3012	3152	3288	3428	3565	3705	MATERIAL: Maple MOIS. BARR: \$42
2	2859	2929	2996	3080	3220	3356	3496	3633	3773	
3	2928	2998	3065	3149	3289	3425	3565	3702	3842	
4	2996	3066	3133	3217	3357	3493	3633	3770	3910	

Wallsaver legs are standard.

**Specify:**

- Product Number
- Wood Finish
- Metal Finish
- Urethane Cap Color
- Side Rail Option

See pages 16 & 17 for material and finish options.



## 67CN01G CHAIR, WIDE, METAL FRAME, BARIATRIC

W: 34" D: 26" H: 33.75" SW: 30" SD: 18" SH: 18" AH: 25" WT: 34 lb COM: 3 yd WT CAP: 750 lb

ZONE	B/COM	C	D	E	F	G	H	I	J	GENERAL INFORMATION
1	2271	2331	2388	2460	2580	2697	2817	2934	3054	MATERIAL: Maple MOIS. BARR: \$36
2	2327	2387	2444	2516	2636	2753	2873	2990	3110	
3	2382	2442	2499	2571	2691	2808	2928	3045	3165	
4	2438	2498	2555	2627	2747	2864	2984	3101	3221	

Wallsaver legs are standard.



## 67CN01H PATIENT CHAIR, METAL FRAME, HIGH BACK

W: 25" D: 26" H: 47.5" SW: 21" SD: 18" SH: 18" AH: 25" WT: 47 lb COM: 2.5 yd WT CAP: 500 lb

ZONE	B/COM	C	D	E	F	G	H	I	J	GENERAL INFORMATION
1	1996	2046	2094	2154	2254	2351	2451	2549	2649	MATERIAL: Maple MOIS. BARR: \$30
2	2045	2095	2143	2203	2303	2400	2500	2598	2698	
3	2094	2144	2192	2252	2352	2449	2549	2647	2747	
4	2143	2193	2241	2301	2401	2498	2598	2696	2796	

Wallsaver legs are not available.



## 67CN01ME EASY ACCESS CHAIR, METAL FRAME

W: 25" D: 26" H: 46" SW: 21" SD: 18" SH: 24" AH: 32" WT: 35 lb COM: 1.75 yd WT CAP: 500 lb

ZONE	B/COM	C	D	E	F	G	H	I	J	GENERAL INFORMATION
1	1955	1990	2023	2065	2135	2204	2274	2342	2412	MATERIAL: Maple MOIS. BARR: \$21
2	2003	2038	2071	2113	2183	2252	2322	2390	2460	
3	2051	2086	2119	2161	2231	2300	2370	2438	2508	
4	2100	2135	2168	2210	2280	2349	2419	2487	2557	

Wallsaver legs are standard.

**Specify:**

- Product Number
- Wood Finish
- Metal Finish
- Urethane Cap Color
- Side Rail Option

**See pages 16 & 17  
for material and finish  
options.**

# Canton Tables



## 67CN2424SQ FREESTANDING END TABLE, 24"

### GENERAL INFORMATION

W: 24"      D: 24"      H: 18"      WT: 47 lb

MATERIAL: Metal and Laminate  
MOIS BARR: -

Zone	1	2	3	4
	1030	1056	1082	1107

Price includes hard plastic clear glides. Laminate top with metal legs. Specify laminate, edge style & metal finish when ordering.

## 67CN3030SQ FREESTANDING END TABLE, 30"

### GENERAL INFORMATION

W: 30"      D: 30"      H: 18"      WT: 57 lb

MATERIAL: Metal and Laminate  
MOIS BARR: -

Zone	1	2	3	4
	1200	1230	1260	1290

Price includes hard plastic clear glides. Laminate top with metal legs. Specify laminate, edge style & metal finish when ordering.



## 67CN22DIA FREESTANDING END TABLE, ROUND

### GENERAL INFORMATION

W: 22"      D: 22"      H: 18"      WT: 47 lb

MATERIAL: Metal and Laminate  
MOIS BARR: -

Zone	1	2	3	4
	1288	1320	1352	1385

Price includes hard plastic clear glides. Laminate top with metal legs. Specify laminate, edge style & metal finish when ordering.



## 67CN2448RE FREESTANDING COFFEE TABLE, RECTANGULAR

### GENERAL INFORMATION

W: 48"      D: 24"      H: 18"      WT: 64 lb

MATERIAL: Metal and Laminate  
MOIS BARR: -

Zone	1	2	3	4
	1291	1323	1356	1388

Price includes hard plastic clear glides. Laminate top with metal legs. Specify laminate, edge style & metal finish when ordering.

#### Specify:

- Product Number
- Metal Finish
- Edge Style & Finish
- Laminate Vendor, Name and Number

See pages 16 & 17 for material and finish options.

# Canton Modular Tables



## 67CNTC45DEG CORNER TABLE, ANGLED, MODULAR

W: - D: - H: 18" WT: 19 lb

Zone	1	2	3	4
	1342	1376	1409	1443

### GENERAL INFORMATION

MATERIAL: Metal and Laminate  
MOIS BARR: -

Laminate top. Specify laminate and edge style when ordering. Modular seating orders must include a layout to ensure proper configuration.

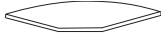

## 67CNRC2828 CORNER TABLE, RADIUS, MODULAR

W: 28" D: 18" H: 18" WT: 26 lb

Zone	1	2	3	4
	1342	1376	1409	1443

### GENERAL INFORMATION

MATERIAL: Metal and Laminate  
MOIS BARR: -

Laminate top. Specify laminate and edge style when ordering. Modular seating orders must include a layout to ensure proper configuration.



## 67CNSC2828 CORNER TABLE, SQUARE, MODULAR

W: 28" D: 28" H: 18" WT: 26 lb

Zone	1	2	3	4
	1469	1506	1542	1579

### GENERAL INFORMATION

MATERIAL: Metal and Laminate  
MOIS BARR: -

Laminate top. Specify laminate and edge style when ordering. Modular seating orders must include a layout to ensure proper configuration.



## 67CNST2121 SPANNER TABLE, MODULAR

W: 21" D: 21" H: 18" WT: 19 lb

Zone	1	2	3	4
	911	934	957	979

### GENERAL INFORMATION

MATERIAL: Metal and Laminate  
MOIS BARR: -

Laminate top. Specify laminate and edge style when ordering. Modular seating orders must include a layout to ensure proper configuration.

## 67CNET2121 END TABLE, MODULAR

W: 21" D: 21" H: 18" WT: 19 lb

Zone	1	2	3	4
	1217	1247	1278	1308

### GENERAL INFORMATION

MATERIAL: Metal and Laminate  
MOIS BARR: -

Laminate top. Specify laminate and edge style when ordering. Modular seating orders must include a layout to ensure proper configuration.

#### Specify:

- Product Number
- Edge Style & Finish
- Laminate Vendor, Name and Number

See pages 16 & 17 for material and finish options.

# Capital Gliders



## 32151G20 GLIDER, 20" SEAT, UPH ARM

W: 27.5" D: 30" H: 42" SW: 20" SD: 19.5" SH: 18.5" AH: 24.75" WT: 56 lb COM: 3.75 yd WT CAP: 350 lb

ZONE	B/COM	C	D	E	F	G	H	I	J	GENERAL INFORMATION
1	4351	4426	4497	4587	4737	4884	5034	5180	5330	MATERIAL: - MOIS. BARR: Included
2	4458	4533	4604	4694	4844	4991	5141	5287	5437	
3	4566	4641	4712	4802	4952	5099	5249	5395	5545	
4	4673	4748	4819	4909	5059	5206	5356	5502	5652	

The glider range from forward point to rear point is 41". A 7" clearance is required when placed against a wall.

## 32151G22 GLIDER, 22" SEAT, UPH ARM

W: 29.5" D: 30" H: 42" SW: 22" SD: 19.5" SH: 18.5" AH: 24.75" WT: 59 lb COM: 3.75 yd WT CAP: 350 lb

ZONE	B/COM	C	D	E	F	G	H	I	J	GENERAL INFORMATION
1	4536	4611	4682	4772	4922	5069	5219	5365	5515	MATERIAL: - MOIS. BARR: Included
2	4648	4723	4794	4884	5034	5181	5331	5477	5627	
3	4760	4835	4906	4996	5146	5293	5443	5589	5739	
4	4872	4947	5018	5108	5258	5405	5555	5701	5851	

The glider range from forward point to rear point is 41". A 7" clearance is required when placed against a wall.

## 32151G24 GLIDER, 24" SEAT, UPH ARM

W: 31.5" D: 30" H: 42" SW: 24" SD: 19.5" SH: 18.5" AH: 24.75" WT: 62 lb COM: 4 yd WT CAP: 350 lb

ZONE	B/COM	C	D	E	F	G	H	I	J	GENERAL INFORMATION
1	4723	4803	4879	4975	5135	5291	5451	5607	5767	MATERIAL: - MOIS. BARR: Included
2	4839	4919	4995	5091	5251	5407	5567	5723	5883	
3	4956	5036	5112	5208	5368	5524	5684	5840	6000	
4	5072	5152	5228	5324	5484	5640	5800	5956	6116	

The glider range from forward point to rear point is 41". A 7" clearance is required when placed against a wall.



## 32351G20 GLIDER, 20" SEAT, UPH ARM, SOLID SURFACE CAP

W: 27.5" D: 30" H: 42" SW: 20" SD: 19.5" SH: 18.5" AH: 24.75" WT: 58 lb COM: 3.75 yd WT CAP: 350 lb

ZONE	B/COM	C	D	E	F	G	H	I	J	GENERAL INFORMATION
1	4956	5031	5102	5192	5342	5489	5639	5785	5935	MATERIAL: - MOIS. BARR: Included
2	5078	5153	5224	5314	5464	5611	5761	5907	6057	
3	5201	5276	5347	5437	5587	5734	5884	6030	6180	
4	5323	5398	5469	5559	5709	5856	6006	6152	6302	

The glider range from forward point to rear point is 41". A 7" clearance is required when placed against a wall.

## 32351G22 GLIDER, 22" SEAT, UPH ARM, SOLID SURFACE CAP

W: 29.5" D: 30" H: 42" SW: 22" SD: 19.5" SH: 18.5" AH: 24.75" WT: 61 lb COM: 3.75 yd WT CAP: 350 lb

ZONE	B/COM	C	D	E	F	G	H	I	J	GENERAL INFORMATION
1	5130	5205	5276	5366	5516	5663	5813	5959	6109	MATERIAL: - MOIS. BARR: Included
2	5257	5332	5403	5493	5643	5790	5940	6086	6236	
3	5384	5459	5530	5620	5770	5917	6067	6213	6363	
4	5510	5585	5656	5746	5896	6043	6193	6339	6489	

The glider range from forward point to rear point is 41". A 7" clearance is required when placed against a wall.

## 32351G24 GLIDER, 24" SEAT, UPH ARM, SOLID SURFACE CAP

W: 31.5" D: 30" H: 42" SW: 24" SD: 19.5" SH: 18.5" AH: 24.75" WT: 64 lb COM: 3.75 yd WT CAP: 350 lb

ZONE	B/COM	C	D	E	F	G	H	I	J	GENERAL INFORMATION
1	5285	5365	5441	5537	5697	5853	6013	6169	6329	MATERIAL: - MOIS. BARR: Included
2	5416	5496	5572	5668	5828	5984	6144	6300	6460	
3	5546	5626	5702	5798	5958	6114	6274	6430	6590	
4	5677	5757	5833	5929	6089	6245	6405	6561	6721	

The glider range from forward point to rear point is 41". A 7" clearance is required when placed against a wall.

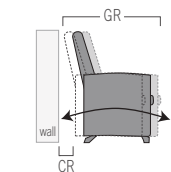

GR- Glider range from forward point to rear point is 41"

CR- Clearance required when placed against a wall is 7"

**Specify:**

- Product Number
- Solid Surface Cap Color
- Fabric Vendor, Pattern and Color

See pages 16 & 17 for material and finish options.

# Capital Gliders



## 32651G20 GLIDER, 20" SEAT, UPH ARM, URETHANE CAP

W: 27.5" D: 30" H: 42" SW: 20" SD: 19.5" SH: 18.5" AH: 24.75" WT: 58 lb COM: 3.75 yd WT CAP: 350 lb

ZONE	B/COM	C	D	E	F	G	H	I	J	GENERAL INFORMATION
1	4714	4789	4860	4950	5100	5247	5397	5543	5693	MATERIAL: -
2	4830	4905	4976	5066	5216	5363	5513	5659	5809	MOIS. BARR: Included
3	4947	5022	5093	5183	5333	5480	5630	5776	5926	
4	5063	5138	5209	5299	5449	5596	5746	5892	6042	

Urethane arm caps are available in black, sable or dove. The glider range from forward point to rear point is 41". A 7" clearance is required when placed against a wall.

## 32651G22 GLIDER, 22" SEAT, UPH ARM, URETHANE CAP

W: 29.5" D: 30" H: 42" SW: 22" SD: 19.5" SH: 18.5" AH: 24.75" WT: 61 lb COM: 3.75 yd WT CAP: 350 lb

ZONE	B/COM	C	D	E	F	G	H	I	J	GENERAL INFORMATION
1	4896	4971	5042	5132	5282	5429	5579	5725	5875	MATERIAL: -
2	5017	5092	5163	5253	5403	5550	5700	5846	5996	MOIS. BARR: Included
3	5138	5213	5284	5374	5524	5671	5821	5967	6117	
4	5259	5334	5405	5495	5645	5792	5942	6088	6238	

Urethane arm caps are available in black, sable or dove. The glider range from forward point to rear point is 41". A 7" clearance is required when placed against a wall.

## 32651G24 GLIDER, 24" SEAT, UPH ARM, URETHANE CAP

W: 31.5" D: 30" H: 42" SW: 24" SD: 19.5" SH: 18.5" AH: 24.75" WT: 64 lb COM: 3.75 yd WT CAP: 350 lb

ZONE	B/COM	C	D	E	F	G	H	I	J	GENERAL INFORMATION
1	5054	5129	5200	5290	5440	5587	5737	5883	6033	MATERIAL: -
2	5179	5254	5325	5415	5565	5712	5862	6008	6158	MOIS. BARR: Included
3	5304	5379	5450	5540	5690	5837	5987	6133	6283	
4	5429	5504	5575	5665	5815	5962	6112	6258	6408	

Urethane arm caps are available in black, sable or dove. The glider range from forward point to rear point is 41". A 7" clearance is required when placed against a wall.



## 32151LG20 GLIDER, 20" SEAT, UPH ARM, LOCKING MECHANISM

W: 27.5" D: 30" H: 42" SW: 20" SD: 19.5" SH: 18.5" AH: 24.75" WT: 58 lb COM: 3.75 yd WT CAP: 350 lb

ZONE	B/COM	C	D	E	F	G	H	I	J	GENERAL INFORMATION
1	4651	4726	4797	4887	5037	5184	5334	5480	5630	MATERIAL: -
2	4766	4841	4912	5002	5152	5299	5449	5595	5745	MOIS. BARR: Included
3	4881	4956	5027	5117	5267	5414	5564	5710	5860	
4	4995	5070	5141	5231	5381	5528	5678	5824	5974	

The glider range from forward point to rear point is 41". A 7" clearance is required when placed against a wall.

## 32151LG22 GLIDER, 22" SEAT, UPH ARM, LOCKING MECHANISM

W: 29.5" D: 30" H: 42" SW: 22" SD: 19.5" SH: 18.5" AH: 24.75" WT: 61 lb COM: 3.75 yd WT CAP: 350 lb

ZONE	B/COM	C	D	E	F	G	H	I	J	GENERAL INFORMATION
1	4848	4923	4994	5084	5234	5381	5531	5677	5827	MATERIAL: -
2	4968	5043	5114	5204	5354	5501	5651	5797	5947	MOIS. BARR: Included
3	5087	5162	5233	5323	5473	5620	5770	5916	6066	
4	5207	5282	5353	5443	5593	5740	5890	6036	6186	

The glider range from forward point to rear point is 41". A 7" clearance is required when placed against a wall.

## 32151LG24 GLIDER, 24" SEAT, UPH ARM, LOCKING MECHANISM

W: 31.5" D: 30" H: 42" SW: 24" SD: 19.5" SH: 18.5" AH: 24.75" WT: 64 lb COM: 4 yd WT CAP: 350 lb

ZONE	B/COM	C	D	E	F	G	H	I	J	GENERAL INFORMATION
1	5028	5108	5184	5280	5440	5596	5756	5912	6072	MATERIAL: -
2	5152	5232	5308	5404	5564	5720	5880	6036	6196	MOIS. BARR: Included
3	5276	5356	5432	5528	5688	5844	6004	6160	6320	
4	5400	5480	5556	5652	5812	5968	6128	6284	6444	

The glider range from forward point to rear point is 41". A 7" clearance is required when placed against a wall.

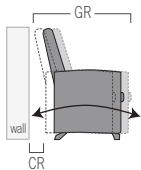

GR - Glider range from forward point to rear point is 41"

CR - Clearance required when placed against a wall is 7"

- Specify:
- Product Number
  - Urethane Cap Color
  - Fabric Vendor, Pattern and Color

See pages 16 & 17 for material and finish options.

# Capital Gliders



## 23251LG20 GLIDER, 20" SEAT, UPH ARM, SOLID SURFACE CAP, LOCKING MECHANISM

W: 27.5" D: 30" H: 42" SW: 20" SD: 19.5" SH: 18.5" AH: 24.75" WT: 58 lb COM: 3.75 yd WT CAP: 350 lb

ZONE	B/COM	C	D	E	F	G	H	I	J	GENERAL INFORMATION
1	5255	5330	5401	5491	5641	5788	5938	6084	6234	MATERIAL: -
2	5385	5460	5531	5621	5771	5918	6068	6214	6364	MOIS. BARR: Included
3	5515	5590	5661	5751	5901	6048	6198	6344	6494	
4	5645	5720	5791	5881	6031	6178	6328	6474	6624	

The glider range from forward point to rear point is 41". A 7" clearance is required when placed against a wall.

## 23251LG22 GLIDER, 22" SEAT, UPH ARM, SOLID SURFACE CAP, LOCKING MECHANISM

W: 29.5" D: 30" H: 42" SW: 22" SD: 19.5" SH: 18.5" AH: 24.75" WT: 61 lb COM: 3.75 yd WT CAP: 350 lb

ZONE	B/COM	C	D	E	F	G	H	I	J	GENERAL INFORMATION
1	5415	5490	5561	5651	5801	5948	6098	6244	6394	MATERIAL: -
2	5549	5624	5695	5785	5935	6082	6232	6378	6528	MOIS. BARR: Included
3	5683	5758	5829	5919	6069	6216	6366	6512	6662	
4	5817	5892	5963	6053	6203	6350	6500	6646	6796	

The glider range from forward point to rear point is 41". A 7" clearance is required when placed against a wall.

## 23251LG24 GLIDER, 24" SEAT, UPH ARM, SOLID SURFACE CAP, LOCKING MECHANISM

W: 31.5" D: 30" H: 42" SW: 24" SD: 19.5" SH: 18.5" AH: 24.75" WT: 64 lb COM: 4 yd WT CAP: 350 lb

ZONE	B/COM	C	D	E	F	G	H	I	J	GENERAL INFORMATION
1	5568	5648	5724	5820	5980	6136	6296	6452	6612	MATERIAL: -
2	5706	5786	5862	5958	6118	6274	6434	6590	6750	MOIS. BARR: Included
3	5843	5923	5999	6095	6255	6411	6571	6727	6887	
4	5981	6061	6137	6233	6393	6549	6709	6865	7025	

The glider range from forward point to rear point is 41". A 7" clearance is required when placed against a wall.



## 232651LG20 GLIDER, 20" SEAT, UPH ARM, URETHANE CAP, LOCKING MECHANISM

W: 27.5" D: 30" H: 42" SW: 20" SD: 19.5" SH: 18.5" AH: 24.75" WT: 58 lb COM: 3.75 yd WT CAP: 350 lb

ZONE	B/COM	C	D	E	F	G	H	I	J	GENERAL INFORMATION
1	5026	5101	5172	5262	5412	5559	5709	5855	6005	MATERIAL: -
2	5150	5225	5296	5386	5536	5683	5833	5979	6129	MOIS. BARR: Included
3	5274	5349	5420	5510	5660	5807	5957	6103	6253	
4	5398	5473	5544	5634	5784	5931	6081	6227	6377	

Urethane arm caps are available in black, sable or dove. The glider range from forward point to rear point is 41". A 7" clearance is required when placed against a wall.

## 232651LG22 GLIDER, 22" SEAT, UPH ARM, URETHANE CAP, LOCKING MECHANISM

W: 29.5" D: 30" H: 42" SW: 22" SD: 19.5" SH: 18.5" AH: 24.75" WT: 61 lb COM: 3.75 yd WT CAP: 350 lb

ZONE	B/COM	C	D	E	F	G	H	I	J	GENERAL INFORMATION
1	5193	5268	5339	5429	5579	5726	5876	6022	6172	MATERIAL: -
2	5321	5396	5467	5557	5707	5854	6004	6150	6300	MOIS. BARR: Included
3	5450	5525	5596	5686	5836	5983	6133	6279	6429	
4	5578	5653	5724	5814	5964	6111	6261	6407	6557	

Urethane arm caps are available in black, sable or dove. The glider range from forward point to rear point is 41". A 7" clearance is required when placed against a wall.

## 232651LG24 GLIDER, 24" SEAT, UPH ARM, URETHANE CAP, LOCKING MECHANISM

W: 31.5" D: 30" H: 42" SW: 24" SD: 19.5" SH: 18.5" AH: 24.75" WT: 64 lb COM: 3.75 yd WT CAP: 350 lb

ZONE	B/COM	C	D	E	F	G	H	I	J	GENERAL INFORMATION
1	5348	5423	5494	5584	5734	5881	6031	6177	6327	MATERIAL: -
2	5480	5555	5626	5716	5866	6013	6163	6309	6459	MOIS. BARR: Included
3	5612	5687	5758	5848	5998	6145	6295	6441	6591	
4	5745	5820	5891	5981	6131	6278	6428	6574	6724	

Urethane arm caps are available in black, sable or dove. The glider range from forward point to rear point is 41". A 7" clearance is required when placed against a wall.

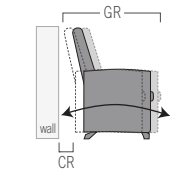

GR- Glider range from forward point to rear point is 41"

CR- Clearance required when placed against a wall is 7"

Specify:

- Product Number
- Solid Surface Cap Color
- Urethane Cap Color
- Fabric Vendor, Pattern and Color

See pages 16 & 17 for material and finish options.

# Capital Sleep Chairs



## 32841 SLEEP CHAIR

W: 30" D: 33.5" H: 33.25" SW: 24" SD: 21" SH: 18" AH: 25" WT: 110 lb COM: 5.25 yd WT CAP: 400 lb

ZONE	B/COM	C	D	E	F	G	H	I	J	GENERAL INFORMATION
1	6813	6918	7018	7144	7354	7559	7769	7973	8183	MATERIAL: Maple MOIS. BARR: Included
2	6981	7086	7186	7312	7522	7727	7937	8141	8351	
3	7149	7254	7354	7480	7690	7895	8105	8309	8519	
4	7318	7423	7523	7649	7859	8064	8274	8478	8688	



## 32W841 SLEEP CHAIR, WIDE

W: 36" D: 33.5" H: 33.25" SW: 30" SD: 21" SH: 18" AH: 25" WT: 128 lb COM: 6 yd WT CAP: 400 lb

ZONE	B/COM	C	D	E	F	G	H	I	J	GENERAL INFORMATION
1	7360	7480	7594	7738	7978	8212	8452	8686	8926	MATERIAL: Maple MOIS. BARR: Included
2	7542	7662	7776	7920	8160	8394	8634	8868	9108	
3	7723	7843	7957	8101	8341	8575	8815	9049	9289	
4	7905	8025	8139	8283	8523	8757	8997	9231	9471	



## 32841U SLEEP CHAIR, URETHANE CAP

W: 30" D: 33.5" H: 33.25" SW: 24" SD: 21" SH: 18" AH: 25" WT: 110 lb COM: 5.25 yd WT CAP: 400 lb

ZONE	B/COM	C	D	E	F	G	H	I	J	GENERAL INFORMATION
1	7180	7285	7385	7511	7721	7926	8136	8340	8550	MATERIAL: Maple MOIS. BARR: Included
2	7357	7462	7562	7688	7898	8103	8313	8517	8727	
3	7535	7640	7740	7866	8076	8281	8491	8695	8905	
4	7712	7817	7917	8043	8253	8458	8668	8872	9082	

Urethane arm caps are available in black, sable or dove.



## 32W841U SLEEP CHAIR, WIDE, URETHANE CAP

W: 36" D: 33.5" H: 33.25" SW: 30" SD: 21" SH: 18" AH: 25" WT: 128 lb COM: 6 yd WT CAP: 400 lb

ZONE	B/COM	C	D	E	F	G	H	I	J	GENERAL INFORMATION
1	7727	7847	7961	8105	8345	8579	8819	9053	9293	MATERIAL: Maple MOIS. BARR: Included
2	7918	8038	8152	8296	8536	8770	9010	9244	9484	
3	8109	8229	8343	8487	8727	8961	9201	9435	9675	
4	8299	8419	8533	8677	8917	9151	9391	9625	9865	

Urethane arm caps are available in black, sable or dove.

### Accessories

#### 32800-LC CASTERS

\$555 WT: 5 lb

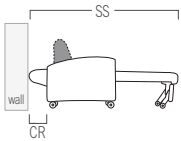

SS- Sleep surface 74"

CR- Clearance required to open sleep surface when placed against a wall is 10"

#### Specify:

- Product Number
- Wood Finish
- Urethane Cap Color
- Fabric Vendor, Pattern and Color

See pages 16 & 17 for material and finish options.



## 53411WB22 CHAIR, 22" SEAT, WOOD ARM, WOOD CAP

W: 27" D: 27.5" H: 32.5" SW: 22" SD: 20" SH: 18" AH: 25" WT: 41 lb COM: 2 yd WT CAP: 550 lb

ZONE	B/COM	C	D	E	F	G	H	I	J	GENERAL INFORMATION
1	3315	3355	3393	3441	3521	3599	3679	3757	3837	MATERIAL: Maple
2	3397	3437	3475	3523	3603	3681	3761	3839	3919	MOIS. BARR: Included
3	3479	3519	3557	3605	3685	3763	3843	3921	4001	
4	3561	3601	3639	3687	3767	3845	3925	4003	4083	

## 53411WB30 CHAIR, 30" SEAT, WOOD ARM, WOOD CAP

W: 35" D: 27.5" H: 32.5" SW: 30" SD: 20" SH: 18" AH: 25" WT: 54 lb COM: 2.75 yd WT CAP: 750 lb

ZONE	B/COM	C	D	E	F	G	H	I	J	GENERAL INFORMATION
1	4388	4443	4495	4561	4671	4779	4889	4996	5106	MATERIAL: Maple
2	4497	4552	4604	4670	4780	4888	4998	5105	5215	MOIS. BARR: Included
3	4605	4660	4712	4778	4888	4996	5106	5213	5323	
4	4714	4769	4821	4887	4997	5105	5215	5322	5432	

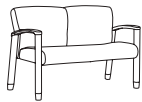

## 53411WB40 LOVESEAT, 40" SEAT, WOOD ARM, WOOD CAP

W: 45" D: 27.5" H: 32.5" SW: 40" SD: 20" SH: 18" AH: 25" WT: 64 lb COM: 2.75 yd WT CAP: 750 lb

ZONE	B/COM	C	D	E	F	G	H	I	J	GENERAL INFORMATION
1	5003	5058	5110	5176	5286	5394	5504	5611	5721	MATERIAL: Maple
2	5127	5182	5234	5300	5410	5518	5628	5735	5845	MOIS. BARR: Included
3	5251	5306	5358	5424	5534	5642	5752	5859	5969	
4	5375	5430	5482	5548	5658	5766	5876	5983	6093	



## 53410-2TW 2 SEAT TANDEM, WOOD ARM, WOOD CAP

W: 52.25" D: 27.5" H: 32.5" SW: 22" SD: 20" SH: 18" AH: 25" WT: 77 lb COM: 3.5 yd WT CAP: 550 lb

ZONE	B/COM	C	D	E	F	G	H	I	J	GENERAL INFORMATION
1	6011	6081	6148	6232	6372	6508	6648	6785	6925	MATERIAL: Maple
2	6160	6230	6297	6381	6521	6657	6797	6934	7074	MOIS. BARR: Included
3	6309	6379	6446	6530	6670	6806	6946	7083	7223	
4	6458	6528	6595	6679	6819	6955	7095	7232	7372	

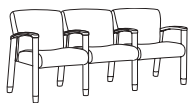

## 53410-3TW 3 SEAT TANDEM, WOOD ARM, WOOD CAP

W: 77" D: 27.5" H: 32.5" SW: 22" SD: 20" SH: 18" AH: 25" WT: 118 lb COM: 5 yd WT CAP: 550 lb

ZONE	B/COM	C	D	E	F	G	H	I	J	GENERAL INFORMATION
1	8521	8621	8716	8836	9036	9231	9431	9626	9826	MATERIAL: Maple
2	8732	8832	8927	9047	9247	9442	9642	9837	10037	MOIS. BARR: Included
3	8943	9043	9138	9258	9458	9653	9853	10048	10248	
4	9154	9254	9349	9469	9669	9864	10064	10259	10459	

**Specify:**

- Product Number
- Wood Finish
- Fabric Vendor, Pattern and Color

**See pages 16 & 17 for material and finish options.**



## 53411UB22 CHAIR, 22" SEAT, WOOD ARM, URETHANE CAP

W: 27" D: 27.5" H: 32.5" SW: 22" SD: 20" SH: 18" AH: 25" WT: 41 lb COM: 2 yd WT CAP: 550 lb

ZONE	B/COM	C	D	E	F	G	H	I	J	GENERAL INFORMATION
1	3315	3355	3393	3441	3521	3599	3679	3757	3837	MATERIAL: Maple
2	3397	3437	3475	3523	3603	3681	3761	3839	3919	MOIS. BARR: Included
3	3479	3519	3557	3605	3685	3763	3843	3921	4001	
4	3561	3601	3639	3687	3767	3845	3925	4003	4083	

Urethane arm caps are available in black, sable or dove.

## 53411UB30 CHAIR, 30" SEAT, WOOD ARM, URETHANE CAP

W: 35" D: 27.5" H: 32.5" SW: 30" SD: 20" SH: 18" AH: 25" WT: 54 lb COM: 2.75 yd WT CAP: 750 lb

ZONE	B/COM	C	D	E	F	G	H	I	J	GENERAL INFORMATION
1	4388	4443	4495	4561	4671	4779	4889	4996	5106	MATERIAL: Maple
2	4497	4552	4604	4670	4780	4888	4998	5105	5215	MOIS. BARR: Included
3	4605	4660	4712	4778	4888	4996	5106	5213	5323	
4	4714	4769	4821	4887	4997	5105	5215	5322	5432	

Urethane arm caps are available in black, sable or dove.

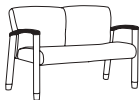

## 53411UB40 LOVESEAT, 40" SEAT, WOOD ARM, URETHANE CAP

W: 45" D: 27.5" H: 32.5" SW: 40" SD: 20" SH: 18" AH: 25" WT: 67 lb COM: 2.75 yd WT CAP: 750 lb

ZONE	B/COM	C	D	E	F	G	H	I	J	GENERAL INFORMATION
1	5003	5058	5110	5176	5286	5394	5504	5611	5721	MATERIAL: Maple
2	5127	5182	5234	5300	5410	5518	5628	5735	5845	MOIS. BARR: Included
3	5251	5306	5358	5424	5534	5642	5752	5859	5969	
4	5375	5430	5482	5548	5658	5766	5876	5983	6093	

Urethane arm caps are available in black, sable, dove or dove.



## 53410-2TU 2 SEAT TANDEM, WOOD ARM, URETHANE CAP

W: 52.25" D: 27.5" H: 32.5" SW: 22" SD: 20" SH: 18" AH: 25" WT: 81.5 lb COM: 3.5 yd WT CAP: 550 lb

ZONE	B/COM	C	D	E	F	G	H	I	J	GENERAL INFORMATION
1	6011	6081	6148	6232	6372	6508	6648	6785	6925	MATERIAL: Maple
2	6160	6230	6297	6381	6521	6657	6797	6934	7074	MOIS. BARR: Included
3	6309	6379	6446	6530	6670	6806	6946	7083	7223	
4	6458	6528	6595	6679	6819	6955	7095	7232	7372	

Urethane arm caps are available in black, sable, dove or dove.



## 53410-3TU 3 SEAT TANDEM, WOOD ARM, URETHANE CAP

W: 77" D: 27.5" H: 32.5" SW: 22" SD: 20" SH: 18" AH: 25" WT: 124 lb COM: 5 yd WT CAP: 550 lb

ZONE	B/COM	C	D	E	F	G	H	I	J	GENERAL INFORMATION
1	8521	8621	8716	8836	9036	9231	9431	9626	9826	MATERIAL: Maple
2	8732	8832	8927	9047	9247	9442	9642	9837	10037	MOIS. BARR: Included
3	8943	9043	9138	9258	9458	9653	9853	10048	10248	
4	9154	9254	9349	9469	9669	9864	10064	10259	10459	

Urethane arm caps are available in black, sable or dove.

Specify:

- Product Number
- Wood Finish
- Urethane Cap Color
- Fabric Vendor, Pattern and Color

**See pages 16 & 17 for material and finish options.**

# Cove Patient Chairs



## 53471WB22 PATIENT CHAIR, 22" SEAT, WOOD ARM, WOOD CAP

W: 27"	D: 30.5"	H: 41"	SW: 22"	SD: 20"	SH: 18"	AH: 25"	WT: 45 lb	COM: 2.25 yd	WT CAP: 550 lb	
ZONE	B/COM	C	D	E	F	G	H	I	J	GENERAL INFORMATION
1	3614	3659	3702	3756	3846	3934	4024	4111	4201	MATERIAL: Maple
2	3703	3748	3791	3845	3935	4023	4113	4200	4290	MOIS. BARR: Included
3	3793	3838	3881	3935	4025	4113	4203	4290	4380	
4	3882	3927	3970	4024	4114	4202	4292	4379	4469	



## 53471WB30 PATIENT CHAIR, 30" SEAT, WOOD ARM, WOOD CAP

W: 35"	D: 30.5"	H: 41"	SW: 30"	SD: 20"	SH: 18"	AH: 25"	WT: 59 lb	COM: 3.25 yd	WT CAP: 750 lb	
ZONE	B/COM	C	D	E	F	G	H	I	J	GENERAL INFORMATION
1	4715	4780	4842	4920	5050	5177	5307	5433	5563	MATERIAL: Maple
2	4832	4897	4959	5037	5167	5294	5424	5550	5680	MOIS. BARR: Included
3	4948	5013	5075	5153	5283	5410	5540	5666	5796	
4	5065	5130	5192	5270	5400	5527	5657	5783	5913	



## 53471UB22 PATIENT CHAIR, 22" SEAT, WOOD ARM, URETHANE CAP

W: 27"	D: 30.5"	H: 41"	SW: 22"	SD: 20"	SH: 18"	AH: 25"	WT: 45 lb	COM: 2.25 yd	WT CAP: 550 lb	
ZONE	B/COM	C	D	E	F	G	H	I	J	GENERAL INFORMATION
1	3614	3659	3702	3756	3846	3934	4024	4111	4201	MATERIAL: Maple
2	3703	3748	3791	3845	3935	4023	4113	4200	4290	MOIS. BARR: Included
3	3793	3838	3881	3935	4025	4113	4203	4290	4380	
4	3882	3927	3970	4024	4114	4202	4292	4379	4469	

Urethane arm caps are available in black, sable or dove.



## 53471UB30 PATIENT CHAIR, 30" SEAT, WOOD ARM, URETHANE CAP

W: 35"	D: 30.5"	H: 41"	SW: 30"	SD: 20"	SH: 18"	AH: 25"	WT: 59 lb	COM: 3.25 yd	WT CAP: 750 lb	
ZONE	B/COM	C	D	E	F	G	H	I	J	GENERAL INFORMATION
1	4715	4780	4842	4920	5050	5177	5307	5433	5563	MATERIAL: Maple
2	4832	4897	4959	5037	5167	5294	5424	5550	5680	MOIS. BARR: Included
3	4948	5013	5075	5153	5283	5410	5540	5666	5796	
4	5065	5130	5192	5270	5400	5527	5657	5783	5913	

Urethane arm caps are available in black, sable or dove.

**Specify:**

- Product Number
- Wood Finish
- Urethane Cap Color
- Fabric Vendor, Pattern and Color

**See pages 16 & 17 for material and finish options.**

# Cove Modular Seats



## 53411B22-M 1 SEAT, 22" SEAT, MODULAR

W: - D: 27.5" H: 32.5" SW: 22" SD: 20" SH: 18" AH: - WT: 29 lb COM: 2 yd WT CAP: 550 lb

ZONE	B/COM	C	D	E	F	G	H	I	J	GENERAL INFORMATION
1	1547	1587	1625	1673	1753	1831	1911	1989	2069	MATERIAL: -
2	1585	1625	1663	1711	1791	1869	1949	2027	2107	MOIS. BARR: Included
3	1623	1663	1701	1749	1829	1907	1987	2065	2145	
4	1661	1701	1739	1787	1867	1945	2025	2103	2183	

Shaded portion of the illustration indicates the product being described. Modular seating orders must include a layout to ensure proper configuration. Arms MUST be ordered separately from seat and back cushions - please note the product descriptions on this page.

## 53411B30-M 1 SEAT, 30" SEAT, MODULAR

W: - D: 27.5" H: 32.5" SW: 30" SD: 20" SH: 18" AH: - WT: 42 lb COM: 2.75 yd WT CAP: 750 lb

ZONE	B/COM	C	D	E	F	G	H	I	J	GENERAL INFORMATION
1	2673	2728	2780	2846	2956	3064	3174	3281	3391	MATERIAL: -
2	2739	2794	2846	2912	3022	3130	3240	3347	3457	MOIS. BARR: Included
3	2804	2859	2911	2977	3087	3195	3305	3412	3522	
4	2870	2925	2977	3043	3153	3261	3371	3478	3588	

Shaded portion of the illustration indicates the product being described. Modular seating orders must include a layout to ensure proper configuration. Arms MUST be ordered separately from seat and back cushions - please note the product descriptions on this page.

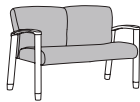

## 53411B40-M 1 LOVESEAT, 40" SEAT, MODULAR

W: - D: 27.5" H: 32.5" SW: 40" SD: 20" SH: 18" AH: - WT: 52 lb COM: 2.75 yd WT CAP: 750 lb

ZONE	B/COM	C	D	E	F	G	H	I	J	GENERAL INFORMATION
1	3317	3372	3424	3490	3600	3708	3818	3925	4035	MATERIAL: -
2	3399	3454	3506	3572	3682	3790	3900	4007	4117	MOIS. BARR: Included
3	3481	3536	3588	3654	3764	3872	3982	4089	4199	
4	3562	3617	3669	3735	3845	3953	4063	4170	4280	

Shaded portion of the illustration indicates the product being described. Modular seating orders must include a layout to ensure proper configuration. Arms MUST be ordered separately from seat and back cushions - please note the product descriptions on this page.

**Specify:**

- Product Number
- Fabric Vendor, Pattern and Color
- Room Layout

See pages 16 & 17 for material and finish options.

# Cove Modular Arms



## 53410WB-LA LEFT ARM, WOOD, WOOD CAP, MODULAR

### GENERAL INFORMATION

W: 2.75" D: 25.75" H: 25" WT: 6 lb

MATERIAL: Maple  
MOIS BARR: -

Zone	1	2	3	4
	961	985	1009	1033

Shaded portion of the illustration indicates the product being described. Modular seating orders must include a layout to ensure proper configuration. Seat and back cushions MUST be ordered separately from arms - please note the product descriptions on this page.



## 53410WB-RA RIGHT ARM, WOOD, WOOD CAP, MODULAR

### GENERAL INFORMATION

W: 2.75" D: 25.75" H: 25" WT: 6 lb

MATERIAL: Maple  
MOIS BARR: -

Zone	1	2	3	4
	961	985	1009	1033

Shaded portion of the illustration indicates the product being described. Modular seating orders must include a layout to ensure proper configuration. Seat and back cushions MUST be ordered separately from arms - please note the product descriptions on this page.

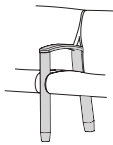

## 53410WB-CA CENTER ARM, WOOD, WOOD CAP, MODULAR

### GENERAL INFORMATION

W: 2.75" D: 25.75" H: 25" WT: 6 lb

MATERIAL: Maple  
MOIS BARR: -

Zone	1	2	3	4
	961	985	1009	1033

Shaded portion of the illustration indicates the product being described. Modular seating orders must include a layout to ensure proper configuration. Seat and back cushions MUST be ordered separately from arms - please note the product descriptions on this page.



## 53410UB-LA LEFT ARM, WOOD, URETHANE CAP, MODULAR

### GENERAL INFORMATION

W: 2.75" D: 25.75" H: 25" WT: 7.5 lb

MATERIAL: Maple  
MOIS BARR: -

Zone	1	2	3	4
	961	985	1009	1033

Shaded portion of the illustration indicates the product being described. Modular seating orders must include a layout to ensure proper configuration. Seat and back cushions MUST be ordered separately from arms - please note the product descriptions on this page. Urethane arm caps are available in black, sable or dove.



## 53410UB-RA RIGHT ARM, WOOD, URETHANE CAP, MODULAR

### GENERAL INFORMATION

W: 2.75" D: 25.75" H: 25" WT: 7.5 lb

MATERIAL: Maple  
MOIS BARR: -

Zone	1	2	3	4
	961	985	1009	1033

Shaded portion of the illustration indicates the product being described. Modular seating orders must include a layout to ensure proper configuration. Seat and back cushions MUST be ordered separately from arms - please note the product descriptions on this page. Urethane arm caps are available in black, sable or dove.

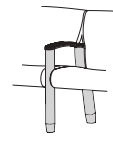

## 53410UB-CA CENTER ARM, WOOD, URETHANE CAP, MODULAR

### GENERAL INFORMATION

W: 2.75" D: 25.75" H: 25" WT: 7.5 lb

MATERIAL: Maple  
MOIS BARR: -

Zone	1	2	3	4
	961	985	1009	1033

Shaded portion of the illustration indicates the product being described. Modular seating orders must include a layout to ensure proper configuration. Seat and back cushions MUST be ordered separately from arms - please note the product descriptions on this page. Urethane arm caps are available in black, sable or dove.

#### Specify:

- Product Number
- Wood Finish
- Urethane Cap Color
- Room Layout

See pages 16 & 17 for material and finish options.

# Cove Lounge



## 53L411W CHAIR, WOOD ARM, WOOD CAP

W: 30" D: 32.5" H: 32.5" SW: 24" SD: 21" SH: 18.5" AH: 24" WT: 62 lb COM: 2.75 yd WT CAP: 550 lb

ZONE	B/COM	C	D	E	F	G	H	I	J	GENERAL INFORMATION
1	4274	4329	4381	4447	4557	4665	4775	4882	4992	MATERIAL: Maple
2	4380	4435	4487	4553	4663	4771	4881	4988	5098	MOIS. BARR: Included
3	4486	4541	4593	4659	4769	4877	4987	5094	5204	
4	4591	4646	4698	4764	4874	4982	5092	5199	5309	



## 53L412W LOVESEAT, WOOD ARM, WOOD CAP

W: 54" D: 32.5" H: 32.5" SW: 48" SD: 21" SH: 18.5" AH: 24" WT: 95 lb COM: 4.5 yd WT CAP: 650 lb

ZONE	B/COM	C	D	E	F	G	H	I	J	GENERAL INFORMATION
1	6267	6357	6443	6551	6731	6906	7086	7262	7442	MATERIAL: Maple
2	6422	6512	6598	6706	6886	7061	7241	7417	7597	MOIS. BARR: Included
3	6577	6667	6753	6861	7041	7216	7396	7572	7752	
4	6732	6822	6908	7016	7196	7371	7551	7727	7907	

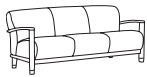

## 53L413W SOFA, WOOD ARM, WOOD CAP

W: 76" D: 32.5" H: 32.5" SW: 72" SD: 21" SH: 18.5" AH: 24" WT: 128 lb COM: 6.25 yd WT CAP: 750 lb

ZONE	B/COM	C	D	E	F	G	H	I	J	GENERAL INFORMATION
1	7732	7857	7976	8126	8376	8620	8870	9113	9363	MATERIAL: Maple
2	7923	8048	8167	8317	8567	8811	9061	9304	9554	MOIS. BARR: Included
3	8114	8239	8358	8508	8758	9002	9252	9495	9745	
4	8304	8429	8548	8698	8948	9192	9442	9685	9935	



## 53L411U CHAIR, WOOD ARM, URETHANE CAP

W: 30" D: 32.5" H: 32.5" SW: 24" SD: 21" SH: 18.5" AH: 24" WT: 62 lb COM: 2.75 yd WT CAP: 550 lb

ZONE	B/COM	C	D	E	F	G	H	I	J	GENERAL INFORMATION
1	4274	4329	4381	4447	4557	4665	4775	4882	4992	MATERIAL: Maple
2	4380	4435	4487	4553	4663	4771	4881	4988	5098	MOIS. BARR: Included
3	4486	4541	4593	4659	4769	4877	4987	5094	5204	
4	4591	4646	4698	4764	4874	4982	5092	5199	5309	

Urethane arm caps are available in black, sable or dove.



## 53L412U LOVESEAT, WOOD ARM, URETHANE CAP

W: 54" D: 32.5" H: 32.5" SW: 48" SD: 21" SH: 18.5" AH: 24" WT: 95 lb COM: 4.5 yd WT CAP: 650 lb

ZONE	B/COM	C	D	E	F	G	H	I	J	GENERAL INFORMATION
1	6267	6357	6443	6551	6731	6906	7086	7262	7442	MATERIAL: Maple
2	6422	6512	6598	6706	6886	7061	7241	7417	7597	MOIS. BARR: Included
3	6577	6667	6753	6861	7041	7216	7396	7572	7752	
4	6732	6822	6908	7016	7196	7371	7551	7727	7907	

Urethane arm caps are available in black, sable or dove.

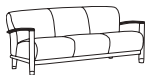

## 53L413U SOFA, WOOD ARM, URETHANE CAP

W: 76" D: 32.5" H: 32.5" SW: 72" SD: 21" SH: 18.5" AH: 24" WT: 128 lb COM: 6.25 yd WT CAP: 750 lb

ZONE	B/COM	C	D	E	F	G	H	I	J	GENERAL INFORMATION
1	7732	7857	7976	8126	8376	8620	8870	9113	9363	MATERIAL: Maple
2	7923	8048	8167	8317	8567	8811	9061	9304	9554	MOIS. BARR: Included
3	8114	8239	8358	8508	8758	9002	9252	9495	9745	
4	8304	8429	8548	8698	8948	9192	9442	9685	9935	

Urethane arm caps are available in black, sable or dove.

**Specify:**

- Product Number
- Wood Finish
- Urethane Cap Color
- Fabric Vendor, Pattern and Color

See pages 16 & 17 for material and finish options.

# Cove Recliners

## ARM CAP MODELS

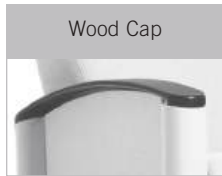

Specify finish.



Specify black, sable or dove.



Specify solid surface color.

## ARM OPTIONS



Specify right, left or both (as facing).



Transfer arm is only available with the straight back option.

## BACK OPTIONS



Black or silver.



Specify fabric.



## FEET OPTIONS



Black or silver.



## TABLES



Laminate\* \$618  
Thermoform \$618  
Solid Surface \$1233

Available right side only (as facing). Full-flip tables cannot be used with a foley-bag hook. Full flip table is 13.5"W x 19"D.



Laminate\* \$618  
Thermoform \$618  
Solid Surface \$1233

Available right side only (as facing). Half-flip table is 13.5"W x 13.25"D.



Laminate\*\* \$1330  
Thermoform \$1330  
Solid Surface \$2658

Specify right or left (as facing). Fold-down table is 12 5/8"W x 19 1/8"D.



\*Full and half-flip tables are available with a vinyl edge, specify black, white, brown, gray or almond.

\*\*Fold-down table, wood finished edge is standard and only option.

## ACCESSORIES



Specify right or left (as facing). Not available on transfer arm side when specified.



Available right side only (as facing).

# Cove Patient Recliners



## 53981 PATIENT RECLINER

W: 29.25" D: 34.75" H: 43" SW: 21.5" SD: 20.5" SH: 19" AH: 24.75" WT: 137 lb COM: 4.75 yd WT CAP: 500 lb

ZONE	B/COM	C	D	E	F	G	H	I	J	GENERAL INFORMATION
1	7048	7143	7233	7347	7537	7723	7913	8098	8288	MATERIAL: Varies
2	7222	7317	7407	7521	7711	7897	8087	8272	8462	MOIS. BARR: Included
3	7397	7492	7582	7696	7886	8072	8262	8447	8637	
4	7571	7666	7756	7870	8060	8246	8436	8621	8811	



## 53W981 PATIENT RECLINER, WIDE

W: 31.25" D: 34.75" H: 43" SW: 23.5" SD: 20.5" SH: 19" AH: 24.75" WT: 145 lb COM: 5 yd WT CAP: 500 lb

ZONE	B/COM	C	D	E	F	G	H	I	J	GENERAL INFORMATION
1	7661	7761	7856	7976	8176	8371	8571	8766	8966	MATERIAL: Varies
2	7851	7951	8046	8166	8366	8561	8761	8956	9156	MOIS. BARR: Included
3	8040	8140	8235	8355	8555	8750	8950	9145	9345	
4	8230	8330	8425	8545	8745	8940	9140	9335	9535	



## 53X981 PATIENT RECLINER, EXTRA WIDE

W: 35.25" D: 34.75" H: 43" SW: 27.5" SD: 20.5" SH: 19" AH: 24.75" WT: 161 lb COM: 5.75 yd WT CAP: 500 lb

ZONE	B/COM	C	D	E	F	G	H	I	J	GENERAL INFORMATION
1	8426	8541	8650	8788	9018	9243	9473	9697	9927	MATERIAL: Varies
2	8634	8749	8858	8996	9226	9451	9681	9905	10135	MOIS. BARR: Included
3	8843	8958	9067	9205	9435	9660	9890	10114	10344	
4	9051	9166	9275	9413	9643	9868	10098	10322	10552	

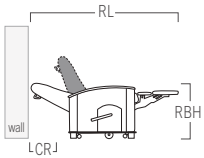

RL- Reclined length 69"

RBH- Reclined back height 31"

CR- Clearance required when placed against a wall is 24"

A 12" clearance is required from edge of chair when optional table is extended.

### Specify:

- Product Number
- Wood Finish
- Urethane Cap Color
- Laminate Vendor, Pattern and Color
- Solid Surface Color
- Fabric Vendor, Pattern and Color
- Recliner Options

See pages 16 & 17 for material and finish options.

# Cove Orthopedic Recliners



## 53H981 ORTHOPEDIC PATIENT RECLINER

W: 29.25" D: 34.75" H: 45" SW: 21.5" SD: 20.5" SH: 21" AH: 26.75" WT: 143 lb COM: 5 yd WT CAP: 500 lb

ZONE	B/COM	C	D	E	F	G	H	I	J	GENERAL INFORMATION
1	7546	7646	7741	7861	8061	8256	8456	8651	8851	MATERIAL: Varies MOIS. BARR: Included
2	7733	7833	7928	8048	8248	8443	8643	8838	9038	
3	7919	8019	8114	8234	8434	8629	8829	9024	9224	
4	8106	8206	8301	8421	8621	8816	9016	9211	9411	



## 53WH981 ORTHOPEDIC PATIENT RECLINER, WIDE

W: 31.25" D: 34.75" H: 45" SW: 23.5" SD: 20.5" SH: 21" AH: 26.75" WT: 151 lb COM: 5.25 yd WT CAP: 500 lb

ZONE	B/COM	C	D	E	F	G	H	I	J	GENERAL INFORMATION
1	8159	8264	8364	8490	8700	8905	9115	9319	9529	MATERIAL: Varies MOIS. BARR: Included
2	8361	8466	8566	8692	8902	9107	9317	9521	9731	
3	8563	8668	8768	8894	9104	9309	9519	9723	9933	
4	8765	8870	8970	9096	9306	9511	9721	9925	10135	



## 53XH981 ORTHOPEDIC PATIENT RECLINER, EXTRA WIDE

W: 35.25" D: 34.75" H: 45" SW: 27.5" SD: 20.5" SH: 21" AH: 26.75" WT: 167 lb COM: 6 yd WT CAP: 500 lb

ZONE	B/COM	C	D	E	F	G	H	I	J	GENERAL INFORMATION
1	8957	9077	9191	9335	9575	9809	10049	10283	10523	MATERIAL: Varies MOIS. BARR: Included
2	9179	9299	9413	9557	9797	10031	10271	10505	10745	
3	9400	9520	9634	9778	10018	10252	10492	10726	10966	
4	9622	9742	9856	10000	10240	10474	10714	10948	11188	

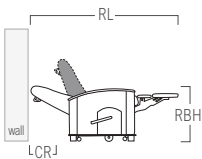

RL- Reclined length 73"

RBH- Reclined back height 32"

CR- Clearance required when placed against a wall is 24"

A 12" clearance is required from edge of chair when optional table is extended.

### Specify:

- Product Number
- Wood Finish
- Urethane Cap Color
- Laminate Vendor, Pattern and Color
- Solid Surface Color
- Fabric Vendor, Pattern and Color
- Recliner Options

See pages 16 & 17 for material and finish options.

# Cove Sleep Recliners



## 53981S SLEEP RECLINER

W: 29.25" D: 34.75" H: 43" SW: 21.5" SD: 20.5" SH: 19" AH: 24.75" WT: 139 lb COM: 4.75 yd WT CAP: 500 lb

ZONE	B/COM	C	D	E	F	G	H	I	J	GENERAL INFORMATION
1	7793	7888	7978	8092	8282	8468	8658	8843	9033	MATERIAL: Varies MOIS. BARR: Included
2	7986	8081	8171	8285	8475	8661	8851	9036	9226	
3	8179	8274	8364	8478	8668	8854	9044	9229	9419	
4	8372	8467	8557	8671	8861	9047	9237	9422	9612	



## 53W981S SLEEP RECLINER, WIDE

W: 31.25" D: 34.75" H: 43" SW: 23.5" SD: 20.5" SH: 19" AH: 24.75" WT: 147 lb COM: 5 yd WT CAP: 500 lb

ZONE	B/COM	C	D	E	F	G	H	I	J	GENERAL INFORMATION
1	8404	8504	8599	8719	8919	9114	9314	9509	9709	MATERIAL: Varies MOIS. BARR: Included
2	8612	8712	8807	8927	9127	9322	9522	9717	9917	
3	8820	8920	9015	9135	9335	9530	9730	9925	10125	
4	9028	9128	9223	9343	9543	9738	9938	10133	10333	

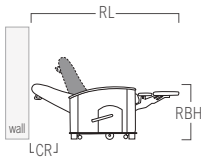

RL- Reclined length 73"

RBH- Reclined back height 32"

CR- Clearance required when placed against a wall is 24"

A 12" clearance is required from edge of chair when optional table is extended.

### Specify:

- Product Number
- Wood Finish
- Urethane Cap Color
- Laminate Vendor, Pattern and Color
- Solid Surface Color
- Fabric Vendor, Pattern and Color
- Recliner Options

See pages 16 & 17 for material and finish options.

# Cove Orthopedic/Sleep Recliners



## 53H981S ORTHOPEDIC SLEEP RECLINER

W: 29.25" D: 34.75" H: 45" SW: 21.5" SD: 20.5" SH: 21" AH: 26.75" WT: 148 lb COM: 5 yd WT CAP: 500 lb

ZONE	B/COM	C	D	E	F	G	H	I	J	GENERAL INFORMATION
1	8286	8386	8481	8601	8801	8996	9196	9391	9591	MATERIAL: Varies MOIS. BARR: Included
2	8491	8591	8686	8806	9006	9201	9401	9596	9796	
3	8696	8796	8891	9011	9211	9406	9606	9801	10001	
4	8901	9001	9096	9216	9416	9611	9811	10006	10206	



## 53WH981S ORTHOPEDIC SLEEP RECLINER, WIDE

W: 31.25" D: 34.75" H: 45" SW: 23.5" SD: 20.5" SH: 21" AH: 26.75" WT: 156 lb COM: 5.25 yd WT CAP: 500 lb

ZONE	B/COM	C	D	E	F	G	H	I	J	GENERAL INFORMATION
1	8900	9005	9105	9231	9441	9646	9856	10060	10270	MATERIAL: Varies MOIS. BARR: Included
2	9120	9225	9325	9451	9661	9866	10076	10280	10490	
3	9341	9446	9546	9672	9882	10087	10297	10501	10711	
4	9561	9666	9766	9892	10102	10307	10517	10721	10931	

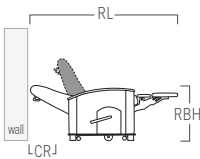

RL- Reclined length 73"

RBH- Reclined back height 32"

CR- Clearance required when placed against a wall is 24"

A 12" clearance is required from edge of chair when optional table is extended.

**Specify:**

- Product Number
- Wood Finish
- Urethane Cap Color
- Laminate Vendor, Pattern and Color
- Solid Surface Color
- Fabric Vendor, Pattern and Color
- Recliner Options

**See pages 16 & 17 for material and finish options.**

# Cove Trendelenburg Recliners



## 53981T TRENDELENBURG RECLINER

W: 29.25" D: 34.75" H: 43" SW: 21.5" SD: 20.5" SH: 19" AH: 24.75" WT: 145 lb COM: 4.75 yd WT CAP: 500 lb

ZONE	B/COM	C	D	E	F	G	H	I	J	GENERAL INFORMATION
1	8027	8122	8212	8326	8516	8702	8892	9077	9267	MATERIAL: Varies MOIS. BARR: Included
2	8226	8321	8411	8525	8715	8901	9091	9276	9466	
3	8425	8520	8610	8724	8914	9100	9290	9475	9665	
4	8623	8718	8808	8922	9112	9298	9488	9673	9863	



## 53W981T TRENDELENBURG RECLINER, WIDE

W: 31.25" D: 34.75" H: 43" SW: 23.5" SD: 20.5" SH: 19" AH: 24.75" WT: 153 lb COM: 5 yd WT CAP: 500 lb

ZONE	B/COM	C	D	E	F	G	H	I	J	GENERAL INFORMATION
1	8641	8741	8836	8956	9156	9351	9551	9746	9946	MATERIAL: Varies MOIS. BARR: Included
2	8855	8955	9050	9170	9370	9565	9765	9960	10160	
3	9069	9169	9264	9384	9584	9779	9979	10174	10374	
4	9283	9383	9478	9598	9798	9993	10193	10388	10588	

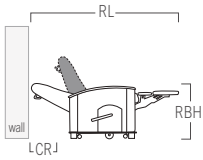

RL- Reclined length 73"

RBH- Reclined back height 27"

CR- Clearance required when placed against a wall is 21"

A 12" clearance is required from edge of chair when optional table is extended.

### Specify:

- Product Number
- Wood Finish
- Urethane Cap Color
- Laminate Vendor, Pattern and Color
- Solid Surface Color
- Fabric Vendor, Pattern and Color
- Recliner Options

See pages 16 & 17 for material and finish options.

# Dune Occasional Tables

---

## LEG OPTIONS

---



*Specify metal finish.*

## FREESTANDING TABLE EDGE OPTIONS

---



*Available in 7 colors to match metal finishes.*

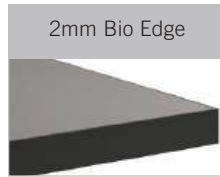

*Available in 7 colors to match metal finishes.*



*Available in 9 wood grain colors to match standard laminates.*



*Specify laminate color.*

# Dune Occasional Tables



## 225241820RE RECTANGULAR END TABLE, METAL, 24D 18W 20H

W: 18" D: 24" H: 20" WT: 23 lb

### GENERAL INFORMATION

TOP MATERIAL: Laminate  
BASE MATERIAL: Metal

Zone	1	2	3	4
	1510	1548	1586	1623

Table ships unassembled.

## 225242420SQ SQUARE END TABLE, METAL, 24D 24W 20H

W: 24" D: 24" H: 20" WT: 26 lb

### GENERAL INFORMATION

TOP MATERIAL: Laminate  
BASE MATERIAL: Metal

Zone	1	2	3	4
	1510	1548	1586	1623

Table ships unassembled.



## 225242420RD ROUND END TABLE, METAL, 24D 24W 20H

W: 24" D: 24" H: 20" WT: 26 lb

### GENERAL INFORMATION

TOP MATERIAL: Laminate  
BASE MATERIAL: Metal

Zone	1	2	3	4
	1510	1548	1586	1623

Table ships unassembled.

## 225244816RE RECTANGULAR COFFEE TABLE, METAL, 24D 48W 16H

W: 48" D: 24" H: 16" WT: 34 lb

### GENERAL INFORMATION

TOP MATERIAL: Laminate  
BASE MATERIAL: Metal

Zone	1	2	3	4
	1772	1816	1861	1905

Table ships unassembled.



## 225484816SQ SQUARE COFFEE TABLE, METAL, 48D 48W 16H

W: 48" D: 48" H: 16" WT: 54 lb

### GENERAL INFORMATION

TOP MATERIAL: Laminate  
BASE MATERIAL: Metal

Zone	1	2	3	4
	2624	2690	2755	2821

Table ships unassembled.

## 225484816RD ROUND COFFEE TABLE, METAL, 48D 48W 16H

W: 48" D: 48" H: 16" WT: 54 lb

### GENERAL INFORMATION

TOP MATERIAL: Laminate  
BASE MATERIAL: Metal

Zone	1	2	3	4
	2494	2556	2619	2681

Table ships unassembled.

- Specify:
- Product Number
  - Metal Finish
  - Edge Style & Finish
  - Laminate Vendor, Name & Number

See pages 16 & 17 for material and finish options.

# Dune Occasional Tables



## 224241820RE RECTANGULAR END TABLE, WOOD, 24D 18W 20H

### GENERAL INFORMATION

W: 18" D: 24" H: 20" WT: 21 lb

TOP MATERIAL: Laminate  
BASE MATERIAL: Wood and Metal

Zone	1	2	3	4
	2034	2085	2136	2187

Table ships unassembled.



## 224242420SQ SQUARE END TABLE, WOOD, 24D 24W 20H

### GENERAL INFORMATION

W: 24" D: 24" H: 20" WT: 24 lb

TOP MATERIAL: Laminate  
BASE MATERIAL: Wood and Metal

Zone	1	2	3	4
	2034	2085	2136	2187

Table ships unassembled.



## 224242420RD ROUND END TABLE, WOOD, 24D 24W 20H

### GENERAL INFORMATION

W: 24" D: 24" H: 20" WT: 24 lb

TOP MATERIAL: Laminate  
BASE MATERIAL: Wood and Metal

Zone	1	2	3	4
	2034	2085	2136	2187

Table ships unassembled.

## 224244816RE RECTANGULAR COFFEE TABLE, WOOD, 24D 48W 16H

### GENERAL INFORMATION

W: 48" D: 24" H: 16" WT: 32 lb

TOP MATERIAL: Laminate  
BASE MATERIAL: Wood and Metal

Zone	1	2	3	4
	2297	2354	2412	2469

Table ships unassembled.

## 224484816SQ SQUARE COFFEE TABLE, WOOD, 48D 48W 16H

### GENERAL INFORMATION

W: 48" D: 48" H: 16" WT: 52 lb

TOP MATERIAL: Laminate  
BASE MATERIAL: Wood and Metal

Zone	1	2	3	4
	3150	3229	3308	3386

Table ships unassembled.

## 224484816RD ROUND COFFEE TABLE, WOOD, 48D 48W 16H

### GENERAL INFORMATION

W: 48" D: 48" H: 16" WT: 52 lb

TOP MATERIAL: Laminate  
BASE MATERIAL: Wood and Metal

Zone	1	2	3	4
	3019	3094	3170	3245

Table ships unassembled.

#### Specify:

- Product Number
- Metal Finish
- Wood Finish
- Edge Style & Finish
- Laminate Vendor, Name & Number

See pages 16 & 17 for material and finish options.

## ARM CAP OPTIONS



*Specify solid surface color.*



\$237 2-Seat Tandem  
\$316 3-Seat Tandem  
*Specify thermoform finish.*



\$394 2-Seat Tandem  
\$525 3-Seat Tandem  
*Specify solid surface color. Full cap available in solid surface only. Not available on benches.*

## ARM OPTIONS



## MODULAR TABLE OPTIONS



*Standard. Specify thermoform finish. Not available on arm insert models.*



*Specify solid surface color. Not available on arm insert models.*

## ACCESSORIES



*One assembly required between each seat.*



*Available on single seat models only.*

# Hale Arm Chairs



## 6651121 CHAIR, 21" SEAT, METAL FRAME

W: 24"	D: 24.75"	H: 34"	SW: 21"	SD: 19"	SH: 18"	AH: 25"	WT: 35 lb	COM: 2 yd	WT CAP: 550 lb	
ZONE	B/COM	C	D	E	F	G	H	I	J	GENERAL INFORMATION
1	2027	2067	2105	2153	2233	2311	2391	2469	2549	MATERIAL: Metal
2	2077	2117	2155	2203	2283	2361	2441	2519	2599	MOIS. BARR: \$24
3	2127	2167	2205	2253	2333	2411	2491	2569	2649	
4	2177	2217	2255	2303	2383	2461	2541	2619	2699	

## 6651130 CHAIR, 30" SEAT, METAL FRAME

W: 33"	D: 24.75"	H: 34"	SW: 30"	SD: 19"	SH: 18"	AH: 25"	WT: 43 lb	COM: 2.75 yd	WT CAP: 750 lb	
ZONE	B/COM	C	D	E	F	G	H	I	J	GENERAL INFORMATION
1	2522	2577	2629	2695	2805	2913	3023	3130	3240	MATERIAL: Metal
2	2584	2639	2691	2757	2867	2975	3085	3192	3302	MOIS. BARR: \$33
3	2646	2701	2753	2819	2929	3037	3147	3254	3364	
4	2708	2763	2815	2881	2991	3099	3209	3316	3426	

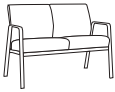

## 665112 LOVESEAT, METAL FRAME

W: 45"	D: 24.75"	H: 34"	SW: 21"	SD: 19"	SH: 18"	AH: 25"	WT: 71 lb	COM: 3.25 yd	WT CAP: 750 lb	
ZONE	B/COM	C	D	E	F	G	H	I	J	GENERAL INFORMATION
1	3751	3816	3878	3956	4086	4213	4343	4469	4599	MATERIAL: Metal
2	3843	3908	3970	4048	4178	4305	4435	4561	4691	MOIS. BARR: \$39
3	3936	4001	4063	4141	4271	4398	4528	4654	4784	
4	4028	4093	4155	4233	4363	4490	4620	4746	4876	

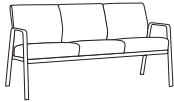

## 665113 SOFA, METAL FRAME

W: 66"	D: 24.75"	H: 34"	SW: 21"	SD: 19"	SH: 18"	AH: 25"	WT: 103 lb	COM: 4.75 yd	WT CAP: 750 lb	
ZONE	B/COM	C	D	E	F	G	H	I	J	GENERAL INFORMATION
1	5487	5582	5672	5786	5976	6162	6352	6537	6727	MATERIAL: Metal
2	5622	5717	5807	5921	6111	6297	6487	6672	6862	MOIS. BARR: \$57
3	5758	5853	5943	6057	6247	6433	6623	6808	6998	
4	5893	5988	6078	6192	6382	6568	6758	6943	7133	

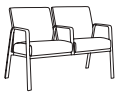

## 66510-2T 2 SEAT TANDEM, SHORT CENTER ARMS, METAL FRAME

W: 46.5"	D: 24.75"	H: 34"	SW: 21"	SD: 19"	SH: 18"	AH: 25"	WT: 73 lb	COM: 3.25 yd	WT CAP: 750 lb	
ZONE	B/COM	C	D	E	F	G	H	I	J	GENERAL INFORMATION
1	3946	4011	4073	4151	4281	4408	4538	4664	4794	MATERIAL: Metal
2	4043	4108	4170	4248	4378	4505	4635	4761	4891	MOIS. BARR: \$39
3	4141	4206	4268	4346	4476	4603	4733	4859	4989	
4	4238	4303	4365	4443	4573	4700	4830	4956	5086	

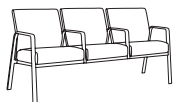

## 66510-3T 3 SEAT TANDEM, SHORT CENTER ARMS, METAL FRAME

W: 69"	D: 24.75"	H: 34"	SW: 21"	SD: 19"	SH: 18"	AH: 25"	WT: 106 lb	COM: 4.75 yd	WT CAP: 750 lb	
ZONE	B/COM	C	D	E	F	G	H	I	J	GENERAL INFORMATION
1	5871	5966	6056	6170	6360	6546	6736	6921	7111	MATERIAL: Metal
2	6016	6111	6201	6315	6505	6691	6881	7066	7256	MOIS. BARR: \$57
3	6161	6256	6346	6460	6650	6836	7026	7211	7401	
4	6306	6401	6491	6605	6795	6981	7171	7356	7546	

**Specify:**

- Product Number
- Metal Finish
- Fabric Vendor, Pattern and Color

See pages 16 & 17 for material and finish options.

# Hale Arm Chairs



## 6652121 CHAIR, 21" SEAT, ARM INSERT, METAL FRAME

W: 24" D: 24.75" H: 34" SW: 21" SD: 19" SH: 18" AH: 25" WT: 37 lb COM: 2.5 yd WT CAP: 550 lb

ZONE	B/COM	C	D	E	F	G	H	I	J	GENERAL INFORMATION
1	2611	2661	2709	2769	2869	2966	3066	3164	3264	MATERIAL: Metal MOIS. BARR: \$30
2	2675	2725	2773	2833	2933	3030	3130	3228	3328	
3	2740	2790	2838	2898	2998	3095	3195	3293	3393	
4	2804	2854	2902	2962	3062	3159	3259	3357	3457	

## 6652130 CHAIR, 30" SEAT, ARM INSERT, METAL FRAME

W: 33" D: 24.75" H: 34" SW: 30" SD: 19" SH: 18" AH: 25" WT: 45 lb COM: 2.75 yd WT CAP: 750 lb

ZONE	B/COM	C	D	E	F	G	H	I	J	GENERAL INFORMATION
1	3109	3164	3216	3282	3392	3500	3610	3717	3827	MATERIAL: Metal MOIS. BARR: \$33
2	3186	3241	3293	3359	3469	3577	3687	3794	3904	
3	3262	3317	3369	3435	3545	3653	3763	3870	3980	
4	3339	3394	3446	3512	3622	3730	3840	3947	4057	

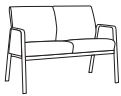

## 665212 LOVESEAT, ARM INSERT, METAL FRAME

W: 45" D: 24.75" H: 34" SW: 21" SD: 19" SH: 18" AH: 25" WT: 73 lb COM: 3.75 yd WT CAP: 750 lb

ZONE	B/COM	C	D	E	F	G	H	I	J	GENERAL INFORMATION
1	4578	4653	4724	4814	4964	5111	5261	5407	5557	MATERIAL: Metal MOIS. BARR: \$45
2	4691	4766	4837	4927	5077	5224	5374	5520	5670	
3	4804	4879	4950	5040	5190	5337	5487	5633	5783	
4	4917	4992	5063	5153	5303	5450	5600	5746	5896	

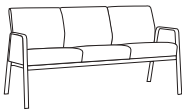

## 665213 SOFA, ARM INSERT, METAL FRAME

W: 66" D: 24.75" H: 34" SW: 21" SD: 19" SH: 18" AH: 25" WT: 105 lb COM: 5 yd WT CAP: 750 lb

ZONE	B/COM	C	D	E	F	G	H	I	J	GENERAL INFORMATION
1	6567	6667	6762	6882	7082	7277	7477	7672	7872	MATERIAL: Metal MOIS. BARR: \$60
2	6729	6829	6924	7044	7244	7439	7639	7834	8034	
3	6891	6991	7086	7206	7406	7601	7801	7996	8196	
4	7054	7154	7249	7369	7569	7764	7964	8159	8359	



## 66520-2T 2 SEAT TANDEM, SHORT CENTER ARMS, ARM INSERT METAL FRAME

W: 46.5" D: 24.75" H: 34" SW: 21" SD: 19" SH: 18" AH: 25" WT: 76 lb COM: 4 yd WT CAP: 750 lb

ZONE	B/COM	C	D	E	F	G	H	I	J	GENERAL INFORMATION
1	4782	4862	4938	5034	5194	5350	5510	5666	5826	MATERIAL: Metal MOIS. BARR: \$48
2	4900	4980	5056	5152	5312	5468	5628	5784	5944	
3	5018	5098	5174	5270	5430	5586	5746	5902	6062	
4	5136	5216	5292	5388	5548	5704	5864	6020	6180	

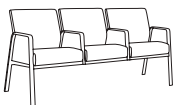

## 66520-3T 3 SEAT TANDEM, SHORT CENTER ARMS, ARM INSERT METAL FRAME

W: 69" D: 24.75" H: 34" SW: 21" SD: 19" SH: 18" AH: 25" WT: 110 lb COM: 5.5 yd WT CAP: 750 lb

ZONE	B/COM	C	D	E	F	G	H	I	J	GENERAL INFORMATION
1	6949	7059	7164	7296	7516	7730	7950	8165	8385	MATERIAL: Metal MOIS. BARR: \$66
2	7121	7231	7336	7468	7688	7902	8122	8337	8557	
3	7292	7402	7507	7639	7859	8073	8293	8508	8728	
4	7464	7574	7679	7811	8031	8245	8465	8680	8900	

- Specify:
- Product Number
  - Metal Finish
  - Fabric Vendor, Pattern and Color

See pages 16 & 17 for material and finish options.

# Hale Benches

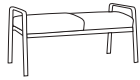

## 665192 2 SEAT BENCH, METAL FRAME

W: 45.75" D: 21.5" H: 22" SW: 21" SD: 21" SH: 18" AH: 22" WT: 56 lb COM: 2 yd WT CAP: 750 lb

ZONE	B/COM	C	D	E	F	G	H	I	J	GENERAL INFORMATION
1	3259	3299	3337	3385	3465	3543	3623	3701	3781	MATERIAL: Metal MOIS. BARR: \$24
2	3340	3380	3418	3466	3546	3624	3704	3782	3862	
3	3420	3460	3498	3546	3626	3704	3784	3862	3942	
4	3501	3541	3579	3627	3707	3785	3865	3943	4023	

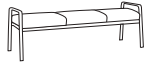

## 665193 3 SEAT BENCH, METAL FRAME

W: 67.5" D: 21.5" H: 22" SW: 21" SD: 21" SH: 18" AH: 22" WT: 78 lb COM: 2.25 yd WT CAP: 750 lb

ZONE	B/COM	C	D	E	F	G	H	I	J	GENERAL INFORMATION
1	4250	4295	4338	4392	4482	4570	4660	4747	4837	MATERIAL: Metal MOIS. BARR: \$27
2	4355	4400	4443	4497	4587	4675	4765	4852	4942	
3	4461	4506	4549	4603	4693	4781	4871	4958	5048	
4	4566	4611	4654	4708	4798	4886	4976	5063	5153	

**Specify:**

- Product Number
- Metal Finish
- Fabric Vendor, Pattern and Color

**See pages 16 & 17 for material and finish options.**

# Hale Patient Chairs



## 6651721 PATIENT CHAIR, 21" SEAT, METAL FRAME, HIGH BACK

W: 24" D: 24.75" H: 43.75" SW: 21" SD: 19" SH: 18" AH: 25" WT: 40 lb COM: 2.25 yd WT CAP: 550 lb

ZONE	B/COM	C	D	E	F	G	H	I	J	GENERAL INFORMATION
1	2277	2322	2365	2419	2509	2597	2687	2774	2864	MATERIAL: Metal MOIS. BARR: \$27
2	2333	2378	2421	2475	2565	2653	2743	2830	2920	
3	2389	2434	2477	2531	2621	2709	2799	2886	2976	
4	2445	2490	2533	2587	2677	2765	2855	2942	3032	

## 6651730 PATIENT CHAIR, 30" SEAT, METAL FRAME, HIGH BACK

W: 33" D: 24.75" H: 43.75" SW: 30" SD: 19" SH: 18" AH: 25" WT: 47 lb COM: 3.25 yd WT CAP: 750 lb

ZONE	B/COM	C	D	E	F	G	H	I	J	GENERAL INFORMATION
1	2772	2837	2899	2977	3107	3234	3364	3490	3620	MATERIAL: Metal MOIS. BARR: \$39
2	2840	2905	2967	3045	3175	3302	3432	3558	3688	
3	2908	2973	3035	3113	3243	3370	3500	3626	3756	
4	2976	3041	3103	3181	3311	3438	3568	3694	3824	



## 6652721 PATIENT CHAIR, 21" SEAT, ARM INSERT, METAL FRAME HIGH BACK

W: 24" D: 24.75" H: 43.75" SW: 21" SD: 19" SH: 18" AH: 25" WT: 40 lb COM: 2.75 yd WT CAP: 550 lb

ZONE	B/COM	C	D	E	F	G	H	I	J	GENERAL INFORMATION
1	2859	2914	2966	3032	3142	3250	3360	3467	3577	MATERIAL: Metal MOIS. BARR: \$33
2	2929	2984	3036	3102	3212	3320	3430	3537	3647	
3	3000	3055	3107	3173	3283	3391	3501	3608	3718	
4	3070	3125	3177	3243	3353	3461	3571	3678	3788	

## 6652730 PATIENT CHAIR, 30" SEAT, ARM INSERT, METAL FRAME HIGH BACK

W: 33" D: 24.75" H: 43.75" SW: 30" SD: 19" SH: 18" AH: 25" WT: 49 lb COM: 3.25 yd WT CAP: 750 lb

ZONE	B/COM	C	D	E	F	G	H	I	J	GENERAL INFORMATION
1	3355	3420	3482	3560	3690	3817	3947	4073	4203	MATERIAL: Metal MOIS. BARR: \$39
2	3438	3503	3565	3643	3773	3900	4030	4156	4286	
3	3520	3585	3647	3725	3855	3982	4112	4238	4368	
4	3603	3668	3730	3808	3938	4065	4195	4321	4451	



## 6650100 OTTOMAN, 13" HEIGHT, METAL FRAME

W: 18.5" D: 17" H: 13" SW: - SD: - SH: - AH: - WT: 11.5 lb COM: 1.5 yd WT CAP: 300 lb

ZONE	B/COM	C	D	E	F	G	H	I	J	GENERAL INFORMATION
1	1270	1300	1329	1365	1425	1483	1543	1602	1662	MATERIAL: Metal MOIS. BARR: \$18
2	1301	1331	1360	1396	1456	1514	1574	1633	1693	
3	1332	1362	1391	1427	1487	1545	1605	1664	1724	
4	1363	1393	1422	1458	1518	1576	1636	1695	1755	

**Specify:**

- Product Number
- Metal Finish
- Fabric Vendor, Pattern and Color

See pages 16 & 17 for material and finish options.

# Hale Motion Chairs



## 66517M21 MOTION CHAIR, 21" SEAT, METAL FRAME

W: 24.75" D: 24.75" H: 45" SW: 21" SD: 19" SH: 18.5" AH: 25" WT: 64 lb COM: 2.25 yd WT CAP: 550 lb

ZONE	B/COM	C	D	E	F	G	H	I	J	GENERAL INFORMATION
1	3045	3090	3133	3187	3277	3365	3455	3542	3632	MATERIAL: Metal MOIS. BARR: \$27
2	3120	3165	3208	3262	3352	3440	3530	3617	3707	
3	3195	3240	3283	3337	3427	3515	3605	3692	3782	
4	3271	3316	3359	3413	3503	3591	3681	3768	3858	

## 66517M30 MOTION CHAIR, 30" SEAT, METAL FRAME

W: 33.75" D: 24.75" H: 45" SW: 30" SD: 19" SH: 18.5" AH: 25" WT: 75 lb COM: 3.25 yd WT CAP: 750 lb

ZONE	B/COM	C	D	E	F	G	H	I	J	GENERAL INFORMATION
1	3520	3585	3647	3725	3855	3982	4112	4238	4368	MATERIAL: Metal MOIS. BARR: \$39
2	3607	3672	3734	3812	3942	4069	4199	4325	4455	
3	3693	3758	3820	3898	4028	4155	4285	4411	4541	
4	3780	3845	3907	3985	4115	4242	4372	4498	4628	



## 6650100M OTTOMAN, 11" HEIGHT, METAL FRAME, MOTION

W: 18.5" D: 17" H: 11" SW: - SD: - SH: - AH: - WT: 10.5 lb COM: 1.5 yd WT CAP: 300 lb

ZONE	B/COM	C	D	E	F	G	H	I	J	GENERAL INFORMATION
1	1190	1220	1249	1285	1345	1403	1463	1522	1582	MATERIAL: Metal MOIS. BARR: \$18
2	1219	1249	1278	1314	1374	1432	1492	1551	1611	
3	1248	1278	1307	1343	1403	1461	1521	1580	1640	
4	1277	1307	1336	1372	1432	1490	1550	1609	1669	

Specify:

- Product Number
- Metal Finish
- Fabric Vendor, Pattern and Color

See pages 16 & 17 for material and finish options.

# Hale Easy Access Chairs



## 66511H21 EASY ACCESS CHAIR, 21" SEAT, METAL FRAME

W: 24" D: 25.5" H: 40.5" SW: 21" SD: 19" SH: 24.5" AH: 31.5" WT: 47 lb COM: 2 yd WT CAP: 550 lb

ZONE	B/COM	C	D	E	F	G	H	I	J	GENERAL INFORMATION
1	2806	2846	2884	2932	3012	3090	3170	3248	3328	MATERIAL: Metal MOIS. BARR: \$24
2	2875	2915	2953	3001	3081	3159	3239	3317	3397	
3	2945	2985	3023	3071	3151	3229	3309	3387	3467	
4	3014	3054	3092	3140	3220	3298	3378	3456	3536	

## 66511H30 EASY ACCESS CHAIR, 30" SEAT, METAL FRAME

W: 33" D: 25.5" H: 40.5" SW: 30" SD: 19" SH: 24.5" AH: 31.5" WT: 70 lb COM: 2.75 yd WT CAP: 750 lb

ZONE	B/COM	C	D	E	F	G	H	I	J	GENERAL INFORMATION
1	3123	3178	3230	3296	3406	3514	3624	3731	3841	MATERIAL: Metal MOIS. BARR: \$33
2	3200	3255	3307	3373	3483	3591	3701	3808	3918	
3	3277	3332	3384	3450	3560	3668	3778	3885	3995	
4	3354	3409	3461	3527	3637	3745	3855	3962	4072	



## 66521H21 EASY ACCESS CHAIR, 21" SEAT, ARM INSERT, METAL FRAME

W: 24" D: 25.5" H: 40.5" SW: 21" SD: 19" SH: 24.5" AH: 31.5" WT: 49 lb COM: 2.5 yd WT CAP: 550 lb

ZONE	B/COM	C	D	E	F	G	H	I	J	GENERAL INFORMATION
1	3369	3419	3467	3527	3627	3724	3824	3922	4022	MATERIAL: Metal MOIS. BARR: \$30
2	3452	3502	3550	3610	3710	3807	3907	4005	4105	
3	3535	3585	3633	3693	3793	3890	3990	4088	4188	
4	3619	3669	3717	3777	3877	3974	4074	4172	4272	

## 66521H30 EASY ACCESS CHAIR, 30" SEAT, ARM INSERT, METAL FRAME

W: 33" D: 25.5" H: 40.5" SW: 30" SD: 19" SH: 24.5" AH: 31.5" WT: 72 lb COM: 2.75 yd WT CAP: 750 lb

ZONE	B/COM	C	D	E	F	G	H	I	J	GENERAL INFORMATION
1	3682	3737	3789	3855	3965	4073	4183	4290	4400	MATERIAL: Metal MOIS. BARR: \$33
2	3773	3828	3880	3946	4056	4164	4274	4381	4491	
3	3864	3919	3971	4037	4147	4255	4365	4472	4582	
4	3955	4010	4062	4128	4238	4346	4456	4563	4673	

**Specify:**

- Product Number
- Metal Finish
- Fabric Vendor,  
Pattern and Color

**See pages 16 & 17  
for material and finish  
options.**

# Hale Modular Tables

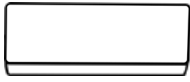

## 66500-ST SPANNER TABLE, MODULAR

W: 22" D: 18" H: 14.5" WT: 23 lb

Zone	1	2	3	4
	965	989	1013	1037

### GENERAL INFORMATION

MATERIAL: Metal  
MOIS BARR: -

Not available with arm insert models. Specify thermoform or solid surface. Thermoform is standard. See beginning of section for details.



## 66500-ETR END TABLE, MODULAR, RIGHT

W: 22" D: 18" H: 14.5" WT: 24 lb

Zone	1	2	3	4
	1189	1219	1248	1278

### GENERAL INFORMATION

MATERIAL: Metal  
MOIS BARR: -

Not available with arm insert models. Specify thermoform or solid surface. Thermoform is standard. See beginning of section for details. Modular table orders must include a layout to ensure proper configuration.



## 66500-ETL END TABLE, MODULAR, LEFT

W: 22" D: 18" H: 14.5" WT: 24 lb

Zone	1	2	3	4
	1189	1219	1248	1278

### GENERAL INFORMATION

MATERIAL: Metal  
MOIS BARR: -

Not available with arm insert models. Specify thermoform or solid surface. Thermoform is standard. See beginning of section for details. Modular table orders must include a layout to ensure proper configuration.

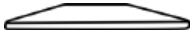

## 66500-CTAO CORNER TABLE, ANGLED, OUTSIDE MODULAR

W: 34" D: 12" H: 14.5" WT: 20 lb

Zone	1	2	3	4
	1436	1472	1508	1544

### GENERAL INFORMATION

MATERIAL: Metal  
MOIS BARR: -

Not available with arm insert models. Specify thermoform or solid surface. Thermoform is standard. See beginning of section for details. Modular table orders must include a layout to ensure proper configuration.



## 66500-CT CORNER TABLE, MODULAR

W: 28.5" D: 28.5" H: 14.5" WT: 39 lb

Zone	1	2	3	4
	1436	1472	1508	1544

### GENERAL INFORMATION

MATERIAL: Metal  
MOIS BARR: -

Not available with arm insert models. Specify thermoform or solid surface. Thermoform is standard. See beginning of section for details. Modular table orders must include a layout to ensure proper configuration.



## 66500-CTAI CORNER TABLE, ANGLED, INSIDE MODULAR

W: 40" D: 22.5" H: 14.5" WT: 23 lb

Zone	1	2	3	4
	1314	1347	1380	1413

### GENERAL INFORMATION

MATERIAL: Metal  
MOIS BARR: -

Not available with arm insert models. Specify thermoform or solid surface. Thermoform is standard. See beginning of section for details. Modular table orders must include a layout to ensure proper configuration.

#### Specify:

- Product Number
- Thermoform Finish
- Solid Surface Name and Number

See pages 16 & 17 for material and finish options.

## ARM OPTIONS



Standard.



\$458  
10322 (set of 3)  
  
\$610  
10312CT, 10323 (set of 4)  
Specify wood finish (Beech).



\$690  
10312CT, 10322 (set of 3)  
  
\$920  
10312CT, 10323 (set of 4)  
Specify solid surface color.

## TABLE OPTIONS



Standard. Specify wood finish (Beech).



10312CT, 10392CT  
Specify solid surface color.



10312WT (pair)  
Specify solid surface color.

## POWER OPTIONS



Specify white or black.  
Power outlet is mounted on the left hand facing side on single seat chairs 10311 and 1031130, all others are mounted in the center.

# Latitude



## 10311 CHAIR

W: 27" D: 28.75" H: 32" SW: 22" SD: 20.5" SH: 18.75" AH: 24" WT: 65 lb COM: 3 yd WT CAP: 550 lb

ZONE	B/COM	C	D	E	F	G	H	I	J	GENERAL INFORMATION
1	3466	3521	3573	3639	3749	3857	3967	4074	4184	MATERIAL: Varies
2	3552	3607	3659	3725	3835	3943	4053	4160	4270	MOIS. BARR: Included
3	3637	3692	3744	3810	3920	4028	4138	4245	4355	
4	3723	3778	3830	3896	4006	4114	4224	4331	4441	

## 1031130 CHAIR, WIDE

W: 35" D: 28.75" H: 32" SW: 30" SD: 20.5" SH: 18.75" AH: 24" WT: 65 lb COM: 3.25 yd WT CAP: 550 lb

ZONE	B/COM	C	D	E	F	G	H	I	J	GENERAL INFORMATION
1	4297	4362	4424	4502	4632	4759	4889	5015	5145	MATERIAL: Varies
2	4403	4468	4530	4608	4738	4865	4995	5121	5251	MOIS. BARR: Included
3	4509	4574	4636	4714	4844	4971	5101	5227	5357	
4	4615	4680	4742	4820	4950	5077	5207	5333	5463	



## 10312 LOVESEAT

W: 49" D: 28.75" H: 32" SW: 22" SD: 20.5" SH: 18.75" AH: 24" WT: 86 lb COM: 4 yd WT CAP: 750 lb

ZONE	B/COM	C	D	E	F	G	H	I	J	GENERAL INFORMATION
1	5012	5092	5168	5264	5424	5580	5740	5896	6056	MATERIAL: Varies
2	5136	5216	5292	5388	5548	5704	5864	6020	6180	MOIS. BARR: Included
3	5259	5339	5415	5511	5671	5827	5987	6143	6303	
4	5383	5463	5539	5635	5795	5951	6111	6267	6427	

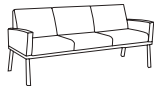

## 10313 SOFA

W: 71" D: 28.75" H: 32" SW: 22" SD: 20.5" SH: 18.75" AH: 24" WT: 107 lb COM: 5.25 yd WT CAP: 750 lb

ZONE	B/COM	C	D	E	F	G	H	I	J	GENERAL INFORMATION
1	6091	6196	6296	6422	6632	6837	7047	7251	7461	MATERIAL: Varies
2	6241	6346	6446	6572	6782	6987	7197	7401	7611	MOIS. BARR: Included
3	6391	6496	6596	6722	6932	7137	7347	7551	7761	
4	6542	6647	6747	6873	7083	7288	7498	7702	7912	



## 10322 LOVESEAT, CENTER ARM

W: 51.5" D: 28.75" H: 32" SW: 22" SD: 20.5" SH: 18.75" AH: 24" WT: 86 lb COM: 4.5 yd WT CAP: 750 lb

ZONE	B/COM	C	D	E	F	G	H	I	J	GENERAL INFORMATION
1	5320	5410	5496	5604	5784	5959	6139	6315	6495	MATERIAL: Varies
2	5451	5541	5627	5735	5915	6090	6270	6446	6626	MOIS. BARR: Included
3	5582	5672	5758	5866	6046	6221	6401	6577	6757	
4	5714	5804	5890	5998	6178	6353	6533	6709	6889	

## 10323 SOFA, CENTER ARM

W: 76" D: 28.75" H: 32" SW: 22" SD: 20.5" SH: 18.75" AH: 24" WT: 107 lb COM: 6.25 yd WT CAP: 750 lb

ZONE	B/COM	C	D	E	F	G	H	I	J	GENERAL INFORMATION
1	6891	7016	7135	7285	7535	7779	8029	8272	8522	MATERIAL: Varies
2	7061	7186	7305	7455	7705	7949	8199	8442	8692	MOIS. BARR: Included
3	7231	7356	7475	7625	7875	8119	8369	8612	8862	
4	7400	7525	7644	7794	8044	8288	8538	8781	9031	

**Specify:**

- Product Number
- Wood Finish
- Fabric Vendor, Pattern and Color
- Solid Surface Name and Number

**See pages 16 & 17 for material and finish options.**



## 10312CT 2 SEAT, CENTER TABLE

W: 71" D: 28.75" H: 32" SW: 22" SD: 20.5" SH: 18.75" AH: 24" WT: 126 COM: 5 yd WT CAP: 750 lb

ZONE	B/COM	C	D	E	F	G	H	I	J	GENERAL INFORMATION
1	6083	6183	6278	6398	6598	6793	6993	7188	7388	MATERIAL: Varies MOIS. BARR: Included
2	6233	6333	6428	6548	6748	6943	7143	7338	7538	
3	6383	6483	6578	6698	6898	7093	7293	7488	7688	
4	6533	6633	6728	6848	7048	7243	7443	7638	7838	



## 10312WT LOVESEAT, WING TABLES

W: 71" D: 28.75" H: 32" SW: 22" SD: 20.5" SH: 18.75" AH: 24" WT: 104 lb COM: 4 yd WT CAP: 750 lb

ZONE	B/COM	C	D	E	F	G	H	I	J	GENERAL INFORMATION
1	5784	5864	5940	6036	6196	6352	6512	6668	6828	MATERIAL: Varies MOIS. BARR: Included
2	5927	6007	6083	6179	6339	6495	6655	6811	6971	
3	6070	6150	6226	6322	6482	6638	6798	6954	7114	
4	6213	6293	6369	6465	6625	6781	6941	7097	7257	

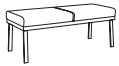

## 10392 2-SEAT BENCH

W: 43.5" D: 17.75" H: 17.5" SW: 22" SD: 18.75" SH: 17.5" AH: - WT: 104 lb COM: 1.75 yd WT CAP: 750 lb

ZONE	B/COM	C	D	E	F	G	H	I	J	GENERAL INFORMATION
1	4223	4258	4291	4333	4403	4472	4542	4610	4680	MATERIAL: Metal MOIS. BARR: Included
2	4328	4363	4396	4438	4508	4577	4647	4715	4785	
3	4433	4468	4501	4543	4613	4682	4752	4820	4890	
4	4538	4573	4606	4648	4718	4787	4857	4925	4995	

## 10393 3-SEAT BENCH

W: 65.5" D: 17.75" H: 17.5" SW: 22" SD: 18.75" SH: 17.5" AH: - WT: 104 lb COM: 2.75 yd WT CAP: 750 lb

ZONE	B/COM	C	D	E	F	G	H	I	J	GENERAL INFORMATION
1	5115	5170	5222	5288	5398	5506	5616	5723	5833	MATERIAL: Metal MOIS. BARR: Included
2	5242	5297	5349	5415	5525	5633	5743	5850	5960	
3	5369	5424	5476	5542	5652	5760	5870	5977	6087	
4	5495	5550	5602	5668	5778	5886	5996	6103	6213	

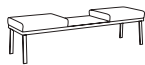

## 10392CT 2-SEAT BENCH, CENTER TABLE

W: 65.5" D: 17.75" H: 17.5" SW: 22" SD: 18.75" SH: 7.5" AH: - WT: 104 lb COM: 1.75 yd WT CAP: 750 lb

ZONE	B/COM	C	D	E	F	G	H	I	J	GENERAL INFORMATION
1	5111	5146	5179	5221	5291	5360	5430	5498	5568	MATERIAL: Varies MOIS. BARR: Included
2	5238	5273	5306	5348	5418	5487	5557	5625	5695	
3	5365	5400	5433	5475	5545	5614	5684	5752	5822	
4	5492	5527	5560	5602	5672	5741	5811	5879	5949	

Specify:

- Product Number
- Wood Finish
- Fabric Vendor, Pattern and Color
- Solid Surface Name and Number

See pages 16 & 17 for material and finish options.



## 7324001 CHAIR, WOOD ARM, LOW BACK

W: 24"	D: 25.5"	H: 33"	SW: 20"	SD: 18.75"	SH: 18"	AH: 25.75"	WT: 27 lb	COM: 1.5 yd	WT CAP: 300 lb	
ZONE	B/COM	C	D	E	F	G	H	I	J	GENERAL INFORMATION
1	1554	1584	1613	1649	1709	1767	1827	1886	1946	MATERIAL: Beech MOIS. BARR: \$18
2	1592	1622	1651	1687	1747	1805	1865	1924	1984	
3	1630	1660	1689	1725	1785	1843	1903	1962	2022	
4	1669	1699	1728	1764	1824	1882	1942	2001	2061	



## 7324002 CHAIR, WOOD ARM, MID BACK

W: 24"	D: 25.5"	H: 39"	SW: 20"	SD: 18.75"	SH: 18"	AH: 25.75"	WT: 30 lb	COM: 1.5 yd	WT CAP: 300 lb	
ZONE	B/COM	C	D	E	F	G	H	I	J	GENERAL INFORMATION
1	1662	1692	1721	1757	1817	1875	1935	1994	2054	MATERIAL: Beech MOIS. BARR: \$18
2	1703	1733	1762	1798	1858	1916	1976	2035	2095	
3	1744	1774	1803	1839	1899	1957	2017	2076	2136	
4	1785	1815	1844	1880	1940	1998	2058	2117	2177	

### Accessories

#### URETHANE ARM CAPS

\$218      2 Arms      Available in black, sable or dove.

#### Specify:

- Product Number
- Wood Finish
- Urethane Finish
- Fabric Vendor, Pattern and Color

See pages 16 & 17 for material and finish options.

# Laurelwood Patient and Motion



## 7324003 PATIENT CHAIR, WOOD ARM, HIGH BACK

W: 24" D: 25.5" H: 43" SW: 20" SD: 18.75" SH: 18" AH: 25.75" WT: 32 lb COM: 2.2 yd WT CAP: 300 lb

ZONE	B/COM	C	D	E	F	G	H	I	J	GENERAL INFORMATION
1	1800	1844	1886	1939	2027	2113	2201	2286	2374	MATERIAL: Beech MOIS. BARR: \$26
2	1844	1888	1930	1983	2071	2157	2245	2330	2418	
3	1888	1932	1974	2027	2115	2201	2289	2374	2462	
4	1932	1976	2018	2071	2159	2245	2333	2418	2506	



## 7324007 MOTION CHAIR, WOOD ARM, MID BACK

W: 25" D: 26.5" H: 39" SW: 20.25" SD: 18.75" SH: 18" AH: 25.75" WT: 49 lb COM: 2.2 yd WT CAP: 300 lb

ZONE	B/COM	C	D	E	F	G	H	I	J	GENERAL INFORMATION
1	2663	2707	2749	2802	2890	2976	3064	3149	3237	MATERIAL: Beech MOIS. BARR: \$26
2	2729	2773	2815	2868	2956	3042	3130	3215	3303	
3	2794	2838	2880	2933	3021	3107	3195	3280	3368	
4	2860	2904	2946	2999	3087	3173	3261	3346	3434	

Leg extensions are not available on motion chairs. Casters (7144002) are available on rear legs only. Casters must be locking. Non-skid slides are provided on the front legs.



## 7324008 MOTION PATIENT CHAIR, WOOD ARM, HIGH BACK

W: 25" D: 26.5" H: 45" SW: 20.25" SD: 18.25" SH: 18" AH: 25.75" WT: 51 lb COM: 2.2 yd WT CAP: 300 lb

ZONE	B/COM	C	D	E	F	G	H	I	J	GENERAL INFORMATION
1	2744	2788	2830	2883	2971	3057	3145	3230	3318	MATERIAL: Beech MOIS. BARR: \$26
2	2812	2856	2898	2951	3039	3125	3213	3298	3386	
3	2879	2923	2965	3018	3106	3192	3280	3365	3453	
4	2947	2991	3033	3086	3174	3260	3348	3433	3521	

Leg extensions are not available on motion chairs. Casters (7144002) are available on rear legs only. Casters must be locking. Non-skid slides are provided on the front legs.



## 7024007 OTTOMAN, 10" HEIGHT

W: 19" D: 16" H: 10" SW: - SD: - SH: - AH: - WT: 9 lb COM: .4 yd WT CAP: 300 lb

ZONE	B/COM	C	D	E	F	G	H	I	J	GENERAL INFORMATION
1	1052	1060	1068	1078	1094	1109	1125	1141	1157	MATERIAL: Beech MOIS. BARR: \$5
2	1078	1086	1094	1104	1120	1135	1151	1167	1183	
3	1104	1112	1120	1130	1146	1161	1177	1193	1209	
4	1130	1138	1146	1156	1172	1187	1203	1219	1235	



## 7024008 OTTOMAN, 18" HEIGHT

W: 19" D: 16.75" H: 18" SW: - SD: - SH: - AH: - WT: 15 lb COM: .4 yd WT CAP: 300 lb

ZONE	B/COM	C	D	E	F	G	H	I	J	GENERAL INFORMATION
1	1052	1060	1068	1078	1094	1109	1125	1141	1157	MATERIAL: Beech MOIS. BARR: \$5
2	1078	1086	1094	1104	1120	1135	1151	1167	1183	
3	1104	1112	1120	1130	1146	1161	1177	1193	1209	
4	1130	1138	1146	1156	1172	1187	1203	1219	1235	

Cannot be used with motion chairs.

### Accessories

#### URETHANE ARM CAPS

\$218 2 Arms Available in black, sable or dove.

#### Specify:

- Product Number
- Wood Finish
- Urethane Finish
- Fabric Vendor, Pattern and Color

See pages 16 & 17 for material and finish options.

# Laurelwood Bariatric



## 7324057 BARIATRIC CHAIR, 20" SEAT, WOOD ARM

W: 24" D: 25.5" H: 35" SW: 20" SD: 18.75" SH: 18" AH: 25.75" WT: 27 lb COM: 1.5 yd WT CAP: 750 lb

ZONE	B/COM	C	D	E	F	G	H	I	J	GENERAL INFORMATION
1	1662	1692	1721	1757	1817	1875	1935	1994	2054	MATERIAL: Beech MOIS. BARR: \$18
2	1703	1733	1762	1798	1858	1916	1976	2035	2095	
3	1744	1774	1803	1839	1899	1957	2017	2076	2136	
4	1785	1815	1844	1880	1940	1998	2058	2117	2177	

## 7324051 BARIATRIC CHAIR, 25" SEAT, WOOD ARM

W: 29" D: 24.75" H: 35" SW: 25" SD: 18.75" SH: 18" AH: 25.75" WT: 34 lb COM: 2.3 yd WT CAP: 750 lb

ZONE	B/COM	C	D	E	F	G	H	I	J	GENERAL INFORMATION
1	2335	2381	2425	2480	2572	2661	2753	2843	2935	MATERIAL: Beech MOIS. BARR: \$28
2	2392	2438	2482	2537	2629	2718	2810	2900	2992	
3	2450	2496	2540	2595	2687	2776	2868	2958	3050	
4	2507	2553	2597	2652	2744	2833	2925	3015	3107	



## 7324052 BARIATRIC CHAIR, 30" SEAT, WOOD ARM

W: 34" D: 24.75" H: 35" SW: 30" SD: 18.75" SH: 18" AH: 25.75" WT: 38 lb COM: 2.3 yd WT CAP: 750 lb

ZONE	B/COM	C	D	E	F	G	H	I	J	GENERAL INFORMATION
1	2496	2542	2586	2641	2733	2822	2914	3004	3096	MATERIAL: Beech MOIS. BARR: \$28
2	2557	2603	2647	2702	2794	2883	2975	3065	3157	
3	2619	2665	2709	2764	2856	2945	3037	3127	3219	
4	2680	2726	2770	2825	2917	3006	3098	3188	3280	

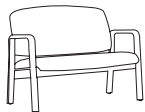

## 7324053 BARIATRIC LOVESEAT, 40" SEAT, WOOD ARM

W: 44" D: 24.75" H: 35" SW: 40" SD: 18.75" SH: 18" AH: 25.75" WT: 44 lb COM: 2.7 yd WT CAP: 750 lb

ZONE	B/COM	C	D	E	F	G	H	I	J	GENERAL INFORMATION
1	2682	2736	2788	2852	2960	3066	3174	3279	3387	MATERIAL: Beech MOIS. BARR: \$32
2	2748	2802	2854	2918	3026	3132	3240	3345	3453	
3	2814	2868	2920	2984	3092	3198	3306	3411	3519	
4	2880	2934	2986	3050	3158	3264	3372	3477	3585	

### Accessories

#### URETHANE ARM CAPS

\$218 2 Arms Available in black, sable or dove.

#### Specify:

- Product Number
- Wood Finish
- Urethane Cap Color
- Fabric Vendor, Pattern and Color

See pages 16 & 17 for material and finish options.

# Laurelwood Bariatric Mid Back



## 7324060 BARIATRIC CHAIR, 25" SEAT, WOOD ARM, MID-BACK

W: 29" D: 24.75" H: 39" SW: 25" SD: 18.75" SH: 18" AH: 25.75" WT: 37 lb COM: 2.5 yd WT CAP: 750 lb

ZONE	B/COM	C	D	E	F	G	H	I	J	GENERAL INFORMATION
1	2449	2499	2547	2607	2707	2804	2904	3002	3102	MATERIAL: Beech MOIS. BARR: \$30
2	2509	2559	2607	2667	2767	2864	2964	3062	3162	
3	2569	2619	2667	2727	2827	2924	3024	3122	3222	
4	2630	2680	2728	2788	2888	2985	3085	3183	3283	



## 7324061 BARIATRIC CHAIR, 30" SEAT, WOOD ARM, MID-BACK

W: 34" D: 24.75" H: 39" SW: 30" SD: 18.75" SH: 18" AH: 25.75" WT: 43 lb COM: 2.5 yd WT CAP: 750 lb

ZONE	B/COM	C	D	E	F	G	H	I	J	GENERAL INFORMATION
1	2607	2657	2705	2765	2865	2962	3062	3160	3260	MATERIAL: Beech MOIS. BARR: \$30
2	2671	2721	2769	2829	2929	3026	3126	3224	3324	
3	2735	2785	2833	2893	2993	3090	3190	3288	3388	
4	2800	2850	2898	2958	3058	3155	3255	3353	3453	

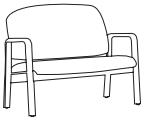

## 7324062 BARIATRIC LOVESEAT, 40" SEAT, WOOD ARM, MID-BACK

W: 44" D: 24.75" H: 39" SW: 40" SD: 18.75" SH: 18" AH: 25.75" WT: 49 lb COM: 2.7 yd WT CAP: 750 lb

ZONE	B/COM	C	D	E	F	G	H	I	J	GENERAL INFORMATION
1	2794	2848	2900	2964	3072	3178	3286	3391	3499	MATERIAL: Beech MOIS. BARR: \$32
2	2863	2917	2969	3033	3141	3247	3355	3460	3568	
3	2932	2986	3038	3102	3210	3316	3424	3529	3637	
4	3000	3054	3106	3170	3278	3384	3492	3597	3705	

### Accessories



#### 7144001 REAR LOCKING CASTERS, FRONT NON-LOCKING, CARPET SURFACE (SET OF FOUR)

STEM SIZE: 50 mm CASTER SIZE: 2"  
LOAD CAP: 110 lb p/caster WT: 1 lb

\$147

*Includes two front non-locking casters and two rear locking casters.*



#### 7144004 CASTERS, HARD SURFACE (SET OF TWO)

STEM SIZE: 50 mm CASTER SIZE: 2"  
LOAD CAP: 110 lb p/caster WT: 0.5 lb

\$117

*Specify locking or non-locking for front or rear legs when ordering.*



#### 7144002 CASTERS, CARPET SURFACE (SET OF TWO)

STEM SIZE: 50 mm CASTER SIZE: 2"  
LOAD CAP: 110 lb p/caster WT: 0.5 lb

\$117

*Specify locking or non-locking for front or rear legs when ordering.*



#### 7144100 TIP BACK CASTERS (SET OF TWO)

\$134 per chair WT: 0.5 lb

#### URETHANE ARM CAPS

\$218 2 Arms

*Available in black, sable or dove.*



#### 7144003 REAR LOCKING CASTERS, FRONT NON-LOCKING, HARD SURFACE (SET OF FOUR)

STEM SIZE: 50 mm CASTER SIZE: 2"  
LOAD CAP: 110 lb p/caster WT: 1 lb

\$147

*Includes two front non-locking casters and two rear locking casters.*

#### Specify:

- Product Number
- Wood Finish
- Urethane Cap Color
- Fabric Vendor, Pattern and Color

See pages 16 & 17 for material and finish options.



**7026600 SIDE CHAIR, UPH SEAT AND BACK**

W: 19"	D: 26"	H: 32"	SW: 19"	SD: 18.5"	SH: 18.5"	AH: -	WT: 17 lb	COM: 1.5 yd	WT CAP: 500 lb	
ZONE	B/COM	C	D	E	F	G	H	I	J	GENERAL INFORMATION
1	924	954	983	1019	1079	1137	1197	1256	1316	MATERIAL: Beech
2	946	976	1005	1041	1101	1159	1219	1278	1338	MOIS. BARR: Included
3	969	999	1028	1064	1124	1182	1242	1301	1361	
4	992	1022	1051	1087	1147	1205	1265	1324	1384	

Price includes Plastitack glides. Modular seating orders must include a layout to ensure proper configuration.

**7026601 SIDE CHAIR, WIDE, UPH SEAT AND BACK**

W: 27"	D: 26"	H: 32"	SW: 27"	SD: 18.5"	SH: 18.5"	AH: -	WT: 22 lb	COM: 2.25 yd	WT CAP: 750 lb	
ZONE	B/COM	C	D	E	F	G	H	I	J	GENERAL INFORMATION
1	1062	1107	1150	1204	1294	1382	1472	1559	1649	MATERIAL: Beech
2	1088	1133	1176	1230	1320	1408	1498	1585	1675	MOIS. BARR: Included
3	1113	1158	1201	1255	1345	1433	1523	1610	1700	
4	1139	1184	1227	1281	1371	1459	1549	1636	1726	

Price includes Plastitack glides. Modular seating orders must include a layout to ensure proper configuration.



**7326600 ARM CHAIR, UPH SEAT AND BACK**

W: 21.5"	D: 26"	H: 32"	SW: 19"	SD: 18.5"	SH: 18.5"	AH: 26.5"	WT: 18 lb	COM: 1.5 yd	WT CAP: 500 lb	
ZONE	B/COM	C	D	E	F	G	H	I	J	GENERAL INFORMATION
1	1071	1101	1130	1166	1226	1284	1344	1403	1463	MATERIAL: Beech
2	1097	1127	1156	1192	1252	1310	1370	1429	1489	MOIS. BARR: Included
3	1123	1153	1182	1218	1278	1336	1396	1455	1515	
4	1150	1180	1209	1245	1305	1363	1423	1482	1542	

Price includes Plastitack glides. Nylon arm caps are available in black, sable or dove. Modular seating orders must include a layout to ensure proper configuration. There is a deduct per chair if specified without arm caps. Call for details.

**7326601 ARM CHAIR, WIDE, UPH SEAT AND BACK**

W: 29.5"	D: 26"	H: 32"	SW: 27"	SD: 18.5"	SH: 18.5"	AH: 26.5"	WT: 22 lb	COM: 2.25 yd	WT CAP: 750 lb	
ZONE	B/COM	C	D	E	F	G	H	I	J	GENERAL INFORMATION
1	1214	1259	1302	1356	1446	1534	1624	1711	1801	MATERIAL: Beech
2	1243	1288	1331	1385	1475	1563	1653	1740	1830	MOIS. BARR: Included
3	1273	1318	1361	1415	1505	1593	1683	1770	1860	
4	1302	1347	1390	1444	1534	1622	1712	1799	1889	

Price includes Plastitack glides. Nylon arm caps are available in black, sable or dove. Modular seating orders must include a layout to ensure proper configuration. There is a deduct per chair if specified without arm caps. Call for details.

**Accessories**



**7076600 GANGING KIT**

\$47 per kit

Add one ganging kit for each chair or table. Arm and armless chairs and tables can be ganged.

**OPTIONAL NYLON ARM CAPS**

-\$24 DEDUCT

There is a deduct per chair if specified without arm caps.

**Specify:**

- Product Number
- Wood Finish
- Arm Cap Color
- Fabric Vendor, Pattern and Color

See pages 16 & 17 for material and finish options.



## 7016600 SPANNER TABLE, NARROW

W: 19"      D: 26"      H: 20"      WT: 18 lb

### GENERAL INFORMATION

MATERIAL: Beech  
MOIS. BARR: -

Zone	1	2	3	4
	1003	1028	1053	1078

Price includes Plastitack glides. Tops are available with thermoform, laminate with self-edge or laminate with vinyl edge. Specify black, white, brown, gray, or almond. Modular seating orders must include a layout to ensure proper configuration.

## 7016601 SPANNER TABLE, WIDE

W: 29.5"      D: 26"      H: 20"      WT: 26 lb

### GENERAL INFORMATION

MATERIAL: Beech  
MOIS. BARR: -

Zone	1	2	3	4
	1134	1162	1191	1219

Price includes Plastitack glides. Tops are available with thermoform, laminate with self-edge or laminate with vinyl edge. Specify black, white, brown, gray, or almond. Modular seating orders must include a layout to ensure proper configuration.

### Accessories



## 7076600 GANGING KIT

\$47 per kit

Add one ganging kit for each chair or table. Arm and armless chairs and tables can be ganged.

#### Specify:

- Product Number
- Thermoform Color
- Laminate Vendor, Pattern and Finish
- T-Mold Edge Color

See pages 16 & 17 for material and finish options.



## 68MN01M CHAIR, WOOD ARM

W: 25.25" D: 26.25" H: 33.75" SW: 21" SD: 18" SH: 18" AH: 25" WT: 22 lb COM: 1.75 yd WT CAP: 500 lb

ZONE	B/COM	C	D	E	F	G	H	I	J	GENERAL INFORMATION
1	1631	1666	1699	1741	1811	1880	1950	2018	2088	MATERIAL: Beech MOIS. BARR: \$21
2	1671	1706	1739	1781	1851	1920	1990	2058	2128	
3	1711	1746	1779	1821	1891	1960	2030	2098	2168	
4	1751	1786	1819	1861	1931	2000	2070	2138	2208	

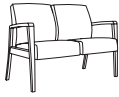

## 68MN02M LOVESEAT, WOOD ARM

W: 44.75" D: 26.25" H: 33.75" SW: 21" SD: 18" SH: 18" AH: 25" WT: 49 lb COM: 3.5 yd WT CAP: 750 lb

ZONE	B/COM	C	D	E	F	G	H	I	J	GENERAL INFORMATION
1	2615	2685	2752	2836	2976	3112	3252	3389	3529	MATERIAL: Beech MOIS. BARR: \$42
2	2679	2749	2816	2900	3040	3176	3316	3453	3593	
3	2743	2813	2880	2964	3104	3240	3380	3517	3657	
4	2807	2877	2944	3028	3168	3304	3444	3581	3721	



## 68MN03M SOFA, WOOD ARM

W: 67.5" D: 26.25" H: 33.75" SW: 21" SD: 18" SH: 18" AH: 25" WT: 73 lb COM: 5.25 yd WT CAP: 1000 lb

ZONE	B/COM	C	D	E	F	G	H	I	J	GENERAL INFORMATION
1	3643	3748	3848	3974	4184	4389	4599	4803	5013	MATERIAL: Beech MOIS. BARR: \$63
2	3732	3837	3937	4063	4273	4478	4688	4892	5102	
3	3821	3926	4026	4152	4362	4567	4777	4981	5191	
4	3910	4015	4115	4241	4451	4656	4866	5070	5280	



## 68MN12M LOVESEAT, WOOD ARM, SHORT CENTER ARMS

W: 48" D: 26.25" H: 33.75" SW: 21" SD: 18" SH: 18" AH: 25" WT: 49 lb COM: 3.5 yd WT CAP: 750 lb

ZONE	B/COM	C	D	E	F	G	H	I	J	GENERAL INFORMATION
1	2903	2973	3040	3124	3264	3400	3540	3677	3817	MATERIAL: Beech MOIS. BARR: \$42
2	2974	3044	3111	3195	3335	3471	3611	3748	3888	
3	3045	3115	3182	3266	3406	3542	3682	3819	3959	
4	3117	3187	3254	3338	3478	3614	3754	3891	4031	

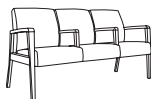

## 68MN13M SOFA, WOOD ARM, SHORT CENTER ARMS

W: 70.5" D: 26.25" H: 33.75" SW: 21" SD: 18" SH: 18" AH: 25" WT: 73 lb COM: 5.25 yd WT CAP: 1000 lb

ZONE	B/COM	C	D	E	F	G	H	I	J	GENERAL INFORMATION
1	4265	4370	4470	4596	4806	5011	5221	5425	5635	MATERIAL: Beech MOIS. BARR: \$63
2	4370	4475	4575	4701	4911	5116	5326	5530	5740	
3	4474	4579	4679	4805	5015	5220	5430	5634	5844	
4	4579	4684	4784	4910	5120	5325	5535	5739	5949	



## 68MN01L LOVESEAT, WOOD ARM, CONTINUOUS SEAT

W: 46.25" D: 26.25" H: 33.75" SW: 42" SD: 18" SH: 18" AH: 25" WT: 49 lb COM: 4 yd WT CAP: 750 lb

ZONE	B/COM	C	D	E	F	G	H	I	J	GENERAL INFORMATION
1	2635	2715	2791	2887	3047	3203	3363	3519	3679	MATERIAL: Beech MOIS. BARR: \$48
2	2699	2779	2855	2951	3111	3267	3427	3583	3743	
3	2764	2844	2920	3016	3176	3332	3492	3648	3808	
4	2828	2908	2984	3080	3240	3396	3556	3712	3872	

Specify:

- Product Number
- Wood Finish
- Fabric Vendor, Pattern and Color

See pages 16 & 17 for material and finish options.



## 68MN22M 2 SEAT TANDEM, WOOD ARM

W: 48" D: 26.25" H: 33.75" SW: 21" SD: 18" SH: 18" AH: 25" WT: 49 lb COM: 3.5 yd WT CAP: 750 lb

ZONE	B/COM	C	D	E	F	G	H	I	J	GENERAL INFORMATION
1	2903	2973	3040	3124	3264	3400	3540	3677	3817	MATERIAL: Beech MOIS. BARR: \$42
2	2974	3044	3111	3195	3335	3471	3611	3748	3888	
3	3045	3115	3182	3266	3406	3542	3682	3819	3959	
4	3117	3187	3254	3338	3478	3614	3754	3891	4031	



## 68MN23M 3 SEAT TANDEM, WOOD ARM

W: 70.5" D: 26.25" H: 33.75" SW: 21" SD: 18" SH: 18" AH: 25" WT: 73 lb COM: 5.25 yd WT CAP: 500 lb

ZONE	B/COM	C	D	E	F	G	H	I	J	GENERAL INFORMATION
1	4265	4370	4470	4596	4806	5011	5221	5425	5635	MATERIAL: Beech MOIS. BARR: \$63
2	4370	4475	4575	4701	4911	5116	5326	5530	5740	
3	4474	4579	4679	4805	5015	5220	5430	5634	5844	
4	4579	4684	4784	4910	5120	5325	5535	5739	5949	



## 68MN01G CHAIR, WIDE, WOOD ARM, BARIATRIC

W: 34.25" D: 26.25" H: 33.75" SW: 30" SD: 18" SH: 18" AH: 25" WT: 32 lb COM: 3 yd WT CAP: 750 lb

ZONE	B/COM	C	D	E	F	G	H	I	J	GENERAL INFORMATION
1	2231	2291	2348	2420	2540	2657	2777	2894	3014	MATERIAL: Beech MOIS. BARR: \$36
2	2286	2346	2403	2475	2595	2712	2832	2949	3069	
3	2340	2400	2457	2529	2649	2766	2886	3003	3123	
4	2395	2455	2512	2584	2704	2821	2941	3058	3178	

### Accessories

#### URETHANE ARM CAPS

\$153	2 Arms
\$230	3 Arms
\$306	4 Arms

Available in black only.

#### Specify:

- Product Number
- Wood Finish
- Fabric Vendor, Pattern and Color

See pages 16 & 17 for material and finish options.



## 68MN01H PATIENT CHAIR, WOOD ARM, HIGH BACK

W: 25.25" D: 26.25" H: 47.5" SW: 21" SD: 18" SH: 18" AH: 25" WT: 33 lb COM: 2.5 yd WT CAP: 500 lb

ZONE	B/COM	C	D	E	F	G	H	I	J	GENERAL INFORMATION
1	1972	2022	2070	2130	2230	2327	2427	2525	2625	MATERIAL: Beech MOIS. BARR: \$30
2	2020	2070	2118	2178	2278	2375	2475	2573	2673	
3	2069	2119	2167	2227	2327	2424	2524	2622	2722	
4	2117	2167	2215	2275	2375	2472	2572	2670	2770	

## 68MN30F OTTOMAN, WOOD

W: 19.25 D: 12.25 H: 11.5 SW: - SD: - SH: - AH: - WT: 16 COM: .5 yd WT CAP: -

ZONE	B/COM	C	D	E	F	G	H	I	J	GENERAL INFORMATION
1	1017	1027	1037	1049	1069	1088	1108	1128	1148	MATERIAL: Beech MOIS. BARR: \$6
2	1042	1052	1062	1074	1094	1113	1133	1153	1173	
3	1067	1077	1087	1099	1119	1138	1158	1178	1198	
4	1093	1103	1113	1125	1145	1164	1184	1204	1224	



## 68MN01MR FLEX BACK CHAIR, WOOD ARM

W: 25.25" D: 27.5" H: 33.75" SW: 21" SD: 18" SH: 18" AH: 25" WT: 30 lb COM: 1.75 yd WT CAP: 500 lb

ZONE	B/COM	C	D	E	F	G	H	I	J	GENERAL INFORMATION
1	2430	2465	2498	2540	2610	2679	2749	2817	2887	MATERIAL: Beech MOIS. BARR: \$21
2	2490	2525	2558	2600	2670	2739	2809	2877	2947	
3	2550	2585	2618	2660	2730	2799	2869	2937	3007	
4	2610	2645	2678	2720	2790	2859	2929	2997	3067	



## 68MN01HR FLEX BACK CHAIR, WOOD ARM, HIGH BACK

W: 25.25" D: 27.5" H: 47.5" SW: 21" SD: 18" SH: 18" AH: 25" WT: 35 lb COM: 2.5 yd WT CAP: 500 lb

ZONE	B/COM	C	D	E	F	G	H	I	J	GENERAL INFORMATION
1	3030	3080	3128	3188	3288	3385	3485	3583	3683	MATERIAL: Beech MOIS. BARR: \$30
2	3105	3155	3203	3263	3363	3460	3560	3658	3758	
3	3180	3230	3278	3338	3438	3535	3635	3733	3833	
4	3254	3304	3352	3412	3512	3609	3709	3807	3907	

### Accessories

#### URETHANE ARM CAPS

\$153 2 Arms

Available in black only.

#### Specify:

- Product Number
- Wood Finish
- Fabric Vendor, Pattern and Color

See pages 16 & 17 for material and finish options.

# Monroe Freestanding Tables



## 68MN2424SQ FREESTANDING END TABLE, 24"

W: 24"      D: 24"      H: 18"      WT: 47 lb

### GENERAL INFORMATION

MATERIAL: Beech  
MOIS. BARR: -

Zone	1	2	3	4
	1450	1486	1522	1559

Laminate top with wood base, see edge styles below.

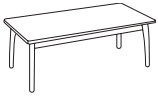

## 68MN2448RE FREESTANDING COFFEE TABLE, RECTANGULAR

W: 48"      D: 24"      H: 18"      WT: 64 lb

### GENERAL INFORMATION

MATERIAL: Beech  
MOIS. BARR: -

Zone	1	2	3	4
	1711	1754	1797	1839

Laminate top with wood base, see edge styles below.



## 68MN3030SQ FREESTANDING END TABLE, 30"

W: 30"      D: 30"      H: 18"      WT: 57 lb

### GENERAL INFORMATION

MATERIAL: Beech  
MOIS. BARR: -

Zone	1	2	3	4
	1624	1665	1705	1746

Laminate top with wood base, see edge styles below.



## 68MN22DIA FREESTANDING END TABLE, ROUND

W: 22"      D: 22"      H: 18"      WT: 47 lb

### GENERAL INFORMATION

MATERIAL: Beech  
MOIS. BARR: -

Zone	1	2	3	4
	1697	1739	1782	1824

Laminate top with wood base, see edge styles below.

### Edge Style Options



#### FLAT PVC EDGE

Available in 7 colors to match metal finishes.



#### SELF EDGE

Matches top laminate.



#### 2MM BIO EDGE

Available in 7 colors to match metal finishes.



#### 2MM PVC WOOD GRAIN EDGE

Available in 9 wood grain colors to match standard laminates.

#### Specify:

- Product Number
- Wood Finish
- Laminate Vendor, Pattern and Finish
- Edge Profile

See pages 16 & 17 for material and finish options.

# Monroe Modular Tables



## 68MNR2828 CORNER TABLE, RADIUS, MODULAR

### GENERAL INFORMATION

W: 28"      D: 28"      H: 18"      WT: 42 lb

MATERIAL: Laminate  
MOIS. BARR: -

Zone	1	2	3	4
	1340	1374	1407	1440

Modular table orders must include a layout to ensure proper configuration.



## 68MN2828 CORNER TABLE, SQUARE, MODULAR

### GENERAL INFORMATION

W: 28"      D: 28"      H: 18"      WT: 46 lb

MATERIAL: Laminate  
MOIS. BARR: -

Zone	1	2	3	4
	1464	1501	1537	1574

Modular table orders must include a layout to ensure proper configuration.



## 68MNT45DEG CORNER TABLE, ANGLED, MODULAR

### GENERAL INFORMATION

W: -      D: -      H: 18"      WT: 40 lb

MATERIAL: Laminate  
MOIS. BARR: -

Zone	1	2	3	4
	1340	1374	1407	1440

Modular table orders must include a layout to ensure proper configuration.



## 68MN2421 SPANNER TABLE, MODULAR

### GENERAL INFORMATION

W: 24"      D: 21"      H: 18"      WT: 27 lb

MATERIAL: Laminate  
MOIS. BARR: -

Zone	1	2	3	4
	908	931	953	976

Modular table orders must include a layout to ensure proper configuration.



## 68MNET2124 END TABLE, MODULAR

### GENERAL INFORMATION

W: 24"      D: 21"      H: 18"      WT: 37 lb

MATERIAL: Laminate  
MOIS. BARR: -

Zone	1	2	3	4
	1214	1244	1275	1305

Modular table orders must include a layout to ensure proper configuration.

### Edge Style Options

Specify:

- Product Number
- Laminate Vendor, Pattern and Finish
- Edge Profile

See pages 16 & 17 for material and finish options.



#### FLAT PVC EDGE

Available in 7 colors to match metal finishes.



#### SELF EDGE

Matches top laminate.



#### 2MM BIO EDGE

Available in 7 colors to match metal finishes.



#### 2MM PVC WOOD GRAIN EDGE

Available in 9 wood grain colors to match standard laminates.



## 7029201 RESIN FOLDING CHAIR, UPH SEAT AND BACK, STACKING

W: 20" D: 22.75" H: 32.5" SW: 17.25" SD: 18" SH: 18" AH: - WT: 15 COM: .5 yd WT CAP: 400 lb

ZONE	B/COM	C	D	E	F	G	H	I	J	GENERAL INFORMATION
1	964	974	984	996	1016	1035	1055	1075	1095	MATERIAL: Resin MOIS. BARR: \$6
2	988	998	1008	1020	1040	1059	1079	1099	1119	
3	1012	1022	1032	1044	1064	1083	1103	1123	1143	
4	1036	1046	1056	1068	1088	1107	1127	1147	1167	

Available in one color only, oyster. Deduct \$60 when standard poly under seat panel is not included. COM yardage is 0.7 yards if quantity is 5 or less.

### Accessories



#### 7034126 DOLLY FOR FOLDING CHAIRS

W: 21"	D: 49"	H: 53"	WT: 63 lb
Zone 1	Zone 2	Zone 3	Zone 4
\$1543	\$1582	\$1620	\$1659

Dolly extension (7034003) is available. Chairs stack 16 high with the dolly and 20 high with the dolly extension.

#### 7034003 DOLLY EXTENSION

W: 21"	D: 49"	H: 65"	WT: 63 lb
\$315			

#### 7170003 SMARTRAIL®

W: 23.5"	D: 3"	H: 5"	WT: 3 lb
\$225			



No additional hardware is needed. SmartRail® requires no additional hardware to hang the chair. All wall fasteners are included with the SmartRail®.

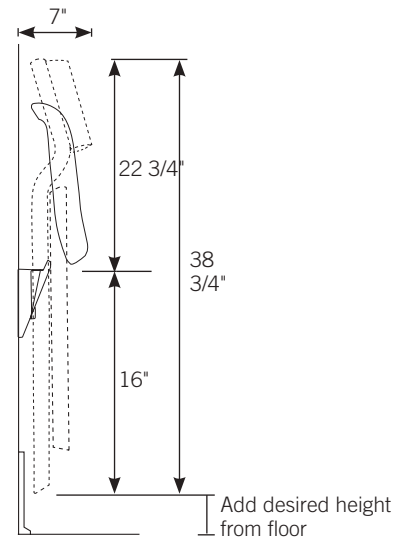

#### Specify:

- Product Number
- Fabric Vendor, Pattern and Color

See pages 16 & 17 for material and finish options.



## 7028201 FOLDING CHAIR, UPH SEAT AND BACK, WOOD BACKSIDE, STACKING

W: 19" D: 22.75" H: 32.5" SW: 16.25" SD: 18" SH: 18" AH: - WT: 15 lb COM: .5 yd WT CAP: 400 lb

ZONE	B/COM	C	D	E	F	G	H	I	J	GENERAL INFORMATION
1	829	839	849	861	881	900	920	940	960	MATERIAL: Beech MOIS. BARR: \$6
2	850	860	870	882	902	921	941	961	981	
3	870	880	890	902	922	941	961	981	1001	
4	891	901	911	923	943	962	982	1002	1022	

Price includes Plastitack glides. Back edge wall guard is standard. COM yardage is 0.7 yards if quantity is 5 or less.



## 7028202 FOLDING CHAIR, UPH SEAT AND BACK, WOOD BACKSIDE, 2" WIDER, STACKING

W: 21" D: 22.75" H: 32.5" SW: 18.25" SD: 18" SH: 18" AH: - WT: 15 lb COM: .5 yd WT CAP: 400 lb

ZONE	B/COM	C	D	E	F	G	H	I	J	GENERAL INFORMATION
1	854	864	874	886	906	925	945	965	985	MATERIAL: Beech MOIS. BARR: \$6
2	875	885	895	907	927	946	966	986	1006	
3	896	906	916	928	948	967	987	1007	1027	
4	917	927	937	949	969	988	1008	1028	1048	

Price includes Plastitack glides. Back edge wall guard is standard. COM yardage is 0.7 yards if quantity is 5 or less.



## 7028204 FOLDING CHAIR, UPH SEAT, WOOD BACK, STACKING

W: 19" D: 22.75" H: 32.5" SW: 16.25" SD: 18" SH: 18" AH: - WT: 15 lb COM: .4 yd WT CAP: 400 lb

ZONE	B/COM	C	D	E	F	G	H	I	J	GENERAL INFORMATION
1	903	911	919	929	945	960	976	992	1008	MATERIAL: Beech MOIS. BARR: \$5
2	925	933	941	951	967	982	998	1014	1030	
3	948	956	964	974	990	1005	1021	1037	1053	
4	970	978	986	996	1012	1027	1043	1059	1075	

Price includes Plastitack glides. Not available with back edge wall guard. COM yardage is 0.7 yards if quantity is 5 or less.



## 7023201 FOLDING CHAIR, WOOD SEAT, WOOD BACK, STACKING

W: 19" D: 22.75" H: 32.5" SW: 16.25" SD: 18" SH: 18" AH: - WT: 15 lb COM: - WT CAP: 400 lb

Zone	1	2	3	4	GENERAL INFORMATION
	971	995	1020	1044	MATERIAL: Beech MOIS. BARR: -

Price includes Plastitack glides. Not available with back edge wall guard.

**Specify:**

- Product Number
- Wood Finish
- Fabric Vendor, Pattern and Color

**See pages 16 & 17 for material and finish options.**

## Accessories



### 7100001 LASER CUT

\$210 per chair  
 \$320 set up charge per design  
 See Ordering Information for Laser Cut information.



### 7100002 LASER CUT WITH COLOR FILL

\$315 per chair  
 \$320 set up charge per design  
 See Ordering Information for Laser Cut information.

### CUSTOM CNC BACK ROUTE

\$158 per chair  
 \$873 set up charge per design  
 See Ordering Information.



### 7190004 UNDERSEAT PANEL, PLYFOLD STANDARD WIDTH

W: 18"    D: 19"    WT: 1 lb    Beech  
 \$99  
 Panels with vinyl or crypton upholstered seats will be drilled for ventilation. Not available for chairs with all-wood seats.



### 7190012 UNDERSEAT PANEL, PLYFOLD WIDER WIDTH

W: 18"    D: 19"    WT: 1 lb    Beech  
 \$105  
 Panels with vinyl or crypton upholstered seats will be drilled for ventilation. Not available for chairs with all-wood seats.

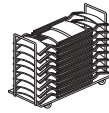

### 7034126 DOLLY FOR FOLDING CHAIRS

W: 21"	D: 49"	H: 53"	WT: 63 lb
Zone 1	Zone 2	Zone 3	Zone 4
\$1543	\$1582	\$1620	\$1659

Dolly extension (7034003) is available. Chairs stack 16 high with the dolly and 20 high with the dolly extension.



### 7034127 DOLLY FOR FOLDING CHAIRS, 2" WIDER

W: 23"	D: 49"	H: 53"	WT: 63 lb
Zone 1	Zone 2	Zone 3	Zone 4
\$1570	\$1609	\$1648	\$1688

Dolly extension (7034003) is available. Chairs stack 16 high with the dolly and 20 high with the dolly extension.

### 7034003 DOLLY EXTENSION

W: 21"	D: 49"	H: 65"	WT: 63 lb
\$315			

### 7170003 SMARTRAIL

W: 23.5"	D: 3"	H: 5"	WT: 3 lb
\$225			

No additional hardware is needed. SmartRail requires no additional hardware to hang the chair. All wall fasteners are included with the SmartRail.

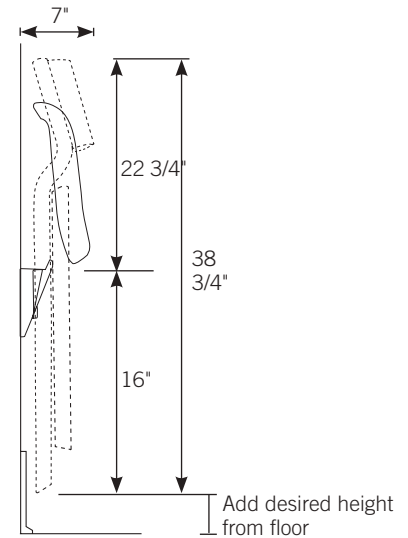

# PlyLok Upholstered Seat



## 7028742 SIDE CHAIR, UPH SEAT, STACKING

W: 20" D: 22.25" H: 32.75" SW: 16.75" SD: 17.5" SH: 18" AH: - WT: 18 lb COM: .8 yd WT CAP: 750 lb

ZONE	B/COM	C	D	E	F	G	H	I	J	GENERAL INFORMATION
1	649	665	680	699	731	762	794	826	858	MATERIAL: Beech MOIS. BARR: \$10 2" SEAT FOAM: \$29
2	665	681	696	715	747	778	810	842	874	
3	681	697	712	731	763	794	826	858	890	
4	697	713	728	747	779	810	842	874	906	

Price includes Chrome Rubber cushioned glides. Plylok chairs without arms stack 8 high. Multiple back style options are available at no additional charge, refer to Back Styles section for more details when ordering.



## 7028744 SIDE CHAIR, UPH SEAT, 2" NARROWER, STACKING

W: 18" D: 22" H: 32.25" SW: 16.75" SD: 17.5" SH: 18" AH: - WT: 18 lb COM: .8 yd WT CAP: 750 lb

ZONE	B/COM	C	D	E	F	G	H	I	J	GENERAL INFORMATION
1	649	665	680	699	731	762	794	826	858	MATERIAL: Beech MOIS. BARR: \$10 2" SEAT FOAM: \$29
2	665	681	696	715	747	778	810	842	874	
3	681	697	712	731	763	794	826	858	890	
4	697	713	728	747	779	810	842	874	906	

Price includes Chrome Rubber cushioned glides. Plylok chairs without arms stack 8 high. Multiple back style options are available at no additional charge, refer to Back Styles section for more details when ordering.



## 7028749 SIDE CHAIR, UPH SEAT, 2" WIDER, STACKING

W: 22.25" D: 23" H: 33.75" SW: 18.75" SD: 17.5" SH: 18" AH: - WT: 20 lb COM: .9 yd WT CAP: 750 lb

ZONE	B/COM	C	D	E	F	G	H	I	J	GENERAL INFORMATION
1	704	722	740	761	797	832	868	903	939	MATERIAL: Beech MOIS. BARR: \$11 2" SEAT FOAM: \$29
2	721	739	757	778	814	849	885	920	956	
3	738	756	774	795	831	866	902	937	973	
4	756	774	792	813	849	884	920	955	991	

Price includes Chrome Rubber cushioned glides. Plylok chairs without arms stack 8 high. Multiple back style options are available at no additional charge, refer to Back Styles section for more details when ordering.



## 7328748 ARM CHAIR, UPH SEAT, STACKING

W: 24" D: 22.25" H: 32.75" SW: 16.75" SD: 17.5" SH: 18" AH: 25" WT: 22 lb COM: .8 yd WT CAP: 750 lb

ZONE	B/COM	C	D	E	F	G	H	I	J	GENERAL INFORMATION
1	870	886	901	920	952	983	1015	1047	1079	MATERIAL: Beech MOIS. BARR: \$11 2" SEAT FOAM: \$29
2	891	907	922	941	973	1004	1036	1068	1100	
3	913	929	944	963	995	1026	1058	1090	1122	
4	934	950	965	984	1016	1047	1079	1111	1143	

Price includes Chrome Rubber cushioned glides. Plylok arm chairs stack 7 high. Multiple back style options are available at no additional charge, refer to Back Styles section for more details when ordering.



## 7328749 ARM CHAIR, UPH SEAT, 2" WIDER, STACKING

W: 26.25" D: 23" H: 33.75" SW: 18.75" SD: 17.5" SH: 18" AH: - WT: 24 lb COM: .9 yd WT CAP: 750 lb

ZONE	B/COM	C	D	E	F	G	H	I	J	GENERAL INFORMATION
1	923	941	959	980	1016	1051	1087	1122	1158	MATERIAL: Beech MOIS. BARR: \$11 2" SEAT FOAM: \$29
2	946	964	982	1003	1039	1074	1110	1145	1181	
3	968	986	1004	1025	1061	1096	1132	1167	1203	
4	991	1009	1027	1048	1084	1119	1155	1190	1226	

Price includes Chrome Rubber cushioned glides. Plylok arm chairs stack 7 high. Multiple back style options are available at no additional charge, refer to Back Styles section for more details when ordering.



## 7028843 SLEDBASE CHAIR, UPH SEAT, NON-STACKING

W: 20" D: 22.25" H: 32.5" SW: 16.75" SD: 17.5" SH: 18" AH: - WT: 23 lb COM: .8 yd WT CAP: 750 lb

ZONE	B/COM	C	D	E	F	G	H	I	J	GENERAL INFORMATION
1	771	787	802	821	853	884	916	948	980	MATERIAL: Beech MOIS. BARR: \$10 2" SEAT FOAM: \$29
2	790	806	821	840	872	903	935	967	999	
3	809	825	840	859	891	922	954	986	1018	
4	828	844	859	878	910	941	973	1005	1037	

Multiple back style options are available at no additional charge, refer to Back Styles section for more details when ordering.

Specify:

- Product Number
- Wood Finish
- Back Style
- Fabric Vendor, Pattern and Color

See pages 16 & 17 for material and finish options.

# PlyLok Wood Seat



## 7023711 SIDE CHAIR, WOOD SEAT, STACKING

W: 20" D: 22.25" H: 33.75" SW: 16.75" SD: 17.25" SH: 18" AH: - WT: 19 lb COM: .5 yd WT CAP: 750 lb

ZONE	B/COM	C	D	E	F	G	H	I	J	GENERAL INFORMATION
1	642	652	662	674	694	713	733	753	773	MATERIAL: Beech
2	658	668	678	690	710	729	749	769	789	MOIS. BARR: -
3	674	684	694	706	726	745	765	785	805	
4	690	700	710	722	742	761	781	801	821	

Price includes Chrome Rubber cushioned glides. Plylok chairs without arms stack 8 high. Multiple back style options are available at no additional charge, refer to Back Styles section for more details when ordering.



## 7023712 SIDE CHAIR, WOOD SEAT, 2" NARROWER, STACKING

W: 18" D: 22" H: 33.25" SW: 14.75" SD: 17.25" SH: 18" AH: - WT: 18 lb COM: .5 yd WT CAP: 750 lb

ZONE	B/COM	C	D	E	F	G	H	I	J	GENERAL INFORMATION
1	642	652	662	674	694	713	733	753	773	MATERIAL: Beech
2	658	668	678	690	710	729	749	769	789	MOIS. BARR: -
3	674	684	694	706	726	745	765	785	805	
4	690	700	710	722	742	761	781	801	821	

Price includes Chrome Rubber cushioned glides. Plylok chairs without arms stack 8 high. Multiple back style options are available at no additional charge, refer to Back Styles section for more details when ordering.



## 7023715 SLEDBASE CHAIR, WOOD SEAT, NON-STACKING

W: 20" D: 22.25" H: 33.5" SW: 16.75" SD: 17.25" SH: 18" AH: - WT: 24 lb COM: .5 yd WT CAP: 750 lb

ZONE	B/COM	C	D	E	F	G	H	I	J	GENERAL INFORMATION
1	766	776	786	798	818	837	857	877	897	MATERIAL: Beech
2	785	795	805	817	837	856	876	896	916	MOIS. BARR: -
3	804	814	824	836	856	875	895	915	935	
4	823	833	843	855	875	894	914	934	954	

Multiple back style options are available at no additional charge, refer to Back Styles section for more details when ordering. Nonstacking.



## 7323718 ARM CHAIR, WOOD SEAT, STACKING

W: 24" D: 22.25" H: 33.75" SW: 16.75" SD: 17.25" SH: 18" AH: 25" WT: 23 lb COM: .5 yd WT CAP: 750 lb

ZONE	B/COM	C	D	E	F	G	H	I	J	GENERAL INFORMATION
1	863	873	883	895	915	934	954	974	994	MATERIAL: Beech
2	884	894	904	916	936	955	975	995	1015	MOIS. BARR: -
3	906	916	926	938	958	977	997	1017	1037	
4	927	937	947	959	979	998	1018	1038	1058	

Price includes Chrome Rubber cushioned glides. Plylok arm chairs stack 7 high. Multiple back style options are available at no additional charge, refer to Back Styles section for more details when ordering.



## 7323719 ARM CHAIR, WOOD SEAT, 2" WIDER, STACKING

W: 26.25" D: 23" H: 33.75" SW: 18.75" SD: 17.25" SH: 18" AH: 25" WT: 25 lb COM: .5 yd WT CAP: 750 lb

ZONE	B/COM	C	D	E	F	G	H	I	J	GENERAL INFORMATION
1	899	909	919	931	951	970	990	1010	1030	MATERIAL: Beech
2	921	931	941	953	973	992	1012	1032	1052	MOIS. BARR: -
3	944	954	964	976	996	1015	1035	1055	1075	
4	966	976	986	998	1018	1037	1057	1077	1097	

Price includes Chrome Rubber cushioned glides. Plylok arm chairs stack 7 high. Multiple back style options are available at no additional charge, refer to Back Styles section for more details when ordering.

**Specify:**

- Product Number
- Wood Finish
- Back Style
- Fabric Vendor, Pattern and Color

See pages 16 & 17 for material and finish options.

# PlyLok Bar Stools, Counter Stools



## 7128744 BAR STOOL, UPH SEAT

W: 17.5" D: 23" H: 43.25" SW: 16.75" SD: 17.5" SH: 29" AH: - WT: 21 lb COM: .8 yd WT CAP: 750 lb

ZONE	B/COM	C	D	E	F	G	H	I	J	GENERAL INFORMATION
1	1202	1218	1233	1252	1284	1315	1347	1379	1411	MATERIAL: Beech MOIS. BARR: \$10 2" SEAT FOAM: \$29
2	1232	1248	1263	1282	1314	1345	1377	1409	1441	
3	1261	1277	1292	1311	1343	1374	1406	1438	1470	
4	1291	1307	1322	1341	1373	1404	1436	1468	1500	

Price includes Chrome Rubber cushioned glides. Multiple back style options are available at no additional charge, refer to Back Styles section for more details when ordering.

## 7123712 BAR STOOL, WOOD SEAT

W: 17.5" D: 23" H: 43.25" SW: 16.75" SD: 17.25" SH: 28" AH: - WT: 23 lb COM: .5 yd WT CAP: 750 lb

ZONE	B/COM	C	D	E	F	G	H	I	J	GENERAL INFORMATION
1	1192	1202	1212	1224	1244	1263	1283	1303	1323	MATERIAL: Beech MOIS. BARR: -
2	1222	1232	1242	1254	1274	1293	1313	1333	1353	
3	1251	1261	1271	1283	1303	1322	1342	1362	1382	
4	1281	1291	1301	1313	1333	1352	1372	1392	1412	

Price includes Chrome Rubber cushioned glides. Multiple back style options are available at no additional charge, refer to Back Styles section for more details when ordering.



## 7228744 COUNTER STOOL, UPH SEAT

W: 17.5" D: 23" H: 38.25" SW: 16.75" SD: 17.5" SH: 24" AH: - WT: 20 lb COM: .8 yd WT CAP: 750 lb

ZONE	B/COM	C	D	E	F	G	H	I	J	GENERAL INFORMATION
1	1194	1210	1225	1244	1276	1307	1339	1371	1403	MATERIAL: Beech MOIS. BARR: \$10 2" SEAT FOAM: \$29
2	1224	1240	1255	1274	1306	1337	1369	1401	1433	
3	1253	1269	1284	1303	1335	1366	1398	1430	1462	
4	1283	1299	1314	1333	1365	1396	1428	1460	1492	

Price includes Chrome Rubber cushioned glides. Multiple back style options are available at no additional charge, refer to Back Styles section for more details when ordering.

## 7223712 COUNTER STOOL, WOOD SEAT

W: 17.5" D: 23" H: 38.25" SW: 16.75" SD: 17.25" SH: 23" AH: - WT: 22 lb COM: .5 yd WT CAP: 750 lb

ZONE	B/COM	C	D	E	F	G	H	I	J	GENERAL INFORMATION
1	1186	1196	1206	1218	1238	1257	1277	1297	1317	MATERIAL: Beech MOIS. BARR: -
2	1215	1225	1235	1247	1267	1286	1306	1326	1346	
3	1245	1255	1265	1277	1297	1316	1336	1356	1376	
4	1274	1284	1294	1306	1326	1345	1365	1385	1405	

Price includes Chrome Rubber cushioned glides. Multiple back style options are available at no additional charge, refer to Back Styles section for more details when ordering.

Specify:

- Product Number
- Wood Finish
- Back Style
- Fabric Vendor, Pattern and Color

See pages 16 & 17 for material and finish options.

# PlyLok Back Styles and Accessories

## Back Styles

### UPH FRONT AND BACK



UFUBS  
SQUARE



UFUBR  
ROUND

### UPH FRONT AND WOOD BACK



UFWBS  
SQUARE\*\*

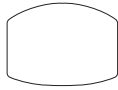

UFWBR  
ROUND\*\*

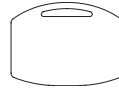

UFWBRH ROUND  
W/HANDHOLD\*\*

### WOOD FRONT AND BACK



AWBS  
SQUARE\*

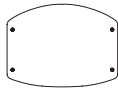

AWBR  
ROUND\*

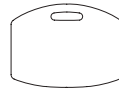

AWBRH ROUND  
W/HANDHOLD\*

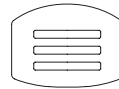

AWBL  
LADDER

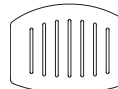

AWBM  
MISSION

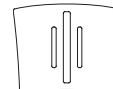

AWB3S  
3-SLOT

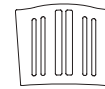

AWB6S  
6-SLOT

\*Custom CNC back rout and/or laser cut available.  
\*\* Laser cut available.

## Accessories



### 7100001 LASER CUT

\$210 per chair  
\$320 set up charge per design  
See Ordering Information for Laser Cut information.



### 7100002 LASER CUT WITH COLOR FILL

\$315 per chair  
\$320 set up charge per design  
See Ordering Information for Laser Cut information.

### CUSTOM CNC BACK ROUTE

\$158 per chair  
\$873 set up charge per design  
See Ordering Information.



### 7032000 UNIVERSAL 2-WHEEL CART

WT: 37 lb

Zone 1	Zone 2	Zone 3	Zone 4
\$1188	\$1218	\$1247	\$1277

Cart holds 8 side chairs and 7 arm chairs.



### 7144014 T MOLD RUNNER (SET OF TWO)

\$43 WT: 0.5 lb  
Available for 2- and 3-position and sledbase chairs.

### EXTENDED SEAT PAD

\$67 per chair



### 7190005 UNDERSEAT WOOD PANEL

W: 18" D: 19" WT: 1 lb  
\$99

Panels with vinyl or crypton upholstered seats will be drilled for ventilation. Available for standard width Plylok chairs only.



### 7190006 UNDERSEAT WOOD PANEL, 2" NARROWER MODELS

W: 18" D: 19" WT: 1 lb  
\$99

Panels with vinyl or crypton upholstered seats will be drilled for ventilation. Available for 2" narrower Plylok chairs only.



### 7070011 2" PLASTIC LEG PROTECTOR (SET OF FOUR)

\$80



### 7070018 PLASTIC LEG PROTECTOR, CLEAR (SET OF TWO)

\$40

# Pose



## 243144 COUNTER STOOL

W: 17.75" D: 20.25" H: 24" SW: 13" SD: - SH: - AH: - WT: 8 lb COM: .25 yd WT CAP: 300 lb

ZONE	B/COM	C	D	E	F	G	H	I	J	GENERAL INFORMATION
1	777	782	787	793	803	813	823	832	842	MATERIAL: Metal MOIS. BARR: -
2	796	801	806	812	822	832	842	851	861	
3	816	821	826	832	842	852	862	871	881	
4	835	840	845	851	861	871	881	890	900	



## 243147 BAR STOOL

W: 17.75" D: 20.5" H: 30" SW: 13" SD: - SH: - AH: - WT: 9 lb COM: .25 yd WT CAP: 300 lb

ZONE	B/COM	C	D	E	F	G	H	I	J	GENERAL INFORMATION
1	795	800	805	811	821	831	841	850	860	MATERIAL: Metal MOIS. BARR: -
2	815	820	825	831	841	851	861	870	880	
3	835	840	845	851	861	871	881	890	900	
4	854	859	864	870	880	890	900	909	919	

*Specify:*

- Product Number
- Metal Finish
- Fabric Vendor, Pattern and Color

**See pages 16 & 17 for material and finish options.**

# Rally

## LEG OPTIONS – SEATING AND SQUARE OTTOMAN

<p>Wood Leg (no upcharge)</p> 	<p>Round Metal (no upcharge)</p> 	<p>Square Metal (no upcharge)</p> 	<p>Sled Base (upcharge)</p> 	<p>Mobility (upcharge)</p> 
<p><i>Metal feet available in silver color only.</i></p>			<p>\$261 Compose or Privacy Corner Loveseat \$197 Compose w/1 Arm \$390 Privacy Booth w/Table \$132 All Other Models <i>Not available on round ottomans. A layout is required if specifying on a corner unit.</i></p>	<p>\$627 Compose \$473 Compose w/1 Arm \$305 All Other Models <i>Not available on loveseat, sofa, or privacy models.</i></p>

## LEG OPTIONS – ROUND OTTOMANS

<p>Wood (no upcharge)</p> 	<p>Metal Round (no upcharge)</p> 	<p>Metal Square (no upcharge)</p> 	<p>Sled Foot \$201</p> 	<p>Casters \$384</p> 
<p><i>Metal feet available in silver color only.</i></p>			<p><i>5 per Ottoman.</i></p>	

## ARM CAP OPTIONS

Arm Cap \$332 (pair)  
\$169 (single)



*Thermoform only. Only available on Embrace models.*

## BACK OPTIONS

Back Cap \$114



\$302 Corner Unit  
*Not available on loveseat, sofa or mid-back models.*

## MID-BACK OPTIONS

Mid-back



\$166 Chair Models  
\$336 Loveseat Models  
\$498 Sofa Models  
Overall height 35".

Mid-back Corner  
64441 \$336



Overall height 35".  
COM: 0.5 yd

Mid-back Wedge  
Inside \$239



Overall height 35".  
COM: 0.25 yd

Mid-back Wedge  
Outside \$129



Overall height 35".  
COM: 0.25 yd

*Fabric zoning not recommended when using mid back with Indulge models.*

## OTTOMAN & TABLE TOP OTTOMANS OPTIONS

Upholstered  
(no upcharge)



H: 18" WT: 47 lb

Standard Height



H: 16.25" WT: 75 lb  
\$1585 Thermoform  
\$1563 Laminate

Low Table Top  
Square



H: 15"  
\$566 Thermoform  
\$757 Laminate

Low Table Top  
Wedge



H: 18"  
\$495 Thermoform  
\$730 Laminate

Low Table Top  
Round



Thermoform:  
22" 30" 36"  
\$252 \$419 \$668  
Laminate:  
22" 30" 36"  
\$383 \$614 \$914

## LAMINATE TOP OPTIONS

Compose Arm \$588 (pair)  
\$294 (single)



*Thermoform comes standard (no upcharge).*

Coffee Table Ottoman  
\$284



Integrated Table  
\$192



Round End Table  
Ottoman \$140



*Low Table Top is standard on 22" Round End Table Ottoman (6422-ET-OT) without an upcharge. Upholstered top not available on 22" Round End Table Ottoman.*

## POWER OPTIONS

USB/120V Outlet  
\$829



120V/120V Outlet  
\$701



OR

USB/120V Double  
Outlet \$1658



120V/120V Double  
Outlet \$1402



OR

*For chairs with table arm. Must specify black or silver. Cord length is 12'.*

*For Compose models with two table arms, wedge table and table top ottomans. Must specify black or silver. Cord length is 12'. Not available on Coffee Table Top Ottoman or Round Ottomans.*

## GANGING OPTION

\$75 Aspire and Indulge w/1 Arm

\$114 All other Chairs, Loveseats, Sofas and Wedge Ottomans

\$200 Square Ottomans

# Rally Aspire



## 64331HC ASPIRE CHAIR

W: 34.25" D: 31" H: 31" SW: 23" SD: 21" SH: 18" AH: 26.5" WT: 62 lb COM: 6.25 yd WT CAP: 400 lb

ZONE	B/COM	C	D	E	F	G	H	I	J	GENERAL INFORMATION
1	3586	3711	3830	3980	4230	4474	4724	4967	5217	MATERIAL: Maple MOIS. BARR: Included
2	3673	3798	3917	4067	4317	4561	4811	5054	5304	
3	3760	3885	4004	4154	4404	4648	4898	5141	5391	
4	3847	3972	4091	4241	4491	4735	4985	5228	5478	

See beginning of section for details on standard and optional items and pricing. Cannot be ganged.



## 64131HC ASPIRE CHAIR WITH 1 UPH ARM

W: 28.75" D: 31" H: 31" SW: 23" SD: 21" SH: 18" AH: 26.5" WT: 49 lb COM: 5 yd WT CAP: 400 lb

ZONE	B/COM	C	D	E	F	G	H	I	J	GENERAL INFORMATION
1	3310	3410	3505	3625	3825	4020	4220	4415	4615	MATERIAL: Maple MOIS. BARR: Included
2	3391	3491	3586	3706	3906	4101	4301	4496	4696	
3	3472	3572	3667	3787	3987	4182	4382	4577	4777	
4	3552	3652	3747	3867	4067	4262	4462	4657	4857	

When ordering, specify arm location (right or left) as facing the unit. Please use code RA (right arm) or LA (left arm). Ganging is available. See beginning of section for details on standard and optional items and pricing.



## 64332HC ASPIRE LOVESEAT

W: 57.25" D: 31" H: 31" SW: 46" SD: 21" SH: 18" AH: 26.5" WT: 90 lb COM: 8.5 yd WT CAP: 600 lb

ZONE	B/COM	C	D	E	F	G	H	I	J	GENERAL INFORMATION
1	5565	5735	5897	6101	6441	6772	7112	7444	7784	MATERIAL: Maple MOIS. BARR: Included
2	5701	5871	6033	6237	6577	6908	7248	7580	7920	
3	5836	6006	6168	6372	6712	7043	7383	7715	8055	
4	5972	6142	6304	6508	6848	7179	7519	7851	8191	

See beginning of section for details on standard and optional items and pricing. Cannot be ganged.



## 64132HC ASPIRE LOVESEAT WITH 1 UPH ARM

W: 51.75" D: 31" H: 31" SW: 46" SD: 21" SH: 18" AH: 26.5" WT: 79 lb COM: 7.25 yd WT CAP: 600 lb

ZONE	B/COM	C	D	E	F	G	H	I	J	GENERAL INFORMATION
1	5296	5441	5579	5753	6043	6326	6616	6898	7188	MATERIAL: Maple MOIS. BARR: Included
2	5426	5571	5709	5883	6173	6456	6746	7028	7318	
3	5555	5700	5838	6012	6302	6585	6875	7157	7447	
4	5684	5829	5967	6141	6431	6714	7004	7286	7576	

When ordering, specify arm location (right or left) as facing the unit. Please use code RA (right arm) or LA (left arm). See beginning of section for details on standard and optional items and pricing. Ganging is available.



## 64333HC ASPIRE SOFA

W: 80.25" D: 31" H: 31" SW: 69" SD: 21" SH: 18" AH: 26.5" WT: 125 lb COM: 10.75 yd WT CAP: 700 lb

ZONE	B/COM	C	D	E	F	G	H	I	J	GENERAL INFORMATION
1	7179	7394	7598	7856	8286	8706	9136	9555	9985	MATERIAL: Maple MOIS. BARR: Included
2	7354	7569	7773	8031	8461	8881	9311	9730	10160	
3	7529	7744	7948	8206	8636	9056	9486	9905	10335	
4	7705	7920	8124	8382	8812	9232	9662	10081	10511	

See beginning of section for details on standard and optional items and pricing. Cannot be ganged.



## 64133HC ASPIRE SOFA WITH 1 UPH ARM

W: 74.75" D: 31" H: 31" SW: 69" SD: 21" SH: 18" AH: 26.5" WT: 114 lb COM: 9.5 yd WT CAP: 700 lb

ZONE	B/COM	C	D	E	F	G	H	I	J	GENERAL INFORMATION
1	6908	7098	7279	7507	7887	8257	8637	9008	9388	MATERIAL: Maple MOIS. BARR: Included
2	7077	7267	7448	7676	8056	8426	8806	9177	9557	
3	7246	7436	7617	7845	8225	8595	8975	9346	9726	
4	7415	7605	7786	8014	8394	8764	9144	9515	9895	

When ordering, specify arm location (right or left) as facing the unit. Please use code RA (right arm) or LA (left arm). Ganging is available. See beginning of section for details on standard and optional items and pricing.

Specify:

Product Number

Arm Location

Fabric Vendor, Pattern and Color

Leg Option

Wood Option Only:

Wood Finish

See pages 16 & 17 for material and finish options.

# Rally Embrace



## 64311HC EMBRACE CHAIR

W: 30" D: 31" H: 31" SW: 23" SD: 21" SH: 18" AH: 26" WT: 60 lb COM: 6.25 yd WT CAP: 400 lb

ZONE	B/COM	C	D	E	F	G	H	I	J	GENERAL INFORMATION
1	3562	3687	3806	3956	4206	4450	4700	4943	5193	MATERIAL: Maple
2	3649	3774	3893	4043	4293	4537	4787	5030	5280	MOIS. BARR: Included
3	3735	3860	3979	4129	4379	4623	4873	5116	5366	
4	3822	3947	4066	4216	4466	4710	4960	5203	5453	

Ganging is available. See beginning of section for details on standard and optional items and pricing.



## 64111HC EMBRACE CHAIR WITH 1 UPH ARM

W: 26.5" D: 31" H: 31" SW: 23" SD: 21" SH: 18" AH: 26" WT: 49 lb COM: 4.75 yd WT CAP: 400 lb

ZONE	B/COM	C	D	E	F	G	H	I	J	GENERAL INFORMATION
1	3281	3376	3466	3580	3770	3956	4146	4331	4521	MATERIAL: Maple
2	3361	3456	3546	3660	3850	4036	4226	4411	4601	MOIS. BARR: Included
3	3441	3536	3626	3740	3930	4116	4306	4491	4681	
4	3521	3616	3706	3820	4010	4196	4386	4571	4761	

When ordering, specify arm location (right or left) as facing the unit. Please use code RA (right arm) or LA (left arm). Ganging is available. See beginning of section for details on standard and optional items and pricing.



## 64312HC EMBRACE LOVESEAT

W: 53" D: 31" H: 31" SW: 46" SD: 21" SH: 18" AH: 26" WT: 96 lb COM: 8.5 yd WT CAP: 600 lb

ZONE	B/COM	C	D	E	F	G	H	I	J	GENERAL INFORMATION
1	5528	5698	5860	6064	6404	6735	7075	7407	7747	MATERIAL: Maple
2	5663	5833	5995	6199	6539	6870	7210	7542	7882	MOIS. BARR: Included
3	5798	5968	6130	6334	6674	7005	7345	7677	8017	
4	5932	6102	6264	6468	6808	7139	7479	7811	8151	

Ganging is available. See beginning of section for details on standard and optional items and pricing.



## 64112HC EMBRACE LOVESEAT WITH 1 UPH ARM

W: 49.5" D: 31" H: 31" SW: 46" SD: 21" SH: 18" AH: 26" WT: 82 lb COM: 6.75 yd WT CAP: 600 lb

ZONE	B/COM	C	D	E	F	G	H	I	J	GENERAL INFORMATION
1	5251	5391	5524	5692	5972	6245	6525	6798	7078	MATERIAL: Maple
2	5379	5519	5652	5820	6100	6373	6653	6926	7206	MOIS. BARR: Included
3	5508	5648	5781	5949	6229	6502	6782	7055	7335	
4	5636	5776	5909	6077	6357	6630	6910	7183	7463	

When ordering, specify arm location (right or left) as facing the unit. Please use code RA (right arm) or LA (left arm). Ganging is available. See beginning of section for details on standard and optional items and pricing.



## 64313HC EMBRACE SOFA

W: 76" D: 31" H: 31" SW: 69" SD: 21" SH: 18" AH: 26" WT: 131 lb COM: 10.75 yd WT CAP: 700 lb

ZONE	B/COM	C	D	E	F	G	H	I	J	GENERAL INFORMATION
1	7128	7343	7547	7805	8235	8655	9085	9504	9934	MATERIAL: Maple
2	7302	7517	7721	7979	8409	8829	9259	9678	10108	MOIS. BARR: Included
3	7476	7691	7895	8153	8583	9003	9433	9852	10282	
4	7650	7865	8069	8327	8757	9177	9607	10026	10456	

Ganging is available. See beginning of section for details on standard and optional items and pricing.

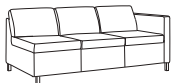

## 64113HC EMBRACE SOFA WITH 1 UPH ARM

W: 72.5" D: 31" H: 31" SW: 69" SD: 21" SH: 18" AH: 26" WT: 117 lb COM: 9.25 yd WT CAP: 700 lb

ZONE	B/COM	C	D	E	F	G	H	I	J	GENERAL INFORMATION
1	6849	7034	7210	7432	7802	8163	8533	8893	9263	MATERIAL: Maple
2	7017	7202	7378	7600	7970	8331	8701	9061	9431	MOIS. BARR: Included
3	7184	7369	7545	7767	8137	8498	8868	9228	9598	
4	7352	7537	7713	7935	8305	8666	9036	9396	9766	

When ordering, specify arm location (right or left) as facing the unit. Please use code RA (right arm) or LA (left arm). Ganging is available. See beginning of section for details on standard and optional items and pricing.

**Specify:**

- Product Number
- Arm Location
- Fabric Vendor, Pattern and Color
- Leg Option
- Wood Option Only:
  - Wood Finish

See pages 16 & 17 for material and finish options.

# Rally Indulge



## 64321HC INDULGE CHAIR

W: 34"	D: 31"	H: 31"	SW: 23"	SD: 21"	SH: 18"	AH: 23.5"	WT: 60 lb	COM: 5.5 yd	WT CAP: 400 lb	
ZONE	B/COM	C	D	E	F	G	H	I	J	GENERAL INFORMATION
1	3550	3660	3765	3897	4117	4331	4551	4766	4986	MATERIAL: Maple
2	3637	3747	3852	3984	4204	4418	4638	4853	5073	MOIS. BARR: Included
3	3723	3833	3938	4070	4290	4504	4724	4939	5159	
4	3810	3920	4025	4157	4377	4591	4811	5026	5246	

Cannot be ganged. See beginning of section for details on standard and optional items and pricing.



## 64121HC INDULGE CHAIR WITH 1 UPH ARM

W: 28.5"	D: 31"	H: 31"	SW: 23"	SD: 21"	SH: 18"	AH: 23.5"	WT: 49 lb	COM: 4.5 yd	WT CAP: 400 lb	
ZONE	B/COM	C	D	E	F	G	H	I	J	GENERAL INFORMATION
1	3277	3367	3453	3561	3741	3916	4096	4272	4452	MATERIAL: Maple
2	3357	3447	3533	3641	3821	3996	4176	4352	4532	MOIS. BARR: Included
3	3437	3527	3613	3721	3901	4076	4256	4432	4612	
4	3517	3607	3693	3801	3981	4156	4336	4512	4692	

When ordering, specify arm location (right or left) as facing the unit. Please use code RA (right arm) or LA (left arm). Ganging is available. See beginning of section for details on standard and optional items and pricing.



## 64322HC INDULGE LOVESEAT

W: 57"	D: 31"	H: 31"	SW: 46"	SD: 21"	SH: 18"	AH: 23.5"	WT: 94 lb	COM: 8.25 yd	WT CAP: 600 lb	
ZONE	B/COM	C	D	E	F	G	H	I	J	GENERAL INFORMATION
1	5520	5680	5832	6024	6344	6656	6976	7288	7608	MATERIAL: Maple
2	5655	5815	5967	6159	6479	6791	7111	7423	7743	MOIS. BARR: Included
3	5790	5950	6102	6294	6614	6926	7246	7558	7878	
4	5924	6084	6236	6428	6748	7060	7380	7692	8012	

Cannot be ganged. See beginning of section for details on standard and optional items and pricing.



## 64122HC INDULGE LOVESEAT WITH 1 UPH ARM

W: 51.5"	D: 31"	H: 31"	SW: 46"	SD: 21"	SH: 18"	AH: 23.5"	WT: 81 lb	COM: 6.75 yd	WT CAP: 600 lb	
ZONE	B/COM	C	D	E	F	G	H	I	J	GENERAL INFORMATION
1	5251	5391	5524	5692	5972	6245	6525	6798	7078	MATERIAL: Maple
2	5379	5519	5652	5820	6100	6373	6653	6926	7206	MOIS. BARR: Included
3	5508	5648	5781	5949	6229	6502	6782	7055	7335	
4	5636	5776	5909	6077	6357	6630	6910	7183	7463	

When ordering, specify arm location (right or left) as facing the unit. Please use code RA (right arm) or LA (left arm). Ganging is available. See beginning of section for details on standard and optional items and pricing.



## 64323HC INDULGE SOFA

W: 80"	D: 31"	H: 31"	SW: 69"	SD: 21"	SH: 18"	AH: 23.5"	WT: 129 lb	COM: 10.25 yd	WT CAP: 700 lb	
ZONE	B/COM	C	D	E	F	G	H	I	J	GENERAL INFORMATION
1	7120	7325	7520	7766	8176	8576	8986	9385	9795	MATERIAL: Maple
2	7294	7499	7694	7940	8350	8750	9160	9559	9969	MOIS. BARR: Included
3	7468	7673	7868	8114	8524	8924	9334	9733	10143	
4	7642	7847	8042	8288	8698	9098	9508	9907	10317	

Cannot be ganged. See beginning of section for details on standard and optional items and pricing.



## 64123HC INDULGE SOFA WITH 1 UPH ARM

W: 74.5"	D: 31"	H: 31"	SW: 69"	SD: 21"	SH: 18"	AH: 23.5"	WT: 116 lb	COM: 9.25 yd	WT CAP: 700 lb	
ZONE	B/COM	C	D	E	F	G	H	I	J	GENERAL INFORMATION
1	6849	7034	7210	7432	7802	8163	8533	8893	9263	MATERIAL: Maple
2	7017	7202	7378	7600	7970	8331	8701	9061	9431	MOIS. BARR: Included
3	7184	7369	7545	7767	8137	8498	8868	9228	9598	
4	7352	7537	7713	7935	8305	8666	9036	9396	9766	

When ordering, specify arm location (right or left) as facing the unit. Please use code RA (right arm) or LA (left arm). Ganging is available. See beginning of section for details on standard and optional items and pricing.

**Specify:**

Product Number

Arm Location

Fabric Vendor, Pattern and Color

Leg Option

Wood Option Only:

Wood Finish

**See pages 16 & 17 for material and finish options.**

# Rally Compose



## 64341HC COMPOSE CHAIR

W: 46" D: 31" H: 31" SW: 23" SD: 21" SH: 18" AH: 26" WT: 116 lb COM: 6.25 yd WT CAP: 400 lb

ZONE	B/COM	C	D	E	F	G	H	I	J	GENERAL INFORMATION
1	6636	6761	6880	7030	7280	7524	7774	8017	8267	MATERIAL: Maple
2	6799	6924	7043	7193	7443	7687	7937	8180	8430	MOIS. BARR: Included
3	6963	7088	7207	7357	7607	7851	8101	8344	8594	
4	7126	7251	7370	7520	7770	8014	8264	8507	8757	

Specify material and finish when ordering. Ganging is available. Power is available on both arms. See beginning of section for details on standard and optional items and pricing.



## 64141HC COMPOSE CHAIR WITH 1 TABLE ARM

W: 34.5" D: 31" H: 31" SW: 23" SD: 21" SH: 18" AH: 26" WT: 77 lb COM: 4.75 yd WT CAP: 400 lb

ZONE	B/COM	C	D	E	F	G	H	I	J	GENERAL INFORMATION
1	4534	4629	4719	4833	5023	5209	5399	5584	5774	MATERIAL: Maple
2	4645	4740	4830	4944	5134	5320	5510	5695	5885	MOIS. BARR: Included
3	4757	4852	4942	5056	5246	5432	5622	5807	5997	
4	4868	4963	5053	5167	5357	5543	5733	5918	6108	

When ordering, specify table arm location (right or left) as facing the unit. Please use code LT (left table) or RT (right table). Specify material and finish when ordering. Ganging is available. Power is available. See beginning of section for details on standard and optional items and pricing.



## 64342HC COMPOSE LOVESEAT

W: 69" D: 31" H: 31" SW: 46" SD: 21" SH: 18" AH: 26" WT: 120 lb COM: 8.5 yd WT CAP: 600 lb

ZONE	B/COM	C	D	E	F	G	H	I	J	GENERAL INFORMATION
1	7830	8000	8162	8366	8706	9037	9377	9709	10049	MATERIAL: Maple
2	8022	8192	8354	8558	8898	9229	9569	9901	10241	MOIS. BARR: Included
3	8215	8385	8547	8751	9091	9422	9762	10094	10434	
4	8407	8577	8739	8943	9283	9614	9954	10286	10626	

Specify material and finish when ordering. Ganging is available. Power is available. See beginning of section for details on standard and optional items and pricing.



## 64142HC COMPOSE LOVESEAT WITH 1 TABLE ARM

W: 57.5" D: 31" H: 31" SW: 46" SD: 21" SH: 18" AH: 26" WT: 94 lb COM: 7 yd WT CAP: 600 lb

ZONE	B/COM	C	D	E	F	G	H	I	J	GENERAL INFORMATION
1	5769	5909	6042	6210	6490	6763	7043	7316	7596	MATERIAL: Maple
2	5910	6050	6183	6351	6631	6904	7184	7457	7737	MOIS. BARR: Included
3	6052	6192	6325	6493	6773	7046	7326	7599	7879	
4	6193	6333	6466	6634	6914	7187	7467	7740	8020	

When ordering, specify table arm location (right or left) as facing the unit. Please use code LT (left table) or RT (right table). Specify material and finish when ordering. Ganging is available. Power is available. See beginning of section for details on standard and optional items and pricing.

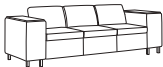

## 64343HC COMPOSE SOFA

W: 92" D: 31" H: 31" SW: 69" SD: 21" SH: 18" AH: 26" WT: 120 lb COM: 11 yd WT CAP: 700 lb

ZONE	B/COM	C	D	E	F	G	H	I	J	GENERAL INFORMATION
1	8919	9139	9348	9612	10052	10481	10921	11350	11790	MATERIAL: Maple
2	9138	9358	9567	9831	10271	10700	11140	11569	12009	MOIS. BARR: Included
3	9356	9576	9785	10049	10489	10918	11358	11787	12227	
4	9575	9795	10004	10268	10708	11137	11577	12006	12446	

Specify material and finish when ordering. Ganging is available. Power is available. See beginning of section for details on standard and optional items and pricing.

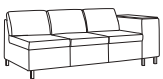

## 64143HC COMPOSE SOFA WITH 1 TABLE ARM

W: 80.5" D: 31" H: 31" SW: 69" SD: 21" SH: 18" AH: 26" WT: 129 lb COM: 9.5 yd WT CAP: 700 lb

ZONE	B/COM	C	D	E	F	G	H	I	J	GENERAL INFORMATION
1	6860	7050	7231	7459	7839	8209	8589	8960	9340	MATERIAL: Maple
2	7028	7218	7399	7627	8007	8377	8757	9128	9508	MOIS. BARR: Included
3	7195	7385	7566	7794	8174	8544	8924	9295	9675	
4	7363	7553	7734	7962	8342	8712	9092	9463	9843	

When ordering, specify table arm location (right or left) as facing the unit. Please use code LT (left table) or RT (right table). Specify material and finish when ordering. Ganging is available. Power is available. See beginning of section for details on standard and optional items and pricing.

**Specify:**

- Product Number
- Arm Location
- Fabric Vendor, Pattern and Color
- Thermoform Finish
- Laminated Finish
- Leg Option
- Power Option and Color
- Wood Option Only:
  - Wood Finish

See pages 16 & 17 for material and finish options.

# Rally Compose with Embrace



## 64241HC COMPOSE CHAIR WITH TABLE ARM AND EMBRACE ARM

W: 38" D: 31" H: 31" SW: 23" SD: 21" SH: 18" AH: 26" WT: 89 lb COM: 6.25 yd WT CAP: 400 lb

ZONE	B/COM	C	D	E	F	G	H	I	J	GENERAL INFORMATION
1	5381	5506	5625	5775	6025	6269	6519	6762	7012	MATERIAL: Maple
2	5513	5638	5757	5907	6157	6401	6651	6894	7144	MOIS. BARR: Included
3	5645	5770	5889	6039	6289	6533	6783	7026	7276	
4	5777	5902	6021	6171	6421	6665	6915	7158	7408	

When ordering, specify arm and table location (right or left) as facing the unit. Please use code LART (left arm, right table) or LTRA (left table, right arm). Specify material and finish when ordering. Power is available. See beginning of section for details on standard and optional items and pricing.



## 64242HC COMPOSE LOVESEAT WITH TABLE ARM AND EMBRACE ARM

W: 61" D: 31" H: 31" SW: 46" SD: 21" SH: 18" AH: 26" WT: 108 lb COM: 8.5 yd WT CAP: 600 lb

ZONE	B/COM	C	D	E	F	G	H	I	J	GENERAL INFORMATION
1	6598	6768	6930	7134	7474	7805	8145	8477	8817	MATERIAL: Maple
2	6760	6930	7092	7296	7636	7967	8307	8639	8979	MOIS. BARR: Included
3	6921	7091	7253	7457	7797	8128	8468	8800	9140	
4	7083	7253	7415	7619	7959	8290	8630	8962	9302	

When ordering, specify arm and table arm location (right or left) as facing the unit. Please use code LTRA (left table, right arm) or LART (left arm, right table). Specify material and finish when ordering. Ganging is available. Power is available. See beginning of section for details on standard and optional items and pricing.

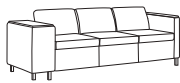

## 64243HC COMPOSE SOFA WITH TABLE ARM AND EMBRACE ARM

W: 84" D: 31" H: 31" SW: 69" SD: 21" SH: 18" AH: 26" WT: 143 lb COM: 10.75 yd WT CAP: 700 lb

ZONE	B/COM	C	D	E	F	G	H	I	J	GENERAL INFORMATION
1	7684	7899	8103	8361	8791	9211	9641	10060	10490	MATERIAL: Maple
2	7872	8087	8291	8549	8979	9399	9829	10248	10678	MOIS. BARR: Included
3	8060	8275	8479	8737	9167	9587	10017	10436	10866	
4	8247	8462	8666	8924	9354	9774	10204	10623	11053	

When ordering, specify arm and table arm location (right or left) as facing the unit. Please use code LTRA (left table, right arm) or LART (left arm, right table). Specify material and finish when ordering. Ganging is available. Power is available. See beginning of section for details on standard and optional items and pricing.

**Specify:**

- Product Number
- Arm Location
- Fabric Vendor, Pattern and Color
- Thermoform Finish
- Laminate Finish
- Leg Option
- Power Option and Color

**Wood Option Only:**

- Wood Finish

**See pages 16 & 17 for material and finish options.**

# Rally Armless Universal



## 64401HC ARMLESS CHAIR

W: 23" D: 31" H: 31" SW: 23" SD: 21" SH: 18" AH: - WT: 38 lb COM: 3.5 yd WT CAP: 400 lb

ZONE	B/COM	C	D	E	F	G	H	I	J	GENERAL INFORMATION
1	2439	2509	2576	2660	2800	2936	3076	3213	3353	MATERIAL: Maple
2	2499	2569	2636	2720	2860	2996	3136	3273	3413	MOIS. BARR: Included
3	2558	2628	2695	2779	2919	3055	3195	3332	3472	
4	2618	2688	2755	2839	2979	3115	3255	3392	3532	

Ganging is available. See beginning of section for details on standard and optional items and pricing.



## 64402HC ARMLESS LOVESEAT

W: 46" D: 31" H: 31" SW: 46" SD: 21" SH: 18" AH: - WT: 68 lb COM: 5.5 yd WT CAP: 600 lb

ZONE	B/COM	C	D	E	F	G	H	I	J	GENERAL INFORMATION
1	3806	3921	4030	4168	4398	4623	4853	5077	5307	MATERIAL: Maple
2	3899	4014	4123	4261	4491	4716	4946	5170	5400	MOIS. BARR: Included
3	3992	4107	4216	4354	4584	4809	5039	5263	5493	
4	4085	4200	4309	4447	4677	4902	5132	5356	5586	

Ganging is available. See beginning of section for details on standard and optional items and pricing.



## 64403HC ARMLESS SOFA

W: 69" D: 31" H: 31" SW: 69" SD: 21" SH: 18" AH: - WT: 103 lb COM: 8 yd WT CAP: 700 lb

ZONE	B/COM	C	D	E	F	G	H	I	J	GENERAL INFORMATION
1	4915	5075	5227	5419	5739	6051	6371	6683	7003	MATERIAL: Maple
2	5035	5195	5347	5539	5859	6171	6491	6803	7123	MOIS. BARR: Included
3	5154	5314	5466	5658	5978	6290	6610	6922	7242	
4	5274	5434	5586	5778	6098	6410	6730	7042	7362	

Ganging is available. See beginning of section for details on standard and optional items and pricing.

## 64441HC CORNER CHAIR

W: 31" D: 31" H: 31" SW: 21" SD: 21" SH: 18" AH: - WT: 65 lb COM: 4.75 yd WT CAP: 400 lb

ZONE	B/COM	C	D	E	F	G	H	I	J	GENERAL INFORMATION
1	3684	3779	3869	3983	4173	4359	4549	4734	4924	MATERIAL: Maple
2	3774	3869	3959	4073	4263	4449	4639	4824	5014	MOIS. BARR: Included
3	3864	3959	4049	4163	4353	4539	4729	4914	5104	
4	3955	4050	4140	4254	4444	4630	4820	5005	5195	

Ganging is available. See beginning of section for details on standard and optional items and pricing. Use of patterned fabric on seat is not recommended.



## 64454HC INSIDE WEDGE CHAIR, 30-DEGREE ANGLE WITH WIDE BACK

W: 18-34" D: 30" H: 31" SW: - SD: - SH: 18" AH: - WT: 44 lb COM: 4.25 yd WT CAP: 400 lb

ZONE	B/COM	C	D	E	F	G	H	I	J	GENERAL INFORMATION
1	3044	3129	3210	3312	3482	3648	3818	3983	4153	MATERIAL: Maple
2	3118	3203	3284	3386	3556	3722	3892	4057	4227	MOIS. BARR: Included
3	3193	3278	3359	3461	3631	3797	3967	4132	4302	
4	3267	3352	3433	3535	3705	3871	4041	4206	4376	

Ganging is available. See beginning of section for details on standard and optional items and pricing. Use of patterned fabric on seat is not recommended.



## 64455HC OUTSIDE WEDGE CHAIR, 30-DEGREE ANGLE WITH NARROW BACK

W: 18-34" D: 30" H: 31" SW: - SD: - SH: 18" AH: - WT: 40 lb COM: 3.75 yd WT CAP: 400 lb

ZONE	B/COM	C	D	E	F	G	H	I	J	GENERAL INFORMATION
1	2781	2856	2927	3017	3167	3314	3464	3610	3760	MATERIAL: Maple
2	2849	2924	2995	3085	3235	3382	3532	3678	3828	MOIS. BARR: Included
3	2917	2992	3063	3153	3303	3450	3600	3746	3896	
4	2985	3060	3131	3221	3371	3518	3668	3814	3964	

Ganging is available. See beginning of section for details on standard and optional items and pricing. Use of patterned fabric on seat is not recommended.

**Specify:**

- Product Number
- Fabric Vendor, Pattern and Color
- Leg Option
- Wood Option Only:
- Wood Finish

See pages 16 & 17 for material and finish options.

# Rally Ottomans and Tables



## 64500 INTEGRATED TABLE

W: 22.5" D: 28.5" H: 26.75" SW: - SD: - SH: - AH: - WT: 63 lb COM: 1.75 yd WT CAP: -

ZONE	B/COM	C	D	E	F	G	H	I	J	GENERAL INFORMATION
1	3371	3406	3439	3481	3551	3620	3690	3758	3828	MATERIAL: Maple
2	3455	3490	3523	3565	3635	3704	3774	3842	3912	MOIS. BARR: Included
3	3538	3573	3606	3648	3718	3787	3857	3925	3995	
4	3622	3657	3690	3732	3802	3871	3941	4009	4079	

Table must be permanently attached to 2 units (armless on connection side). Must send in a layout with the order. Specify black or silver table leg when ordering. Casters are not available. Specify material and finish when ordering. Power is available. See beginning of section for details on standard and optional items and pricing.



## 64-OT OTTOMAN

W: 31" D: 31" H: 18" SW: - SD: - SH: - AH: - WT: 47 lb COM: 3 yd WT CAP: -

ZONE	B/COM	C	D	E	F	G	H	I	J	GENERAL INFORMATION
1	1722	1782	1839	1911	2031	2148	2268	2385	2505	MATERIAL: Maple
2	1764	1824	1881	1953	2073	2190	2310	2427	2547	MOIS. BARR: Included
3	1806	1866	1923	1995	2115	2232	2352	2469	2589	
4	1848	1908	1965	2037	2157	2274	2394	2511	2631	

Ottoman with low table top is available at an additional charge. Specify material and finish when ordering. Ganging is available. See beginning of section for details on standard and optional items and pricing.



## 64-CT-OT COFFEE TABLE OTTOMAN

W: 31" D: 31" H: 21" SW: - SD: - SH: - AH: - WT: 75 lb COM: 2 yd WT CAP: -

ZONE	B/COM	C	D	E	F	G	H	I	J	GENERAL INFORMATION
1	4183	4223	4261	4309	4389	4467	4547	4625	4705	MATERIAL: Maple
2	4287	4327	4365	4413	4493	4571	4651	4729	4809	MOIS. BARR: Included
3	4391	4431	4469	4517	4597	4675	4755	4833	4913	
4	4494	4534	4572	4620	4700	4778	4858	4936	5016	

Specify material and finish when ordering. Ganging is available. See beginning of section for details on standard and optional items and pricing. Not available with power option.



## 64-WG-OT WEDGE OTTOMAN, 30-DEGREE ANGLE

W: 18-34" D: 30" H: 18" SW: - SD: - SH: - AH: - WT: 35 lb COM: 3.5 yd WT CAP: -

ZONE	B/COM	C	D	E	F	G	H	I	J	GENERAL INFORMATION
1	1832	1892	1949	2021	2141	2258	2378	2495	2615	MATERIAL: Maple
2	1877	1937	1994	2066	2186	2303	2423	2540	2660	MOIS. BARR: Included
3	1921	1981	2038	2110	2230	2347	2467	2584	2704	
4	1966	2026	2083	2155	2275	2392	2512	2629	2749	

Low table top option available; specify material and finish when ordering. Power options available. Height is 15" with table top. Specify material and finish when ordering. Ganging is available on sides only. See beginning of section for details on standard and optional items and pricing.



## 64550 WEDGE TABLE, 30-DEGREE ANGLE

W: 18-34" D: 30" H: 26" SW: - SD: - SH: - AH: - WT: 67 lb COM: 2.75 yd WT CAP: -

ZONE	B/COM	C	D	E	F	G	H	I	J	GENERAL INFORMATION
1	2510	2565	2617	2683	2793	2901	3011	3118	3228	MATERIAL: Maple
2	2572	2627	2679	2745	2855	2963	3073	3180	3290	MOIS. BARR: Included
3	2633	2688	2740	2806	2916	3024	3134	3241	3351	
4	2695	2750	2802	2868	2978	3086	3196	3303	3413	

Specify material and finish when ordering. Ganging is available on sides only. See beginning of section for details on standard and optional items and pricing.

### Specify:

- Product Number
- Fabric Vendor, Pattern and Color
- Thermoform Finish
- Laminate Finish
- Leg Option
- Power Option and Color

### Wood Option Only:

- Wood Finish

See pages 16 & 17 for material and finish options.

# Rally Ottomans and Tables



## 6422-OT 22" ROUND OTTOMAN

W: 22" D: 22" H: 18" SW: - SD: - SH: - AH: - WT: 26 lb COM: 1.5 yd WT CAP: -

ZONE	B/COM	C	D	E	F	G	H	I	J	GENERAL INFORMATION
1	2187	2217	2246	2282	2342	2400	2460	2519	2579	MATERIAL: Maple
2	2241	2271	2300	2336	2396	2454	2514	2573	2633	MOIS. BARR: Included
3	2295	2325	2354	2390	2450	2508	2568	2627	2687	
4	2349	2379	2408	2444	2504	2562	2622	2681	2741	

Low table top option available; specify material and finish when ordering. Height is 15" with table top. Power and ganging options not available. See beginning of section for details on standard and optional items and pricing.



## 6430-OT 30" ROUND OTTOMAN

W: 30" D: 30" H: 18" SW: - SD: - SH: - AH: - WT: 34 lb COM: 2.75 yd WT CAP: -

ZONE	B/COM	C	D	E	F	G	H	I	J	GENERAL INFORMATION
1	2565	2620	2672	2738	2848	2956	3066	3173	3283	MATERIAL: Maple
2	2628	2683	2735	2801	2911	3019	3129	3236	3346	MOIS. BARR: Included
3	2691	2746	2798	2864	2974	3082	3192	3299	3409	
4	2754	2809	2861	2927	3037	3145	3255	3362	3472	

Low table top option available; specify material and finish when ordering. Height is 15" with table top. Power and ganging options not available. See beginning of section for details on standard and optional items and pricing.

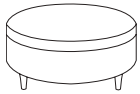

## 6436-OT 36" ROUND OTTOMAN

W: 36" D: 36" H: 18" SW: - SD: - SH: - AH: - WT: 44 lb COM: 3 yd WT CAP: -

ZONE	B/COM	C	D	E	F	G	H	I	J	GENERAL INFORMATION
1	2932	2992	3049	3121	3241	3358	3478	3595	3715	MATERIAL: Maple
2	3004	3064	3121	3193	3313	3430	3550	3667	3787	MOIS. BARR: Included
3	3076	3136	3193	3265	3385	3502	3622	3739	3859	
4	3148	3208	3265	3337	3457	3574	3694	3811	3931	

Low table top option available; specify material and finish when ordering. Height is 15" with table top. Power and ganging options not available. See beginning of section for details on standard and optional items and pricing.



## 6422-ET-OT 22" ROUND END TABLE

W: 22" D: 22" H: 22" SW: - SD: - SH: - AH: - WT: 34 lb COM: 1.5 yd WT CAP: -

ZONE	B/COM	C	D	E	F	G	H	I	J	GENERAL INFORMATION
1	2501	2531	2560	2596	2656	2714	2774	2833	2893	MATERIAL: Maple
2	2563	2593	2622	2658	2718	2776	2836	2895	2955	MOIS. BARR: Included
3	2625	2655	2684	2720	2780	2838	2898	2957	3017	
4	2687	2717	2746	2782	2842	2900	2960	3019	3079	

Specify material and finish when ordering. Power and ganging options not available. See beginning of section for details on standard and optional items and pricing.

**Specify:**

- Product Number
- Fabric Vendor, Pattern and Color
- Thermoform Finish
- Laminate Finish
- Leg Option
- Power Option and Color

**Wood Option Only:**

- Wood Finish

**See pages 16 & 17 for material and finish options.**

**CLASSIC (FULL FRONT)**



621 Series



621T Series

**CUSTOM (SEAT CUSHION WITH BASE OPTIONS)**



622 Series



622T Series

**ARM CAP OPTIONS**



Upholstered  
(no upcharge)



Wood  
(no upcharge)



Thermoform  
(no upcharge)



Urethane  
(no upcharge)

Specify black, sable or dove.



Solid Surface  
\$340

Specify solid surface color.

**LEG STYLES**



Wood Leg  
(standard)

There is no wood trim rail on custom models.



Metal Leg  
\$514

Specify silver, black, bronze or gunmetal.



Casters  
\$555

Available with or without a table. For table models, specify wood or metal center feet. Casters are intended to aid housekeeping staff with moving when cleaning.

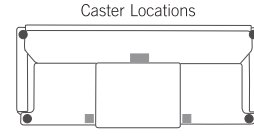

■ = table base  
● = casters ■ = foot

**BASE OPTIONS - FOR CUSTOM STYLES ONLY**



Ottoman  
\$1102

Specify left or right and select wood or urethane handle (as facing).



Drawer - Fabric, Wood or Thermoform  
\$442

Specify left, middle or right.



Blank Panel  
Fabric  
(no upcharge)

Specify left, middle or right.



Blank Panel  
Wood or Thermoform  
\$116

Specify left, middle or right.

**POWER OPTIONS - FOR CLASSIC STYLE WITH TABLE AND CUSTOM STYLE WITH TABLE ONLY**



7700001 USB/120V  
Outlet \$829

OR



7700002 120V/120V  
Outlet \$701



USB/120V Double  
Outlet \$1658



120V/120V Double  
Outlet \$1402

Available in black or silver. Usable cord length is 9'. Please get facility approval on power options before ordering. Specify right, left, or both. Power units are UL Listed Tamper Resistant outlets.

**SLEEP SURFACE OPTIONS**

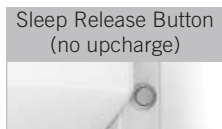

Sleep Release Button  
(no upcharge)

Specify dark bronze, light grey or black. Specify right or left (right is default unless otherwise specified).

**TABLE OPTIONS**

**Thermoform Table Top**  
(no upcharge)



*Specify thermoform color.*

**Solid Surface Table Top**



*Specify solid surface color.*

63" .....	\$708
66" .....	\$947
69" .....	\$1196
72" .....	\$1345
75" .....	\$1709
78" .....	\$1823

**Wood Column Skirt Cap**  
(no upcharge)



*Specify wood finish.*

**Thermoform Column Skirt Cap**  
(no upcharge)



*Specify thermoform color.*

**Solid Surface Skirt Cap**

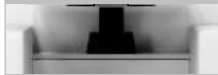

*Specify solid surface color.*

63" .....	\$266
66" .....	\$349
69" .....	\$352
72" .....	\$352
75" .....	\$435
78" .....	\$435

**Table Release Lever**  
(no upcharge)



*Specify silver, black, bronze or gunmetal.*

**OPTIONS LEGEND**

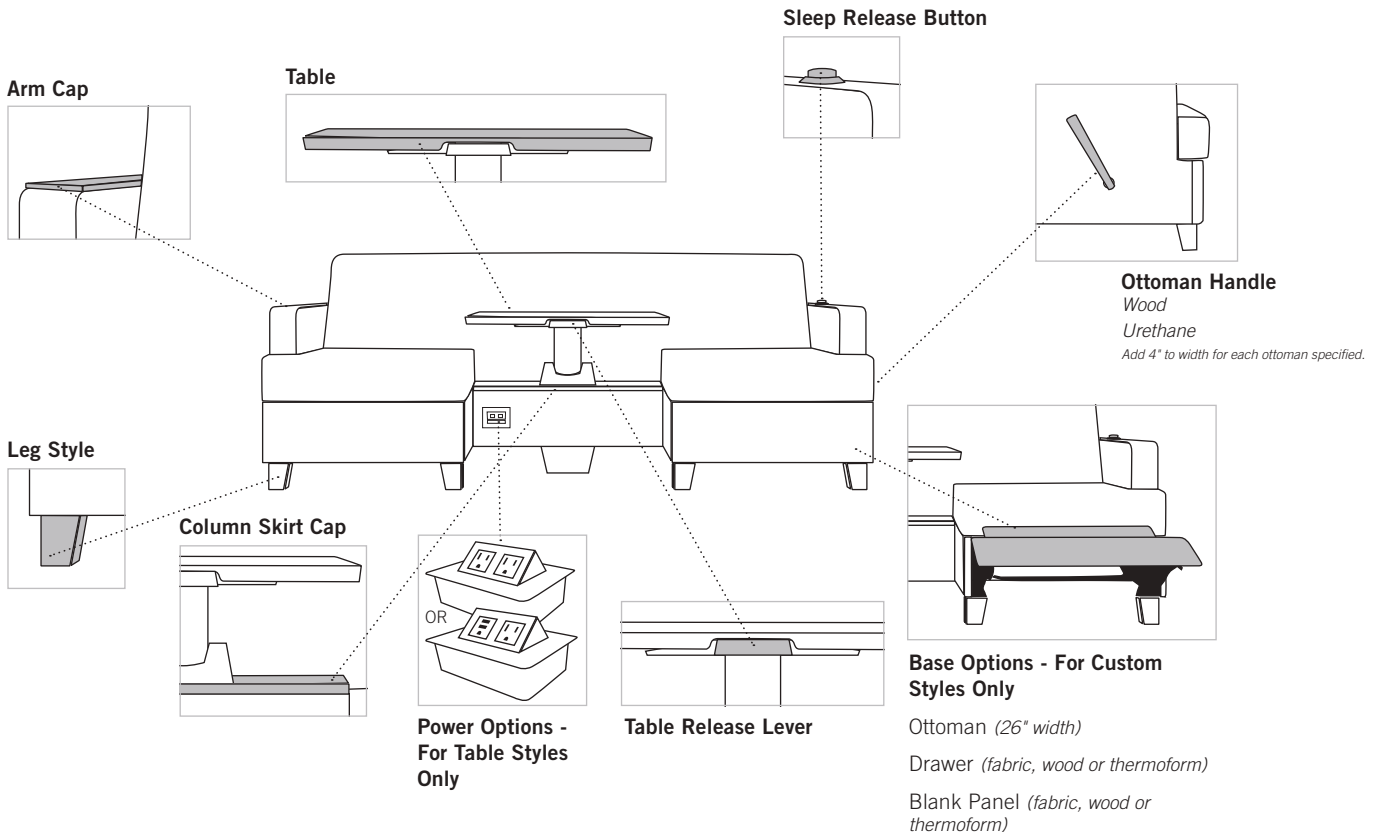

# sleepToo® Classic

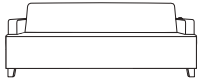

## 62166 SLEEP SOFA, CLASSIC FRONT, 66" SLEEP SURFACE

W: 74" D: 34" H: 33" SW: 66" SD: 21.5" SH: 18.5" AH: 24.5" WT: 172 lb COM: 8.25 yd WT CAP: 750 lb

ZONE	B/COM	C	D	E	F	G	H	I	J	GENERAL INFORMATION
1	9535	9700	9857	10055	10385	10707	11037	11358	11688	MATERIAL: Maple MOIS. BARR: Included
2	9770	9935	10092	10290	10620	10942	11272	11593	11923	
3	10005	10170	10327	10525	10855	11177	11507	11828	12158	
4	10240	10405	10562	10760	11090	11412	11742	12063	12393	

## 62169 SLEEP SOFA, CLASSIC FRONT, 69" SLEEP SURFACE

W: 77" D: 34" H: 33" SW: 69" SD: 21.5" SH: 18.5" AH: 24.5" WT: 178 lb COM: 8.25 yd WT CAP: 750 lb

ZONE	B/COM	C	D	E	F	G	H	I	J	GENERAL INFORMATION
1	9660	9825	9982	10180	10510	10832	11162	11483	11813	MATERIAL: Maple MOIS. BARR: Included
2	9898	10063	10220	10418	10748	11070	11400	11721	12051	
3	10136	10301	10458	10656	10986	11308	11638	11959	12289	
4	10375	10540	10697	10895	11225	11547	11877	12198	12528	

## 62172 SLEEP SOFA, CLASSIC FRONT, 72" SLEEP SURFACE

W: 80" D: 34" H: 33" SW: 72" SD: 21.5" SH: 18.5" AH: 24.5" WT: 184 lb COM: 8.25 yd WT CAP: 750 lb

ZONE	B/COM	C	D	E	F	G	H	I	J	GENERAL INFORMATION
1	9797	9962	10119	10317	10647	10969	11299	11620	11950	MATERIAL: Maple MOIS. BARR: Included
2	10039	10204	10361	10559	10889	11211	11541	11862	12192	
3	10280	10445	10602	10800	11130	11452	11782	12103	12433	
4	10522	10687	10844	11042	11372	11694	12024	12345	12675	

## 62175 SLEEP SOFA, CLASSIC FRONT, 75" SLEEP SURFACE

W: 83" D: 34" H: 33" SW: 75" SD: 21.5" SH: 18.5" AH: 24.5" WT: 190 lb COM: 8.25 yd WT CAP: 750 lb

ZONE	B/COM	C	D	E	F	G	H	I	J	GENERAL INFORMATION
1	9922	10087	10244	10442	10772	11094	11424	11745	12075	MATERIAL: Maple MOIS. BARR: Included
2	10167	10332	10489	10687	11017	11339	11669	11990	12320	
3	10412	10577	10734	10932	11262	11584	11914	12235	12565	
4	10656	10821	10978	11176	11506	11828	12158	12479	12809	

## 62178 SLEEP SOFA, CLASSIC FRONT, 78" SLEEP SURFACE

W: 86" D: 34" H: 33" SW: 78" SD: 21.5" SH: 18.5" AH: 24.5" WT: 196 lb COM: 8.25 yd WT CAP: 750 lb

ZONE	B/COM	C	D	E	F	G	H	I	J	GENERAL INFORMATION
1	10054	10219	10376	10574	10904	11226	11556	11877	12207	MATERIAL: Maple MOIS. BARR: Included
2	10302	10467	10624	10822	11152	11474	11804	12125	12455	
3	10550	10715	10872	11070	11400	11722	12052	12373	12703	
4	10798	10963	11120	11318	11648	11970	12300	12621	12951	

**Specify:**

- Product Number
- Wood Finish
- Urethane Color
- Fabric Vendor, Pattern and Color
- Thermoform Finish
- Metal Finish
- Arm Cap Style
- Leg Style
- Sleep Release Button (Left or Right, Color and Location)
- USB/Power Option

See pages 16 & 17 for material and finish options.

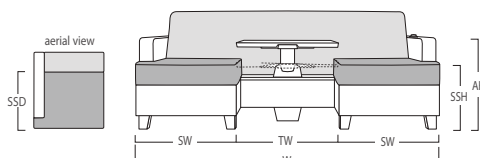

SSH- Sleep surface height 25"  
 SSD- Sleep surface depth 30"  
 SH- Seat height  
 SW- Seat width  
 W- Overall width  
 Add 4" to overall width for each ottoman specified.

# sleepToo® Classic with Table

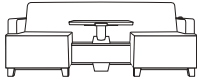

## 62163T SLEEP SOFA, CLASSIC FRONT, WITH TABLE, 63" SLEEP SURFACE

W: 71" D: 34" H: 33" SW: 22.5" SD: 21.5" SH: 18.5" AH: 24.5" WT: 211 lb COM: 7.75 yd WT CAP: 750 lb

ZONE	B/COM	C	D	E	F	G	H	I	J	GENERAL INFORMATION
1	12554	12709	12856	13042	13352	13655	13965	14267	14577	MATERIAL: Maple MOIS. BARR: Included
2	12865	13020	13167	13353	13663	13966	14276	14578	14888	
3	13176	13331	13478	13664	13974	14277	14587	14889	15199	
4	13486	13641	13788	13974	14284	14587	14897	15199	15509	

Power is not available on 63" model.

## 62166T SLEEP SOFA, CLASSIC FRONT, WITH TABLE, 66" SLEEP SURFACE

W: 74" D: 34" H: 33" SW: 22.5" SD: 21.5" SH: 18.5" AH: 24.5" WT: 216 lb COM: 7.75 yd WT CAP: 750 lb

ZONE	B/COM	C	D	E	F	G	H	I	J	GENERAL INFORMATION
1	12963	13118	13265	13451	13761	14064	14374	14676	14986	MATERIAL: Maple MOIS. BARR: Included
2	13284	13439	13586	13772	14082	14385	14695	14997	15307	
3	13605	13760	13907	14093	14403	14706	15016	15318	15628	
4	13926	14081	14228	14414	14724	15027	15337	15639	15949	

## 62169T SLEEP SOFA, CLASSIC FRONT, WITH TABLE, 69" SLEEP SURFACE

W: 77" D: 34" H: 33" SW: 22.5" SD: 21.5" SH: 18.5" AH: 24.5" WT: 221 lb COM: 7.75 yd WT CAP: 750 lb

ZONE	B/COM	C	D	E	F	G	H	I	J	GENERAL INFORMATION
1	13092	13247	13394	13580	13890	14193	14503	14805	15115	MATERIAL: Maple MOIS. BARR: Included
2	13416	13571	13718	13904	14214	14517	14827	15129	15439	
3	13740	13895	14042	14228	14538	14841	15151	15453	15763	
4	14065	14220	14367	14553	14863	15166	15476	15778	16088	

## 62172T SLEEP SOFA, CLASSIC FRONT, WITH TABLE, 72" SLEEP SURFACE

W: 80" D: 34" H: 33" SW: 22.5" SD: 21.5" SH: 18.5" AH: 24.5" WT: 226 lb COM: 7.75 yd WT CAP: 750 lb

ZONE	B/COM	C	D	E	F	G	H	I	J	GENERAL INFORMATION
1	13229	13384	13531	13717	14027	14330	14640	14942	15252	MATERIAL: Maple MOIS. BARR: Included
2	13557	13712	13859	14045	14355	14658	14968	15270	15580	
3	13884	14039	14186	14372	14682	14985	15295	15597	15907	
4	14212	14367	14514	14700	15010	15313	15623	15925	16235	

## 62175T SLEEP SOFA, CLASSIC FRONT, WITH TABLE, 75" SLEEP SURFACE

W: 83" D: 34" H: 33" SW: 22.5" SD: 21.5" SH: 18.5" AH: 24.5" WT: 231 lb COM: 7.75 yd WT CAP: 750 lb

ZONE	B/COM	C	D	E	F	G	H	I	J	GENERAL INFORMATION
1	13361	13516	13663	13849	14159	14462	14772	15074	15384	MATERIAL: Maple MOIS. BARR: Included
2	13692	13847	13994	14180	14490	14793	15103	15405	15715	
3	14023	14178	14325	14511	14821	15124	15434	15736	16046	
4	14354	14509	14656	14842	15152	15455	15765	16067	16377	

### Specify:

- Product Number
- Wood Finish
- Urethane Color
- Fabric Vendor, Pattern and Color
- Thermoform Finish
- Metal Finish
- Arm Cap Style
- Leg Style
- Sleep Release Button (Left or Right, Color and Location)
- USB/Power Option

See pages 16 & 17 for material and finish options.

## 62178T SLEEP SOFA, CLASSIC FRONT, WITH TABLE, 78" SLEEP SURFACE

W: 86" D: 34" H: 33" SW: 22.5" SD: 21.5" SH: 18.5" AH: 24.5" WT: 236 lb COM: 7.75 yd WT CAP: 750 lb

ZONE	B/COM	C	D	E	F	G	H	I	J	GENERAL INFORMATION
1	13500	13655	13802	13988	14298	14601	14911	15213	15523	MATERIAL: Maple MOIS. BARR: Included
2	13834	13989	14136	14322	14632	14935	15245	15547	15857	
3	14169	14324	14471	14657	14967	15270	15580	15882	16192	
4	14503	14658	14805	14991	15301	15604	15914	16216	16526	

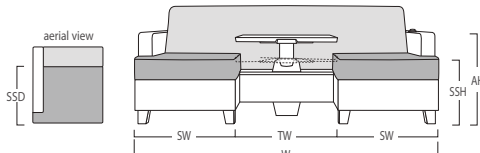

SSH- Sleep surface height 25"  
 SSD- Sleep surface depth 30"  
 SH- Seat height  
 SW- Seat width  
 W- Overall width  
 Add 4" to overall width for each ottoman specified.

# sleepToo® Custom



## 62266 SLEEP SOFA, CUSTOM FRONT, 66" SLEEP SURFACE

W: 74" D: 34" H: 33" SW: 66" SD: 21.5" SH: 18.5" AH: 24.5" WT: 174 lb COM: 9 yd WT CAP: 750 lb

ZONE	B/COM	C	D	E	F	G	H	I	J	GENERAL INFORMATION
1	9559	9739	9910	10126	10486	10837	11197	11548	11908	MATERIAL: Maple MOIS. BARR: Included
2	9794	9974	10145	10361	10721	11072	11432	11783	12143	
3	10030	10210	10381	10597	10957	11308	11668	12019	12379	
4	10265	10445	10616	10832	11192	11543	11903	12254	12614	

## 62269 SLEEP SOFA, CUSTOM FRONT, 69" SLEEP SURFACE

W: 77" D: 34" H: 33" SW: 69" SD: 21.5" SH: 18.5" AH: 24.5" WT: 180 lb COM: 9 yd WT CAP: 750 lb

ZONE	B/COM	C	D	E	F	G	H	I	J	GENERAL INFORMATION
1	9693	9873	10044	10260	10620	10971	11331	11682	12042	MATERIAL: Maple MOIS. BARR: Included
2	9932	10112	10283	10499	10859	11210	11570	11921	12281	
3	10170	10350	10521	10737	11097	11448	11808	12159	12519	
4	10409	10589	10760	10976	11336	11687	12047	12398	12758	

## 62272 SLEEP SOFA, CUSTOM FRONT, 72" SLEEP SURFACE

W: 80" D: 34" H: 33" SW: 72" SD: 21.5" SH: 18.5" AH: 24.5" WT: 186 lb COM: 9 yd WT CAP: 750 lb

ZONE	B/COM	C	D	E	F	G	H	I	J	GENERAL INFORMATION
1	9820	10000	10171	10387	10747	11098	11458	11809	12169	MATERIAL: Maple MOIS. BARR: Included
2	10062	10242	10413	10629	10989	11340	11700	12051	12411	
3	10304	10484	10655	10871	11231	11582	11942	12293	12653	
4	10546	10726	10897	11113	11473	11824	12184	12535	12895	

## 62275 SLEEP SOFA, CUSTOM FRONT, 75" SLEEP SURFACE

W: 83" D: 34" H: 33" SW: 75" SD: 21.5" SH: 18.5" AH: 24.5" WT: 192 lb COM: 9 yd WT CAP: 750 lb

ZONE	B/COM	C	D	E	F	G	H	I	J	GENERAL INFORMATION
1	9950	10130	10301	10517	10877	11228	11588	11939	12299	MATERIAL: Maple MOIS. BARR: Included
2	10195	10375	10546	10762	11122	11473	11833	12184	12544	
3	10440	10620	10791	11007	11367	11718	12078	12429	12789	
4	10685	10865	11036	11252	11612	11963	12323	12674	13034	

## 62278 SLEEP SOFA, CUSTOM FRONT, 78" SLEEP SURFACE

W: 86" D: 34" H: 33" SW: 78" SD: 21.5" SH: 18.5" AH: 24.5" WT: 198 lb COM: 9 yd WT CAP: 750 lb

ZONE	B/COM	C	D	E	F	G	H	I	J	GENERAL INFORMATION
1	10080	10260	10431	10647	11007	11358	11718	12069	12429	MATERIAL: Maple MOIS. BARR: Included
2	10328	10508	10679	10895	11255	11606	11966	12317	12677	
3	10577	10757	10928	11144	11504	11855	12215	12566	12926	
4	10825	11005	11176	11392	11752	12103	12463	12814	13174	

**Specify:**

- Product Number
- Wood Finish
- Urethane Color
- Fabric Vendor, Pattern and Color
- Thermoform Finish
- Metal Finish
- Arm Cap Style
- Leg Style
- Sleep Release Button (Left or Right, Color and Location)
- USB/Power Option

See pages 16 & 17 for material and finish options.

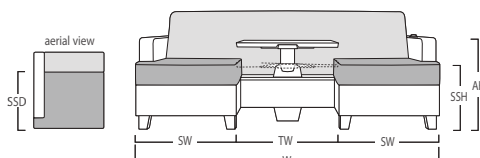

SSH- Sleep surface height 25"  
 SSD- Sleep surface depth 30"  
 SH- Seat height  
 SW- Seat width  
 W- Overall width  
 Add 4" to overall width for each ottoman specified.

# sleepToo® Custom with Table

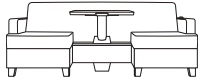

## 62263T SLEEP SOFA, CUSTOM FRONT, WITH TABLE, 63" SLEEP SURFACE

W: 71" D: 34" H: 33" SW: 22.5" SD: 21.5" SH: 18.5" AH: 24.5" WT: 215 lb COM: 8.5 yd WT CAP: 750 lb

ZONE	B/COM	C	D	E	F	G	H	I	J	GENERAL INFORMATION
1	12566	12736	12898	13102	13442	13773	14113	14445	14785	MATERIAL: Maple MOIS. BARR: Included
2	12877	13047	13209	13413	13753	14084	14424	14756	15096	
3	13188	13358	13520	13724	14064	14395	14735	15067	15407	
4	13498	13668	13830	14034	14374	14705	15045	15377	15717	

Power is not available on 63" model.

## 62266T SLEEP SOFA, CUSTOM FRONT, WITH TABLE, 66" SLEEP SURFACE

W: 74" D: 34" H: 33" SW: 22.5" SD: 21.5" SH: 18.5" AH: 24.5" WT: 220 lb COM: 8.5 yd WT CAP: 750 lb

ZONE	B/COM	C	D	E	F	G	H	I	J	GENERAL INFORMATION
1	12979	13149	13311	13515	13855	14186	14526	14858	15198	MATERIAL: Maple MOIS. BARR: Included
2	13300	13470	13632	13836	14176	14507	14847	15179	15519	
3	13621	13791	13953	14157	14497	14828	15168	15500	15840	
4	13942	14112	14274	14478	14818	15149	15489	15821	16161	

## 62269T SLEEP SOFA, CUSTOM FRONT, WITH TABLE, 69" SLEEP SURFACE

W: 77" D: 34" H: 33" SW: 22.5" SD: 21.5" SH: 18.5" AH: 24.5" WT: 225 lb COM: 8.5 yd WT CAP: 750 lb

ZONE	B/COM	C	D	E	F	G	H	I	J	GENERAL INFORMATION
1	13118	13288	13450	13654	13994	14325	14665	14997	15337	MATERIAL: Maple MOIS. BARR: Included
2	13443	13613	13775	13979	14319	14650	14990	15322	15662	
3	13767	13937	14099	14303	14643	14974	15314	15646	15986	
4	14092	14262	14424	14628	14968	15299	15639	15971	16311	

## 62272T SLEEP SOFA, CUSTOM FRONT, WITH TABLE, 72" SLEEP SURFACE

W: 80" D: 34" H: 33" SW: 22.5" SD: 21.5" SH: 18.5" AH: 24.5" WT: 230 lb COM: 8.5 yd WT CAP: 750 lb

ZONE	B/COM	C	D	E	F	G	H	I	J	GENERAL INFORMATION
1	13247	13417	13579	13783	14123	14454	14794	15126	15466	MATERIAL: Maple MOIS. BARR: Included
2	13575	13745	13907	14111	14451	14782	15122	15454	15794	
3	13903	14073	14235	14439	14779	15110	15450	15782	16122	
4	14230	14400	14562	14766	15106	15437	15777	16109	16449	

## 62275T SLEEP SOFA, CUSTOM FRONT, WITH TABLE, 75" SLEEP SURFACE

W: 83" D: 34" H: 33" SW: 22.5" SD: 21.5" SH: 18.5" AH: 24.5" WT: 235 lb COM: 8.5 yd WT CAP: 750 lb

ZONE	B/COM	C	D	E	F	G	H	I	J	GENERAL INFORMATION
1	13383	13553	13715	13919	14259	14590	14930	15262	15602	MATERIAL: Maple MOIS. BARR: Included
2	13714	13884	14046	14250	14590	14921	15261	15593	15933	
3	14045	14215	14377	14581	14921	15252	15592	15924	16264	
4	14377	14547	14709	14913	15253	15584	15924	16256	16596	

### Specify:

- Product Number
- Wood Finish
- Urethane Color
- Fabric Vendor, Pattern and Color
- Thermoform Finish
- Metal Finish
- Arm Cap Style
- Leg Style
- Sleep Release Button (Left or Right, Color and Location)
- USB/Power Option

See pages 16 & 17 for material and finish options.

## 62278T SLEEP SOFA, CUSTOM FRONT, WITH TABLE, 78" SLEEP SURFACE

W: 86" D: 34" H: 33" SW: 22.5" SD: 21.5" SH: 18.5" AH: 24.5" WT: 240 lb COM: 8.5 yd WT CAP: 750 lb

ZONE	B/COM	C	D	E	F	G	H	I	J	GENERAL INFORMATION
1	13519	13689	13851	14055	14395	14726	15066	15398	15738	MATERIAL: Maple MOIS. BARR: Included
2	13854	14024	14186	14390	14730	15061	15401	15733	16073	
3	14188	14358	14520	14724	15064	15395	15735	16067	16407	
4	14523	14693	14855	15059	15399	15730	16070	16402	16742	

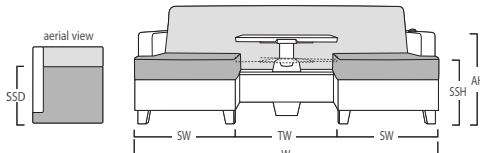

SSH- Sleep surface height 25"  
SSD- Sleep surface depth 30"  
SH- Seat height  
SW- Seat width  
W- Overall width  
Add 4" to overall width for each ottoman specified.

# Soul Sleep Sofa + Mate

## ARM STYLES



Select from Momentum Silica Cumulus or Lotus; Momentum Silica Etch Almond, Flint, Nickel, Wetstone or Wistful; Momentum Silica Leather Almond, Dove, Pewter, Shadow or Eclipse.



Select from Glacier White, Cameo White or Bisque only.

## BACK STYLES (MATE ONLY)



Select from White, Dolphin Grey, Charcoal or Nutmeg.

## ACCESSORIES



Available in black or silver. Usable cord length is 9'. Please get facility approval on power options before ordering. Specify right, left, or both. Power units are UL Listed Tamper Resistant outlets.



Available in silver only. If ordering Soul Mate, specify this option to prevent the mate from hitting the wall when stowed. We recommend this option also be specified if power is selected.



Set of four.

## FINISH OPTIONS

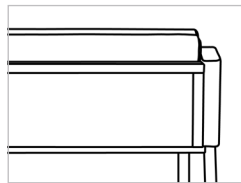

### Back Panel

Wilsonart Silver Oak Ply 8203k-28 only

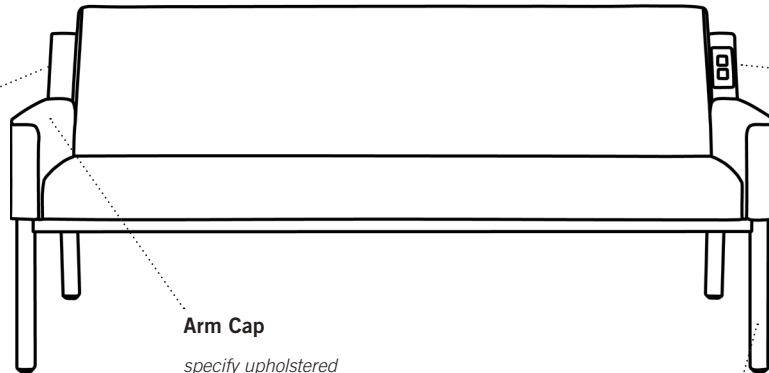

### Arm Cap

specify upholstered or solid surface

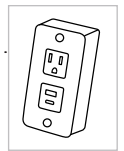

### Power

specify black or silver

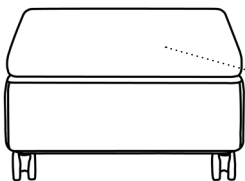

### Resin Overlay

specify white, dolphin grey, charcoal or nutmeg

### Frame/Legs

silver only

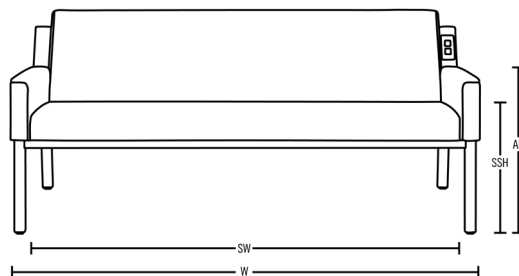
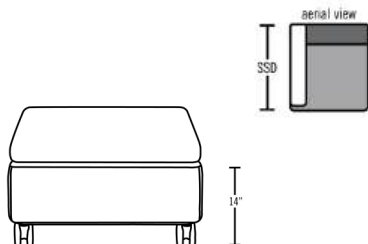

SSH- Sleep surface height 24"  
 SSD- Sleep surface depth 30"  
 SH- Seat height  
 SW- Seat width  
 W- Overall width  
 Mate is 14" from ground when closed (ottoman position).

# Soul Sleep Sofa + Mate



## 17024 SOUL MATE, CONVERTIBLE CUBE, 24" SEAT

W: 24.5" D: 24.5" H: 38.5" SW: 24.25" SD: 19.5" SH: 17.25" AH: - WT: 67 lb COM: 2.5 yd WT CAP: 400 lb

ZONE	B/COM	C	D	E	F	G	H	I	J	GENERAL INFORMATION
1	4244	4294	4342	4402	4502	4599	4699	4797	4897	MATERIAL: Various MOIS. BARR: Included
2	4349	4399	4447	4507	4607	4704	4804	4902	5002	
3	4454	4504	4552	4612	4712	4809	4909	5007	5107	
4	4559	4609	4657	4717	4817	4914	5014	5112	5212	

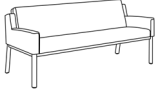

## 17166 SLEEP SOFA, 66" SLEEP SURFACE, 72" WIDE

W: 72" D: 32" H: 34" SW: 66" SD: 20" SH: 19.5" AH: 25.5" WT: 200 lb COM: 5 yd WT CAP: 750 lb

ZONE	B/COM	C	D	E	F	G	H	I	J	GENERAL INFORMATION
1	9853	9953	10048	10168	10368	10563	10763	10958	11158	MATERIAL: Various MOIS. BARR: Included
2	10097	10197	10292	10412	10612	10807	11007	11202	11402	
3	10342	10442	10537	10657	10857	11052	11252	11447	11647	
4	10586	10686	10781	10901	11101	11296	11496	11691	11891	

## 17169 SLEEP SOFA, 69" SLEEP SURFACE, 75" WIDE

W: 75" D: 32" H: 34" SW: 69" SD: 20" SH: 19.5" AH: 25.5" WT: 205 lb COM: 5 yd WT CAP: 750 lb

ZONE	B/COM	C	D	E	F	G	H	I	J	GENERAL INFORMATION
1	9989	10089	10184	10304	10504	10699	10899	11094	11294	MATERIAL: Various MOIS. BARR: Included
2	10237	10337	10432	10552	10752	10947	11147	11342	11542	
3	10484	10584	10679	10799	10999	11194	11394	11589	11789	
4	10732	10832	10927	11047	11247	11442	11642	11837	12037	

## 17172 SLEEP SOFA, 72" SLEEP SURFACE, 78" WIDE

W: 78" D: 32" H: 34" SW: 72" SD: 20" SH: 19.5" AH: 25.5" WT: 210 lb COM: 5.25 yd WT CAP: 750 lb

ZONE	B/COM	C	D	E	F	G	H	I	J	GENERAL INFORMATION
1	10130	10235	10335	10461	10671	10876	11086	11290	11500	MATERIAL: Various MOIS. BARR: Included
2	10381	10486	10586	10712	10922	11127	11337	11541	11751	
3	10632	10737	10837	10963	11173	11378	11588	11792	12002	
4	10883	10988	11088	11214	11424	11629	11839	12043	12253	

## 17175 SLEEP SOFA, 75" SLEEP SURFACE, 81" WIDE

W: 81" D: 32" H: 34" SW: 75" SD: 20" SH: 19.5" AH: 25.5" WT: 215 lb COM: 5.25 yd WT CAP: 750 lb

ZONE	B/COM	C	D	E	F	G	H	I	J	GENERAL INFORMATION
1	10266	10371	10471	10597	10807	11012	11222	11426	11636	MATERIAL: Various MOIS. BARR: Included
2	10521	10626	10726	10852	11062	11267	11477	11681	11891	
3	10775	10880	10980	11106	11316	11521	11731	11935	12145	
4	11030	11135	11235	11361	11571	11776	11986	12190	12400	

## 17178 SLEEP SOFA, 78" SLEEP SURFACE, 84" WIDE

W: 84" D: 32" H: 34" SW: 78" SD: 20" SH: 19.5" AH: 25.5" WT: 220 lb COM: 6 yd WT CAP: 750 lb

ZONE	B/COM	C	D	E	F	G	H	I	J	GENERAL INFORMATION
1	10414	10534	10648	10792	11032	11266	11506	11740	11980	MATERIAL: Various MOIS. BARR: Included
2	10672	10792	10906	11050	11290	11524	11764	11998	12238	
3	10930	11050	11164	11308	11548	11782	12022	12256	12496	
4	11188	11308	11422	11566	11806	12040	12280	12514	12754	

**Specify:**

- Product Number
- Fabric Vendor, Pattern and Color
- Arm Cap Style
- Solid Surface Color
- Power Option
- Backstop Option

See pages 16 & 17 for material and finish options.



## 804020 CHILDREN'S STOOL

### GENERAL INFORMATION

W: 18"      L: 18"      H: 12"      WT: 14 lb

MATERIAL: Metal  
MOIS. BARR: -

Zone	1	2	3	4
	391	401	411	420

Laminate top with smooth metal base. Specify laminate and metal colors when ordering - see Finish by Product chart in Ordering Information section for available selections.



## 803030SQ CHILDREN'S TABLE, SQUARE, 30 X 30 INCH

### GENERAL INFORMATION

W: 30"      L: 30"      H: 21"      WT: 38 lb

MATERIAL: Metal  
MOIS. BARR: -

Zone	1	2	3	4
	980	1004	1029	1054

Laminate top with smooth metal base. Specify laminate and metal colors when ordering - see Finish by Product chart in Ordering Information section for available selections.



## 803232BN CHILDREN'S TABLE, KIDNEY

### GENERAL INFORMATION

W: 32"      L: 32"      H: 21"      WT: 35 lb

MATERIAL: Metal  
MOIS. BARR: -

Zone	1	2	3	4
	980	1004	1029	1054

Laminate top with smooth metal base. Specify laminate and metal colors when ordering - see Finish by Product chart in Ordering Information section for available selections.

### Edge Style Options



#### FLAT PVC EDGE

Available in 7 colors to match metal finishes.

#### Specify:

- Product Number
- Metal Finish
- Edge Finish
- Laminate Vendor, Pattern and Finish

See pages 16 & 17 for material and finish options.

## ARM CAP OPTIONS

---



*Specify black, sable or dove.*



*See ordering information for color options.*



*Specify solid surface color.*

## SEAT OPTIONS

---



*Standard.*

## BACK OPTIONS

---



*Standard.*

## ACCESSORIES

---



*Adds 1.75" between chairs.  
One required between each seat.*



# Trace Waiting and Motion



## 6351122 CHAIR, 22" SEAT, METAL FRAME

W: 26"	D: 24.5"	H: 32.75"	SW: 22"	SD: 18"	SH: 18.5"	AH: 25"	WT: 33 lb	COM: 2 yd	WT CAP: 550 lb	
ZONE	B/COM	C	D	E	F	G	H	I	J	GENERAL INFORMATION
1	2696	2731	2764	2806	2876	2945	3015	3083	3153	MATERIAL: Metal MOIS. BARR: \$21
2	2763	2798	2831	2873	2943	3012	3082	3150	3220	
3	2829	2864	2897	2939	3009	3078	3148	3216	3286	
4	2896	2931	2964	3006	3076	3145	3215	3283	3353	

COM yardage includes standard wood reveal seat and wood outer back only.



## 63511M22 MOTION CHAIR, 22" SEAT, METAL FRAME

W: 26"	D: 24.5"	H: 32.75"	SW: 22"	SD: 18"	SH: 18.5"	AH: 25"	WT: 43 lb	COM: 2 yd	WT CAP: 550 lb	
ZONE	B/COM	C	D	E	F	G	H	I	J	GENERAL INFORMATION
1	3550	3590	3628	3676	3756	3834	3914	3992	4072	MATERIAL: Metal MOIS. BARR: \$24
2	3638	3678	3716	3764	3844	3922	4002	4080	4160	
3	3726	3766	3804	3852	3932	4010	4090	4168	4248	
4	3814	3854	3892	3940	4020	4098	4178	4256	4336	

Only available with fully upholstered seat and outer back (no upcharge).

## 6351130 CHAIR, 30" SEAT, METAL FRAME

W: 34"	D: 24.5"	H: 32.75"	SW: 30"	SD: 18"	SH: 18.5"	AH: 25"	WT: 40 lb	COM: 2.75 yd	WT CAP: 750 lb	
ZONE	B/COM	C	D	E	F	G	H	I	J	GENERAL INFORMATION
1	3037	3077	3115	3163	3243	3321	3401	3479	3559	MATERIAL: Metal MOIS. BARR: \$24
2	3112	3152	3190	3238	3318	3396	3476	3554	3634	
3	3187	3227	3265	3313	3393	3471	3551	3629	3709	
4	3262	3302	3340	3388	3468	3546	3626	3704	3784	

COM yardage includes standard wood reveal seat and wood outer back only.

## 63511M30 MOTION CHAIR, 30" SEAT, METAL FRAME

W: 34"	D: 24.5"	H: 32.75"	SW: 30"	SD: 18"	SH: 18.5"	AH: 25"	WT: 50 lb	COM: 2.75 yd	WT CAP: 750 lb	
ZONE	B/COM	C	D	E	F	G	H	I	J	GENERAL INFORMATION
1	3881	3936	3988	4054	4164	4272	4382	4489	4599	MATERIAL: Metal MOIS. BARR: \$33
2	3977	4032	4084	4150	4260	4368	4478	4585	4695	
3	4073	4128	4180	4246	4356	4464	4574	4681	4791	
4	4169	4224	4276	4342	4452	4560	4670	4777	4887	

Only available with fully upholstered seat and outer back (no upcharge).

## 6351140 CHAIR, 40" SEAT, METAL FRAME

W: 44"	D: 24.5"	H: 32.75"	SW: 40"	SD: 18"	SH: 18.5"	AH: 25"	WT: 50 lb	COM: 2.75 yd	WT CAP: 750 lb	
ZONE	B/COM	C	D	E	F	G	H	I	J	GENERAL INFORMATION
1	3402	3442	3480	3528	3608	3686	3766	3844	3924	MATERIAL: Metal MOIS. BARR: \$24
2	3486	3526	3564	3612	3692	3770	3850	3928	4008	
3	3570	3610	3648	3696	3776	3854	3934	4012	4092	
4	3655	3695	3733	3781	3861	3939	4019	4097	4177	

COM yardage includes standard wood reveal seat and wood outer back only.

**Specify:**

- Product Number
- Arm Cap Style
- Arm Cap Color
- Fabric Vendor, Pattern and Color

See pages 16 & 17 for material and finish options.

# Trace Patient and Motion



## 6357122 PATIENT CHAIR, 22" SEAT, METAL FRAME, HIGH BACK

W: 26" D: 24.5" H: 43" SW: 22" SD: 18" SH: 18.5" AH: 25" WT: 37 lb COM: 2.25 yd WT CAP: 550 lb

ZONE	B/COM	C	D	E	F	G	H	I	J	GENERAL INFORMATION
1	3061	3096	3129	3171	3241	3310	3380	3448	3518	MATERIAL: Metal MOIS. BARR: \$21
2	3137	3172	3205	3247	3317	3386	3456	3524	3594	
3	3213	3248	3281	3323	3393	3462	3532	3600	3670	
4	3288	3323	3356	3398	3468	3537	3607	3675	3745	

COM yardage includes standard wood reveal seat and wood outer back only.

## 6357130 PATIENT CHAIR, 30" SEAT, METAL FRAME, HIGH BACK

W: 34" D: 24.5" H: 43" SW: 30" SD: 18" SH: 18.5" AH: 25" WT: 48 lb COM: 3.25 yd WT CAP: 750 lb

ZONE	B/COM	C	D	E	F	G	H	I	J	GENERAL INFORMATION
1	3816	3861	3904	3958	4048	4136	4226	4313	4403	MATERIAL: Metal MOIS. BARR: \$27
2	3910	3955	3998	4052	4142	4230	4320	4407	4497	
3	4005	4050	4093	4147	4237	4325	4415	4502	4592	
4	4100	4145	4188	4242	4332	4420	4510	4597	4687	

COM yardage includes standard wood reveal seat and wood outer back only.



## 6350100 OTTOMAN, 13" HEIGHT, METAL FRAME

W: 18.5" D: 17" H: 13" SW: - SD: - SH: - AH: - WT: 10 lb COM: 1.5 yd WT CAP: 300 lb

ZONE	B/COM	C	D	E	F	G	H	I	J	GENERAL INFORMATION
1	1355	1385	1414	1450	1510	1568	1628	1687	1747	MATERIAL: Metal MOIS. BARR: \$18
2	1388	1418	1447	1483	1543	1601	1661	1720	1780	
3	1422	1452	1481	1517	1577	1635	1695	1754	1814	
4	1455	1485	1514	1550	1610	1668	1728	1787	1847	

COM yardage includes standard wood reveal seat and wood outer back only.



## 63571M22 MOTION PATIENT CHAIR, 22" SEAT, METAL FRAME

W: 26" D: 24.5" H: 43" SW: 22" SD: 18" SH: 18.5" AH: 25" WT: 47 lb COM: 2.25 yd WT CAP: 550 lb

ZONE	B/COM	C	D	E	F	G	H	I	J	GENERAL INFORMATION
1	3904	3949	3992	4046	4136	4224	4314	4401	4491	MATERIAL: Metal MOIS. BARR: \$27
2	4001	4046	4089	4143	4233	4321	4411	4498	4588	
3	4097	4142	4185	4239	4329	4417	4507	4594	4684	
4	4194	4239	4282	4336	4426	4514	4604	4691	4781	

Only available with fully upholstered seat and outer back (no upcharge).

## 63571M30 MOTION PATIENT CHAIR, 30" SEAT, METAL FRAME

W: 34" D: 24.5" H: 43" SW: 30" SD: 18" SH: 18.5" AH: 25" WT: 58 lb COM: 3.25 yd WT CAP: 750 lb

ZONE	B/COM	C	D	E	F	G	H	I	J	GENERAL INFORMATION
1	4625	4690	4752	4830	4960	5087	5217	5343	5473	MATERIAL: Metal MOIS. BARR: \$39
2	4739	4804	4866	4944	5074	5201	5331	5457	5587	
3	4854	4919	4981	5059	5189	5316	5446	5572	5702	
4	4968	5033	5095	5173	5303	5430	5560	5686	5816	

Only available with fully upholstered seat and outer back (no upcharge).



## 6350100M OTTOMAN, 11" HEIGHT, METAL FRAME, MOTION

W: 18.5" D: 17" H: 11" SW: - SD: - SH: - AH: - WT: 10.5 lb COM: 1.5 yd WT CAP: 300 lb

ZONE	B/COM	C	D	E	F	G	H	I	J	GENERAL INFORMATION
1	1355	1385	1414	1450	1510	1568	1628	1687	1747	MATERIAL: Metal MOIS. BARR: \$18
2	1388	1418	1447	1483	1543	1601	1661	1720	1780	
3	1422	1452	1481	1517	1577	1635	1695	1754	1814	
4	1455	1485	1514	1550	1610	1668	1728	1787	1847	

Designed to nest under motion chairs. Comes standard as fully upholstered.

- Specify:
- Product Number
  - Arm Cap Color
  - Fabric Vendor, Pattern and Color

See pages 16 & 17 for material and finish options.

# Trace Easy Access Chairs



## 63541H22 EASY ACCESS CHAIR, 22" SEAT, METAL FRAME

W: 26" D: 24.25" H: 36" SW: 22" SD: 16" SH: 21.5" AH: 27.75" WT: 36 lb COM: 2 yd WT CAP: 550 lb

ZONE	B/COM	C	D	E	F	G	H	I	J	GENERAL INFORMATION
1	3318	3353	3386	3428	3498	3567	3637	3705	3775	MATERIAL: Metal MOIS. BARR: \$21
2	3400	3435	3468	3510	3580	3649	3719	3787	3857	
3	3482	3517	3550	3592	3662	3731	3801	3869	3939	
4	3565	3600	3633	3675	3745	3814	3884	3952	4022	

COM yardage includes standard wood reveal seat and wood outer back only.

## 63541H30 EASY ACCESS CHAIR, 30" SEAT, METAL FRAME

W: 34" D: 24.25" H: 36" SW: 30" SD: 16" SH: 21.5" AH: 27.75" WT: 43 lb COM: 2.75 yd WT CAP: 750 lb

ZONE	B/COM	C	D	E	F	G	H	I	J	GENERAL INFORMATION
1	3601	3641	3679	3727	3807	3885	3965	4043	4123	MATERIAL: Metal MOIS. BARR: \$24
2	3690	3730	3768	3816	3896	3974	4054	4132	4212	
3	3779	3819	3857	3905	3985	4063	4143	4221	4301	
4	3869	3909	3947	3995	4075	4153	4233	4311	4391	

COM yardage includes standard wood reveal seat and wood outer back only.

**Specify:**

- Product Number
- Arm Cap Color
- Fabric Vendor, Pattern and Color

**See pages 16 & 17 for material and finish options.**

# Trace Tables



## 6300051 METAL END TABLE

W: 20"      D: 20"      H: 21"      WT: 20 lb

### GENERAL INFORMATION

MATERIAL: Metal  
MOIS BARR: -

ZONE	Thermoform	Solid Surface
1	1344	2107
2	1378	2160
3	1411	2212
4	1445	2265

Available with thermoform or solid surface top. Solid surface pricing is for standard colors only. See Ordering Information for additional details.



Thermoform edge



Solid surface edge

**Specify:**

- Product Number
- Thermoform Finish
- Solid Surface Color

**See pages 16 & 17  
for material and finish  
options.**

## SEAT OPTIONS



Specify black or sterling grey.



## BACK OPTIONS



Specify black, light grey or white.



Available on poly and upholstered seat models. Specify wood finish (Maple) and design.

## PLASTIC BACK PANEL COLORS



## WOOD BACK DESIGNS



Specify wood finish (Maple).

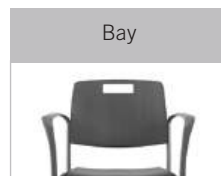

Specify wood finish (Maple).



Specify wood finish (Maple).

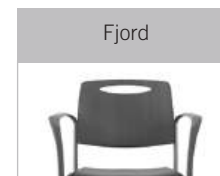

Specify wood finish (Maple).

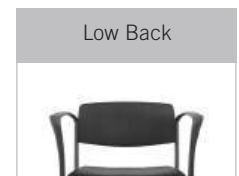

Specify wood finish (Maple). Low back style only available on four-leg models without arms.

## ARM OPTIONS



## FRAME OPTIONS



Specify color. Frame options available in 7 colors to match metal finishes.



Available on four-leg chairs only.

## OPTIONS



# Upland Poly Seat/Plastic Back



## 69UP01 ARM CHAIR, POLY SEAT, PLASTIC BACK

W: 24" D: 22" H: 32.5" SW: 18" SD: - SH: 18" AH: 27" WT: 19 lb COM: - WT CAP: 500 lb

Zone	1	2	3	4	GENERAL INFORMATION
	601	616	631	646	MATERIAL: Metal MOIS. BARR: -

Wood back option available. Chairs stack 8 high with dolly.



## 69UP11 SIDE CHAIR, POLY SEAT, PLASTIC BACK

W: 20.25" D: 22" H: 32.5" SW: 18" SD: - SH: 18" AH: - WT: 15 lb COM: - WT CAP: 500 lb

Zone	1	2	3	4	GENERAL INFORMATION
	601	616	631	646	MATERIAL: Metal MOIS. BARR: -

Wood back option available, including low back. Chairs stack 8 high with dolly.



## 69UP02 ARM CHAIR, POLY SEAT, PLASTIC BACK, CASTERS

W: 24" D: 22" H: 32.5" SW: 18" SD: - SH: 18" AH: 27" WT: 19 lb COM: - WT CAP: 500 lb

Zone	1	2	3	4	GENERAL INFORMATION
	826	847	867	888	MATERIAL: Metal MOIS. BARR: -

Wood back option available. Chairs stack 5 high with dolly.



## 69UP31 ARM CHAIR, POLY SEAT, PLASTIC BACK, SLED BASE

W: 24" D: 22" H: 32.5" SW: 18" SD: - SH: 18" AH: 27" WT: 20 lb COM: - WT CAP: 500 lb

Zone	1	2	3	4	GENERAL INFORMATION
	764	783	802	821	MATERIAL: Metal MOIS. BARR: -

Wood back option available. Sled base models do not stack.



## 69UP41 SIDE CHAIR, POLY SEAT, PLASTIC BACK, SLED BASE

W: 20.25" D: 22" H: 32.5" SW: 18" SD: - SH: 18" AH: - WT: 17 lb COM: - WT CAP: 500 lb

Zone	1	2	3	4	GENERAL INFORMATION
	764	783	802	821	MATERIAL: Metal MOIS. BARR: -

Wood back option available. Sled base models do not stack.

**Specify:**

- Product Number
- Seat Finish
- Back Finish
- Back Panel Finish
- Arm Cap Color
- Metal Finish

See pages 16 & 17 for material and finish options.

# Upland Poly Seat/Plastic Back



## 69UP04 ARM CHAIR, WIDE, POLY SEAT, PLASTIC BACK

W: 27.75" D: 22" H: 32.5" SW: 22" SD: - SH: 18" AH: 27" WT: 22 lb COM: - WT CAP: 500 lb

Zone	1	2	3	4	GENERAL INFORMATION
	845	866	887	908	MATERIAL: Metal MOIS. BARR: -

Wood back option available. Chairs stack 4 high with dolly.



## 69UP14 SIDE CHAIR, WIDE, POLY SEAT, PLASTIC BACK

W: 24" D: 22" H: 32.5" SW: 22" SD: - SH: 18" AH: - WT: 17 lb COM: - WT CAP: 500 lb

Zone	1	2	3	4	GENERAL INFORMATION
	845	866	887	908	MATERIAL: Metal MOIS. BARR: -

Wood back option available, including low back. Chairs stack 4 high with dolly.



## 69UP34 ARM CHAIR, WIDE, POLY SEAT, PLASTIC BACK, SLED BASE

W: 27.75" D: 22" H: 32.5" SW: 22" SD: - SH: 18" AH: 27" WT: 23 lb COM: - WT CAP: 500 lb

Zone	1	2	3	4	GENERAL INFORMATION
	1008	1033	1058	1084	MATERIAL: Metal MOIS. BARR: -

Wood back option available. Sled base models do not stack.



## 69UP44 SIDE CHAIR, WIDE, POLY SEAT, PLASTIC BACK, SLED BASE

W: 24" D: 22" H: 32.5" SW: 22" SD: - SH: 18" AH: - WT: 19 lb COM: - WT CAP: 500 lb

Zone	1	2	3	4	GENERAL INFORMATION
	1008	1033	1058	1084	MATERIAL: Metal MOIS. BARR: -

Wood back option available. Sled base models do not stack.

**Specify:**

- Product Number
- Seat Finish
- Back Finish
- Back Panel Finish
- Arm Cap Color
- Metal Finish

See pages 16 & 17 for material and finish options.

# Upland Poly Seat/Uph Back



## 69UP01UB ARM CHAIR, POLY SEAT, UPH BACK

W: 24" D: 22" H: 32.5" SW: 18" SD: - SH: 18" AH: 27" WT: 19 lb COM: .5 yd WT CAP: 500 lb

ZONE	B/COM	C	D	E	F	G	H	I	J	GENERAL INFORMATION
1	679	689	699	711	731	750	770	790	810	MATERIAL: Metal
2	696	706	716	728	748	767	787	807	827	MOIS. BARR: -
3	713	723	733	745	765	784	804	824	844	
4	729	739	749	761	781	800	820	840	860	

Chairs stack 8 high with dolly.



## 69UP11UB SIDE CHAIR, POLY SEAT, UPH BACK

W: 20.25" D: 22" H: 32.5" SW: 18" SD: - SH: 18" AH: - WT: 15 lb COM: .5 yd WT CAP: 500 lb

ZONE	B/COM	C	D	E	F	G	H	I	J	GENERAL INFORMATION
1	679	689	699	711	731	750	770	790	810	MATERIAL: Metal
2	696	706	716	728	748	767	787	807	827	MOIS. BARR: -
3	713	723	733	745	765	784	804	824	844	
4	729	739	749	761	781	800	820	840	860	

Chairs stack 8 high with dolly.



## 69UP02UB ARM CHAIR, POLY SEAT, UPH BACK, CASTERS

W: 24" D: 22" H: 32.5" SW: 18" SD: - SH: 18" AH: 27" WT: 19 lb COM: .5 yd WT CAP: 500 lb

ZONE	B/COM	C	D	E	F	G	H	I	J	GENERAL INFORMATION
1	904	914	924	936	956	975	995	1015	1035	MATERIAL: Metal
2	926	936	946	958	978	997	1017	1037	1057	MOIS. BARR: -
3	949	959	969	981	1001	1020	1040	1060	1080	
4	971	981	991	1003	1023	1042	1062	1082	1102	

Chairs stack 5 high with dolly.



## 69UP31UB ARM CHAIR, POLY SEAT, UPH BACK, SLED BASE

W: 24" D: 22" H: 32.5" SW: 18" SD: - SH: 18" AH: 27" WT: 18 lb COM: .5 yd WT CAP: 500 lb

ZONE	B/COM	C	D	E	F	G	H	I	J	GENERAL INFORMATION
1	840	850	860	872	892	911	931	951	971	MATERIAL: Metal
2	861	871	881	893	913	932	952	972	992	MOIS. BARR: -
3	882	892	902	914	934	953	973	993	1013	
4	902	912	922	934	954	973	993	1013	1033	

Sled base models do not stack.



## 69UP41UB SIDE CHAIR, POLY SEAT, UPH BACK, SLED BASE

W: 20.25" D: 22" H: 32.5" SW: 18" SD: - SH: 18" AH: - WT: 17 lb COM: .5 yd WT CAP: 500 lb

ZONE	B/COM	C	D	E	F	G	H	I	J	GENERAL INFORMATION
1	840	850	860	872	892	911	931	951	971	MATERIAL: Metal
2	861	871	881	893	913	932	952	972	992	MOIS. BARR: -
3	882	892	902	914	934	953	973	993	1013	
4	902	912	922	934	954	973	993	1013	1033	

Sled base models do not stack.

### Specify:

- Product Number
- Seat Finish
- Back Finish
- Back Panel Finish
- Arm Cap Color
- Fabric Vendor, Pattern and Color
- Metal Finish

See pages 16 & 17 for material and finish options.

# Upland Poly Seat/Uph Back



## 69UP04UB ARM CHAIR, WIDE, POLY SEAT, UPH BACK

W: 27.75" D: 22" H: 32.5" SW: 22" SD: - SH: 18" AH: 27" WT: 18 lb COM: .75 yd WT CAP: 500 lb

ZONE	B/COM	C	D	E	F	G	H	I	J	GENERAL INFORMATION
1	981	996	1010	1028	1058	1088	1118	1147	1177	MATERIAL: Metal
2	1005	1020	1034	1052	1082	1112	1142	1171	1201	MOIS. BARR: -
3	1029	1044	1058	1076	1106	1136	1166	1195	1225	
4	1054	1069	1083	1101	1131	1161	1191	1220	1250	

Chairs stack 4 high with dolly.



## 69UP14UB SIDE CHAIR, WIDE, POLY SEAT, UPH BACK

W: 24" D: 22" H: 32.5" SW: 22" SD: - SH: 18" AH: - WT: 17 lb COM: .75 yd WT CAP: 500 lb

ZONE	B/COM	C	D	E	F	G	H	I	J	GENERAL INFORMATION
1	981	996	1010	1028	1058	1088	1118	1147	1177	MATERIAL: Metal
2	1005	1020	1034	1052	1082	1112	1142	1171	1201	MOIS. BARR: -
3	1029	1044	1058	1076	1106	1136	1166	1195	1225	
4	1054	1069	1083	1101	1131	1161	1191	1220	1250	

Chairs stack 4 high with dolly.



## 69UP34UB ARM CHAIR, WIDE, POLY SEAT, UPH BACK, SLED BASE

W: 27.75" D: 22" H: 32.5" SW: 22" SD: - SH: 18" AH: 27" WT: 23 lb COM: .75 yd WT CAP: 500 lb

ZONE	B/COM	C	D	E	F	G	H	I	J	GENERAL INFORMATION
1	1143	1158	1172	1190	1220	1250	1280	1309	1339	MATERIAL: Metal
2	1171	1186	1200	1218	1248	1278	1308	1337	1367	MOIS. BARR: -
3	1200	1215	1229	1247	1277	1307	1337	1366	1396	
4	1228	1243	1257	1275	1305	1335	1365	1394	1424	

Sled base models do not stack.



## 69UP44UB SIDE CHAIR, WIDE, POLY SEAT, UPH BACK, SLED BASE

W: 24" D: 22" H: 32.5" SW: 22" SD: - SH: 18" AH: - WT: 20 lb COM: .75 yd WT CAP: 500 lb

ZONE	B/COM	C	D	E	F	G	H	I	J	GENERAL INFORMATION
1	1143	1158	1172	1190	1220	1250	1280	1309	1339	MATERIAL: Metal
2	1171	1186	1200	1218	1248	1278	1308	1337	1367	MOIS. BARR: -
3	1200	1215	1229	1247	1277	1307	1337	1366	1396	
4	1228	1243	1257	1275	1305	1335	1365	1394	1424	

Sled base models do not stack.

**Specify:**

- Product Number
- Seat Finish
- Back Finish
- Back Panel Finish
- Arm Cap Color
- Fabric Vendor, Pattern and Color
- Metal Finish

**See pages 16 & 17 for material and finish options.**

# Upland Uph Seat/Plastic Back



## 69UP01US ARM CHAIR, UPH SEAT, PLASTIC BACK

W: 24" D: 22" H: 32.5" SW: 18" SD: - SH: 18" AH: 27" WT: 16 lb COM: .5 yd WT CAP: 500 lb

ZONE	B/COM	C	D	E	F	G	H	I	J	GENERAL INFORMATION
1	699	709	719	731	751	770	790	810	830	MATERIAL: Metal
2	716	726	736	748	768	787	807	827	847	MOIS. BARR: - ADD'L 1"
3	734	744	754	766	786	805	825	845	865	SEAT FOAM: \$26
4	751	761	771	783	803	822	842	862	882	

Wood back option available. Chairs stack 8 high with dolly.



## 69UP11US SIDE CHAIR, UPH SEAT, PLASTIC BACK

W: 20.25" D: 22" H: 32.5" SW: 18" SD: - SH: 18" AH: - WT: 15 lb COM: .5 yd WT CAP: 500 lb

ZONE	B/COM	C	D	E	F	G	H	I	J	GENERAL INFORMATION
1	699	709	719	731	751	770	790	810	830	MATERIAL: Metal
2	716	726	736	748	768	787	807	827	847	MOIS. BARR: - ADD'L 1"
3	734	744	754	766	786	805	825	845	865	SEAT FOAM: \$26
4	751	761	771	783	803	822	842	862	882	

Wood back option available, including low back. Chairs stack 8 high with dolly.



## 69UP02US ARM CHAIR, UPH SEAT, PLASTIC BACK, CASTERS

W: 24" D: 22" H: 32.5" SW: 18" SD: - SH: 18" AH: 27" WT: 17 lb COM: .5 yd WT CAP: 500 lb

ZONE	B/COM	C	D	E	F	G	H	I	J	GENERAL INFORMATION
1	927	937	947	959	979	998	1018	1038	1058	MATERIAL: Metal
2	950	960	970	982	1002	1021	1041	1061	1081	MOIS. BARR: - ADD'L 1"
3	973	983	993	1005	1025	1044	1064	1084	1104	SEAT FOAM: \$26
4	996	1006	1016	1028	1048	1067	1087	1107	1127	

Wood back option available. Chairs stack 5 high with dolly.



## 69UP31US ARM CHAIR, UPH SEAT, PLASTIC BACK, SLED BASE

W: 24" D: 22" H: 32.5" SW: 18" SD: - SH: 18" AH: 27" WT: 20 lb COM: .5 yd WT CAP: 500 lb

ZONE	B/COM	C	D	E	F	G	H	I	J	GENERAL INFORMATION
1	862	872	882	894	914	933	953	973	993	MATERIAL: Metal
2	883	893	903	915	935	954	974	994	1014	MOIS. BARR: - ADD'L 1"
3	905	915	925	937	957	976	996	1016	1036	SEAT FOAM: \$26
4	926	936	946	958	978	997	1017	1037	1057	

Wood back option available. Sled base models do not stack.

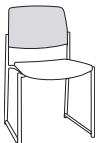

## 69UP41US SIDE CHAIR, UPH SEAT, PLASTIC BACK, SLED BASE

W: 20.25" D: 22" H: 32.5" SW: 18" SD: - SH: 18" AH: - WT: 17 lb COM: .5 yd WT CAP: 500 lb

ZONE	B/COM	C	D	E	F	G	H	I	J	GENERAL INFORMATION
1	862	872	882	894	914	933	953	973	993	MATERIAL: Metal
2	883	893	903	915	935	954	974	994	1014	MOIS. BARR: - ADD'L 1"
3	905	915	925	937	957	976	996	1016	1036	SEAT FOAM: \$26
4	926	936	946	958	978	997	1017	1037	1057	

Wood back option available, including low back. Sled base models do not stack.

### Specify:

- Product Number
- Seat Finish
- Back Finish
- Back Panel Finish
- Arm Cap Color
- Fabric Vendor, Pattern and Color
- Metal Finish

See pages 16 & 17 for material and finish options.

# Upland Uph Seat/Plastic Back



## 69UP04US ARM CHAIR, WIDE, UPH SEAT, PLASTIC BACK

W: 27.75"	D: 22"	H: 32.5"	SW: 22"	SD: -	SH: 18"	AH: 27"	WT: 22 lb	COM: .75 yd	WT CAP: 500 lb	
ZONE	B/COM	C	D	E	F	G	H	I	J	GENERAL INFORMATION
1	899	914	928	946	976	1006	1036	1065	1095	MATERIAL: Metal
2	921	936	950	968	998	1028	1058	1087	1117	MOIS. BARR: -
3	943	958	972	990	1020	1050	1080	1109	1139	ADD'L 1"
4	966	981	995	1013	1043	1073	1103	1132	1162	SEAT FOAM: \$39

Wood back option available. Chairs stack 4 high with dolly.



## 69UP14US SIDE CHAIR, WIDE, UPH SEAT, PLASTIC BACK

W: 24"	D: 22"	H: 32.5"	SW: 22"	SD: -	SH: 18"	AH: -	WT: 17 lb	COM: .75 yd	WT CAP: 500 lb	
ZONE	B/COM	C	D	E	F	G	H	I	J	GENERAL INFORMATION
1	899	914	928	946	976	1006	1036	1065	1095	MATERIAL: Metal
2	921	936	950	968	998	1028	1058	1087	1117	MOIS. BARR: -
3	943	958	972	990	1020	1050	1080	1109	1139	ADD'L 1"
4	966	981	995	1013	1043	1073	1103	1132	1162	SEAT FOAM: \$39

Wood back option available. Chairs stack 4 high with dolly.



## 69UP34US ARM CHAIR, WIDE, UPH SEAT, PLASTIC BACK, SLED BASE

W: 27.75"	D: 22"	H: 32.5"	SW: 22"	SD: -	SH: 18"	AH: 27"	WT: 23 lb	COM: .75 yd	WT CAP: 500 lb	
ZONE	B/COM	C	D	E	F	G	H	I	J	GENERAL INFORMATION
1	1064	1079	1093	1111	1141	1171	1201	1230	1260	MATERIAL: Metal
2	1090	1105	1119	1137	1167	1197	1227	1256	1286	MOIS. BARR: -
3	1117	1132	1146	1164	1194	1224	1254	1283	1313	ADD'L 1"
4	1143	1158	1172	1190	1220	1250	1280	1309	1339	SEAT FOAM: \$39

Wood back option available. Sled base models do not stack.



## 69UP44US SIDE CHAIR, WIDE, UPH SEAT, PLASTIC BACK, SLED BASE

W: 24"	D: 22"	H: 32.5"	SW: 22"	SD: -	SH: 18"	AH: -	WT: 20 lb	COM: .75 yd	WT CAP: 500 lb	
ZONE	B/COM	C	D	E	F	G	H	I	J	GENERAL INFORMATION
1	1064	1079	1093	1111	1141	1171	1201	1230	1260	MATERIAL: Metal
2	1090	1105	1119	1137	1167	1197	1227	1256	1286	MOIS. BARR: -
3	1117	1132	1146	1164	1194	1224	1254	1283	1313	ADD'L 1"
4	1143	1158	1172	1190	1220	1250	1280	1309	1339	SEAT FOAM: \$39

Wood back option available. Sled base models do not stack.

**Specify:**

- Product Number
- Seat Finish
- Back Finish
- Back Panel Finish
- Arm Cap Color
- Fabric Vendor, Pattern and Color
- Metal Finish

**See pages 16 & 17 for material and finish options.**

# Upland Uph Seat/Uph Back



## 69UP01UP ARM CHAIR, UPH SEAT AND BACK

W: 24" D: 22" H: 32.5" SW: 18" SD: - SH: 18" AH: 27" WT: 19 lb COM: 1 yd WT CAP: 500 lb

ZONE	B/COM	C	D	E	F	G	H	I	J	GENERAL INFORMATION
1	776	796	815	839	879	918	958	997	1037	MATERIAL: Metal
2	795	815	834	858	898	937	977	1016	1056	MOIS. BARR: \$5
3	814	834	853	877	917	956	996	1035	1075	ADD'L 1"
4	833	853	872	896	936	975	1015	1054	1094	SEAT FOAM: \$26

Chairs stack 8 high with dolly.



## 69UP11UP SIDE CHAIR, UPH SEAT AND BACK

W: 20.25" D: 22" H: 32.5" SW: 18" SD: - SH: 18" AH: - WT: 15 lb COM: 1 yd WT CAP: 500 lb

ZONE	B/COM	C	D	E	F	G	H	I	J	GENERAL INFORMATION
1	776	796	815	839	879	918	958	997	1037	MATERIAL: Metal
2	795	815	834	858	898	937	977	1016	1056	MOIS. BARR: \$5
3	814	834	853	877	917	956	996	1035	1075	ADD'L 1"
4	833	853	872	896	936	975	1015	1054	1094	SEAT FOAM: \$26

Chairs stack 8 high with dolly.



## 69UP02UP ARM CHAIR, UPH SEAT AND BACK, CASTERS

W: 24" D: 22" H: 32.5" SW: 18" SD: - SH: 18" AH: 27" WT: 19 lb COM: 1 yd WT CAP: 500 lb

ZONE	B/COM	C	D	E	F	G	H	I	J	GENERAL INFORMATION
1	996	1016	1035	1059	1099	1138	1178	1217	1257	MATERIAL: Metal
2	1020	1040	1059	1083	1123	1162	1202	1241	1281	MOIS. BARR: \$5
3	1045	1065	1084	1108	1148	1187	1227	1266	1306	ADD'L 1"
4	1070	1090	1109	1133	1173	1212	1252	1291	1331	SEAT FOAM: \$26

Chairs stack 5 high with dolly.



## 69UP31UP ARM CHAIR, UPH SEAT AND BACK, SLED BASE

W: 24" D: 22" H: 32.5" SW: 18" SD: - SH: 18" AH: 27" WT: 20 lb COM: 1 yd WT CAP: 500 lb

ZONE	B/COM	C	D	E	F	G	H	I	J	GENERAL INFORMATION
1	938	958	977	1001	1041	1080	1120	1159	1199	MATERIAL: Metal
2	961	981	1000	1024	1064	1103	1143	1182	1222	MOIS. BARR: \$5
3	984	1004	1023	1047	1087	1126	1166	1205	1245	ADD'L 1"
4	1007	1027	1046	1070	1110	1149	1189	1228	1268	SEAT FOAM: \$26

Sled base models do not stack.



## 69UP41UP SIDE CHAIR, UPH SEAT AND BACK, SLED BASE

W: 20.25" D: 22" H: 32.5" SW: 18" SD: - SH: 18" AH: - WT: 17 lb COM: 1 yd WT CAP: 500 lb

ZONE	B/COM	C	D	E	F	G	H	I	J	GENERAL INFORMATION
1	938	958	977	1001	1041	1080	1120	1159	1199	MATERIAL: Metal
2	961	981	1000	1024	1064	1103	1143	1182	1222	MOIS. BARR: \$5
3	984	1004	1023	1047	1087	1126	1166	1205	1245	ADD'L 1"
4	1007	1027	1046	1070	1110	1149	1189	1228	1268	SEAT FOAM: \$26

Sled base models do not stack.

### Specify:

- Product Number
- Back Panel Finish
- Arm Cap Color
- Fabric Vendor, Pattern and Color
- Metal Finish

See pages 16 & 17 for material and finish options.

# Upland Uph Seat/Uph Back



## 69UP04UP ARM CHAIR, WIDE, UPH SEAT AND BACK

W: 27.75"	D: 22"	H: 32.5"	SW: 22"	SD: -	SH: 18"	AH: 27"	WT: 22 lb	COM: 1.5 yd	WT CAP: 500 lb	
ZONE	B/COM	C	D	E	F	G	H	I	J	GENERAL INFORMATION
1	1037	1067	1096	1132	1192	1250	1310	1369	1429	MATERIAL: Metal
2	1062	1092	1121	1157	1217	1275	1335	1394	1454	MOIS. BARR: \$5
3	1088	1118	1147	1183	1243	1301	1361	1420	1480	ADD'L 1"
4	1113	1143	1172	1208	1268	1326	1386	1445	1505	SEAT FOAM: \$39

Chairs stack 4 high with dolly.



## 69UP14UP SIDE CHAIR, WIDE, UPH SEAT AND BACK

W: 24"	D: 22"	H: 32.5"	SW: 22"	SD: -	SH: 18"	AH: -	WT: 17 lb	COM: 1.5 yd	WT CAP: 500 lb	
ZONE	B/COM	C	D	E	F	G	H	I	J	GENERAL INFORMATION
1	1037	1067	1096	1132	1192	1250	1310	1369	1429	MATERIAL: Metal
2	1062	1092	1121	1157	1217	1275	1335	1394	1454	MOIS. BARR: \$5
3	1088	1118	1147	1183	1243	1301	1361	1420	1480	ADD'L 1"
4	1113	1143	1172	1208	1268	1326	1386	1445	1505	SEAT FOAM: \$39

Chairs stack 4 high with dolly.



## 69UPCSTM26 ARM CHAIR, BARIATRIC, UPH SEAT AND BACK

W: 32"	D: 22"	H: 32.5"	SW: 26"	SD: -	SH: 18"	AH: 27"	WT: 22 lb	COM: 2 yd	WT CAP: 500 lb	
ZONE	B/COM	C	D	E	F	G	H	I	J	GENERAL INFORMATION
1	1489	1529	1567	1615	1695	1773	1853	1931	2011	MATERIAL: Metal
2	1525	1565	1603	1651	1731	1809	1889	1967	2047	MOIS. BARR: \$5
3	1562	1602	1640	1688	1768	1846	1926	2004	2084	ADD'L 1"
4	1598	1638	1676	1724	1804	1882	1962	2040	2120	SEAT FOAM: \$39

Chairs stack 4 high with dolly.



## 69UP34UP ARM CHAIR, WIDE, UPH SEAT AND BACK, SLED BASE

W: 27.75"	D: 22"	H: 32.5"	SW: 22"	SD: -	SH: 18"	AH: 27"	WT: 22 lb	COM: 1.5 yd	WT CAP: 500 lb	
ZONE	B/COM	C	D	E	F	G	H	I	J	GENERAL INFORMATION
1	1199	1229	1258	1294	1354	1412	1472	1531	1591	MATERIAL: Metal
2	1228	1258	1287	1323	1383	1441	1501	1560	1620	MOIS. BARR: \$5
3	1258	1288	1317	1353	1413	1471	1531	1590	1650	ADD'L 1"
4	1287	1317	1346	1382	1442	1500	1560	1619	1679	SEAT FOAM: \$39

Sled base models do not stack.



## 69UP44UP SIDE CHAIR, WIDE, UPH SEAT AND BACK, SLED BASE

W: 24"	D: 22"	H: 32.5"	SW: 22"	SD: -	SH: 18"	AH: -	WT: 19 lb	COM: 1.5 yd	WT CAP: 500 lb	
ZONE	B/COM	C	D	E	F	G	H	I	J	GENERAL INFORMATION
1	1199	1229	1258	1294	1354	1412	1472	1531	1591	MATERIAL: Metal
2	1228	1258	1287	1323	1383	1441	1501	1560	1620	MOIS. BARR: \$5
3	1258	1288	1317	1353	1413	1471	1531	1590	1650	ADD'L 1"
4	1287	1317	1346	1382	1442	1500	1560	1619	1679	SEAT FOAM: \$39

Sled base models do not stack.

**Specify:**

- Product Number
- Back Panel Finish
- Arm Cap Color
- Fabric Vendor, Pattern and Color
- Metal Finish

**See pages 16 & 17 for material and finish options.**

# Upland Easy Access Poly Seat



## 69UP21E EASY ACCESS ARM CHAIR, POLY SEAT, PLASTIC BACK

W: 24" D: 32" H: 38.5" SW: 18" SD: - SH: 24" AH: 33" WT: 31 lb COM: - WT CAP: 500 lb

Zone	1	2	3	4	GENERAL INFORMATION
	879	901	923	945	MATERIAL: Metal MOIS. BARR: -

Wood back option available. Foot rest offered in black only.



## 69UP24E EASY ACCESS ARM CHAIR, WIDE, POLY SEAT, PLASTIC BACK

W: 27.5" D: 32" H: 38.5" SW: 22" SD: - SH: 24" AH: 33" WT: 34 lb COM: - WT CAP: 500 lb

Zone	1	2	3	4	GENERAL INFORMATION
	1120	1148	1176	1204	MATERIAL: Metal MOIS. BARR: -

Wood back option available. Foot rest offered in black only.



## 69UP21EUB EASY ACCESS ARM CHAIR, POLY SEAT, UPH BACK

W: 24" D: 32" H: 38.5" SW: 18" SD: - SH: 24" AH: 33" WT: 31 lb COM: .5 yd WT CAP: 500 lb

ZONE	B/COM	C	D	E	F	G	H	I	J	GENERAL INFORMATION
1	959	969	979	991	1011	1030	1050	1070	1090	MATERIAL: Metal MOIS. BARR: -
2	983	993	1003	1015	1035	1054	1074	1094	1114	
3	1007	1017	1027	1039	1059	1078	1098	1118	1138	
4	1030	1040	1050	1062	1082	1101	1121	1141	1161	

Foot rest offered in black only.



## 69UP24EUB EASY ACCESS ARM CHAIR, WIDE, POLY SEAT, UPH BACK

W: 27.5" D: 32" H: 38.5" SW: 22" SD: - SH: 24" AH: 33" WT: 34 lb COM: .75 yd WT CAP: 500 lb

ZONE	B/COM	C	D	E	F	G	H	I	J	GENERAL INFORMATION
1	1262	1277	1291	1309	1339	1369	1399	1428	1458	MATERIAL: Metal MOIS. BARR: -
2	1293	1308	1322	1340	1370	1400	1430	1459	1489	
3	1324	1339	1353	1371	1401	1431	1461	1490	1520	
4	1356	1371	1385	1403	1433	1463	1493	1522	1552	

Foot rest offered in black only.

**Specify:**

- Product Number
- Seat Finish
- Back Finish
- Back Panel Finish
- Arm Cap Color
- Metal Finish

See pages 16 & 17 for material and finish options.

# Upland Easy Access Uph Seat

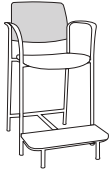

## 69UP21EUS EASY ACCESS ARM CHAIR, UPH SEAT, PLASTIC BACK

W: 24"	D: 32"	H: 38.5"	SW: 18"	SD: -	SH: 24"	AH: 33"	WT: 31 lb	COM: .5 yd	WT CAP: 500 lb	
ZONE	B/COM	C	D	E	F	G	H	I	J	GENERAL INFORMATION
1	976	986	996	1008	1028	1047	1067	1087	1107	MATERIAL: Metal MOIS. BARR: \$5
2	1000	1010	1020	1032	1052	1071	1091	1111	1131	
3	1024	1034	1044	1056	1076	1095	1115	1135	1155	
4	1049	1059	1069	1081	1101	1120	1140	1160	1180	

Wood back option available. Foot rest offered in black only.



## 69UP24EUS EASY ACCESS ARM CHAIR, WIDE, UPH SEAT, PLASTIC BACK

W: 27.75"	D: 32"	H: 38.5"	SW: 22"	SD: -	SH: 24"	AH: 33"	WT: 34 lb	COM: .75 yd	WT CAP: 500 lb	
ZONE	B/COM	C	D	E	F	G	H	I	J	GENERAL INFORMATION
1	1180	1195	1209	1227	1257	1287	1317	1346	1376	MATERIAL: Metal MOIS. BARR: \$5
2	1209	1224	1238	1256	1286	1316	1346	1375	1405	
3	1238	1253	1267	1285	1315	1345	1375	1404	1434	
4	1268	1283	1297	1315	1345	1375	1405	1434	1464	

Wood back option available. Foot rest offered in black only.



## 69UP21EUP EASY ACCESS ARM CHAIR, UPH SEAT AND BACK

W: 24"	D: 32"	H: 38.5"	SW: 18"	SD: -	SH: 24"	AH: 33"	WT: 31 lb	COM: 1 yd	WT CAP: 500 lb	
ZONE	B/COM	C	D	E	F	G	H	I	J	GENERAL INFORMATION
1	1053	1073	1092	1116	1156	1195	1235	1274	1314	MATERIAL: Metal MOIS. BARR: \$5
2	1079	1099	1118	1142	1182	1221	1261	1300	1340	
3	1105	1125	1144	1168	1208	1247	1287	1326	1366	
4	1131	1151	1170	1194	1234	1273	1313	1352	1392	

Foot rest offered in black only.



## 69UP24EUP EASY ACCESS ARM CHAIR, WIDE, UPH SEAT AND BACK

W: 27.75"	D: 32"	H: 38.5"	SW: 22"	SD: -	SH: 24"	AH: 33"	WT: 34 lb	COM: 1.5 yd	WT CAP: 500 lb	
ZONE	B/COM	C	D	E	F	G	H	I	J	GENERAL INFORMATION
1	1316	1346	1375	1411	1471	1529	1589	1648	1708	MATERIAL: Metal MOIS. BARR: \$5
2	1348	1378	1407	1443	1503	1561	1621	1680	1740	
3	1381	1411	1440	1476	1536	1594	1654	1713	1773	
4	1413	1443	1472	1508	1568	1626	1686	1745	1805	

Foot rest offered in black only.

**Specify:**

- Product Number
- Seat Finish
- Back Finish
- Back Panel Finish
- Arm Cap Color
- Fabric Vendor, Pattern and Color
- Metal Finish

**See pages 16 & 17 for material and finish options.**

# Upland Poly Seat/Plastic Back Bar Stools



## 69UP21 BAR STOOL W/ ARMS, POLY SEAT, PLASTIC BACK

W: 24" D: 22" H: 43.5" SW: 18" SD: - SH: 28" AH: 37" WT: 25 lb COM: - WT CAP: 500 lb

Zone	1	2	3	4	GENERAL INFORMATION
	809	829	849	870	MATERIAL: Metal MOIS. BARR: -

Wood back option available.



## 69UP25 BAR STOOL, POLY SEAT, PLASTIC BACK

W: 20.25" D: 22" H: 43.5" SW: 18" SD: - SH: 28" AH: - WT: 24 lb COM: - WT CAP: 500 lb

Zone	1	2	3	4	GENERAL INFORMATION
	809	829	849	870	MATERIAL: Metal MOIS. BARR: -

Wood back option available, including low back.



## 69UP24 BAR STOOL W/ ARMS, WIDE, POLY SEAT, PLASTIC BACK

W: 27.75" D: 22" H: 43.5" SW: 22" SD: - SH: 28" AH: 36" WT: 28 lb COM: - WT CAP: 500 lb

Zone	1	2	3	4	GENERAL INFORMATION
	1050	1076	1102	1129	MATERIAL: Metal MOIS. BARR: -

Wood back option available.



## 69UP26 BAR STOOL, WIDE, POLY SEAT, PLASTIC BACK

W: 24" D: 22" H: 43.5" SW: 22" SD: - SH: 28" AH: - WT: 27 lb COM: - WT CAP: 500 lb

Zone	1	2	3	4	GENERAL INFORMATION
	1050	1076	1102	1129	MATERIAL: Metal MOIS. BARR: -

Wood back option available, including low back.

Specify:

- Product Number
- Seat Finish
- Back Finish
- Back Panel Finish
- Arm Cap Color
- Metal Finish

See pages 16 & 17 for material and finish options.

# Upland Poly Seat/Uph Back Bar Stools



## 69UP21UB BAR STOOL W/ ARMS, POLY SEAT, UPH BACK

W: 24"	D: 22"	H: 43.5"	SW: 18"	SD: -	SH: 28"	AH: 37"	WT: 25 lb	COM: .5 yd	WT CAP: 500 lb	
ZONE	B/COM	C	D	E	F	G	H	I	J	GENERAL INFORMATION
1	886	896	906	918	938	957	977	997	1017	MATERIAL: Metal
2	908	918	928	940	960	979	999	1019	1039	MOIS. BARR: -
3	930	940	950	962	982	1001	1021	1041	1061	
4	952	962	972	984	1004	1023	1043	1063	1083	



## 69UP25UB BAR STOOL, POLY SEAT, UPH BACK

W: 20.25"	D: 22"	H: 43.5"	SW: 18"	SD: -	SH: 28"	AH: -	WT: 24 lb	COM: .5 yd	WT CAP: 500 lb	
ZONE	B/COM	C	D	E	F	G	H	I	J	GENERAL INFORMATION
1	886	896	906	918	938	957	977	997	1017	MATERIAL: Metal
2	908	918	928	940	960	979	999	1019	1039	MOIS. BARR: -
3	930	940	950	962	982	1001	1021	1041	1061	
4	952	962	972	984	1004	1023	1043	1063	1083	



## 69UP24UB BAR STOOL, WIDE W/ ARMS, POLY SEAT, UPH BACK

W: 27.75"	D: 22"	H: 43.5"	SW: 22"	SD: -	SH: 28"	AH: 37"	WT: 28 lb	COM: .75 yd	WT CAP: 500 lb	
ZONE	B/COM	C	D	E	F	G	H	I	J	GENERAL INFORMATION
1	1188	1203	1217	1235	1265	1295	1325	1354	1384	MATERIAL: Metal
2	1217	1232	1246	1264	1294	1324	1354	1383	1413	MOIS. BARR: -
3	1247	1262	1276	1294	1324	1354	1384	1413	1443	
4	1276	1291	1305	1323	1353	1383	1413	1442	1472	



## 69UP26UB BAR STOOL, WIDE, POLY SEAT, UPH BACK

W: 24"	D: 22"	H: 43.5"	SW: 22"	SD: -	SH: 28"	AH: -	WT: 27 lb	COM: .75 yd	WT CAP: 500 lb	
ZONE	B/COM	C	D	E	F	G	H	I	J	GENERAL INFORMATION
1	1188	1203	1217	1235	1265	1295	1325	1354	1384	MATERIAL: Metal
2	1217	1232	1246	1264	1294	1324	1354	1383	1413	MOIS. BARR: -
3	1247	1262	1276	1294	1324	1354	1384	1413	1443	
4	1276	1291	1305	1323	1353	1383	1413	1442	1472	

**Specify:**

- Product Number
- Seat Finish
- Back Panel Finish
- Arm Cap Color
- Fabric Vendor, Pattern and Color
- Metal Finish

**See pages 16 & 17 for material and finish options.**

# Upland Uph Seat/Plastic Back Bar Stools



## 69UP21US BAR STOOL W/ ARMS, UPH SEAT, PLASTIC BACK

W: 24" D: 22" H: 43.5" SW: 18" SD: - SH: 28" AH: 37" WT: 25 lb COM: .5 yd WT CAP: 500 lb

ZONE	B/COM	C	D	E	F	G	H	I	J	GENERAL INFORMATION
1	906	916	926	938	958	977	997	1017	1037	MATERIAL: Metal
2	928	938	948	960	980	999	1019	1039	1059	MOIS. BARR: - ADD'L 1"
3	951	961	971	983	1003	1022	1042	1062	1082	SEAT FOAM: \$26
4	973	983	993	1005	1025	1044	1064	1084	1104	

Wood back option available.



## 69UP25US BAR STOOL, UPH SEAT, PLASTIC BACK

W: 20.25" D: 22" H: 43.5" SW: 18" SD: - SH: 28" AH: - WT: 24 lb COM: .5 yd WT CAP: 500 lb

ZONE	B/COM	C	D	E	F	G	H	I	J	GENERAL INFORMATION
1	906	916	926	938	958	977	997	1017	1037	MATERIAL: Metal
2	928	938	948	960	980	999	1019	1039	1059	MOIS. BARR: - ADD'L 1"
3	951	961	971	983	1003	1022	1042	1062	1082	SEAT FOAM: \$26
4	973	983	993	1005	1025	1044	1064	1084	1104	

Wood back option available, including low back.



## 69UP24US BAR STOOL W/ ARMS, WIDE, UPH SEAT, PLASTIC BACK

W: 27.75" D: 22" H: 43.5" SW: 22" SD: - SH: 28" AH: 37" WT: 28 lb COM: .75 yd WT CAP: 500 lb

ZONE	B/COM	C	D	E	F	G	H	I	J	GENERAL INFORMATION
1	1109	1124	1138	1156	1186	1216	1246	1275	1305	MATERIAL: Metal
2	1136	1151	1165	1183	1213	1243	1273	1302	1332	MOIS. BARR: - ADD'L 1"
3	1164	1179	1193	1211	1241	1271	1301	1330	1360	SEAT FOAM: \$39
4	1191	1206	1220	1238	1268	1298	1328	1357	1387	

Wood back option available.



## 69UP26US BAR STOOL, WIDE, UPH SEAT, PLASTIC BACK

W: 24" D: 22" H: 43.5" SW: 22" SD: - SH: 28" AH: - WT: 27 lb COM: .75 yd WT CAP: 500 lb

ZONE	B/COM	C	D	E	F	G	H	I	J	GENERAL INFORMATION
1	1109	1124	1138	1156	1186	1216	1246	1275	1305	MATERIAL: Metal
2	1136	1151	1165	1183	1213	1243	1273	1302	1332	MOIS. BARR: - ADD'L 1"
3	1164	1179	1193	1211	1241	1271	1301	1330	1360	SEAT FOAM: \$39
4	1191	1206	1220	1238	1268	1298	1328	1357	1387	

Wood back option available, including low back.

**Specify:**

- Product Number
- Back Finish
- Back Panel Finish
- Arm Cap Color
- Fabric Vendor, Pattern and Color
- Metal Finish

**See pages 16 & 17 for material and finish options.**

# Upland Uph Seat/Uph Back Bar Stools



## 69UP21UP BAR STOOL W/ ARMS, UPH SEAT AND BACK

W: 24"	D: 22"	H: 43.5"	SW: 18"	SD: -	SH: 28"	AH: 37"	WT: 25 lb	COM: 1 yd	WT CAP: 500 lb	
ZONE	B/COM	C	D	E	F	G	H	I	J	GENERAL INFORMATION
1	982	1002	1021	1045	1085	1124	1164	1203	1243	MATERIAL: Metal
2	1006	1026	1045	1069	1109	1148	1188	1227	1267	MOIS. BARR: \$5
3	1030	1050	1069	1093	1133	1172	1212	1251	1291	ADD'L 1"
4	1054	1074	1093	1117	1157	1196	1236	1275	1315	SEAT FOAM: \$26

Wood back option available.



## 69UP25UP BAR STOOL, UPH SEAT AND BACK

W: 20.25"	D: 22"	H: 43.5"	SW: 18"	SD: -	SH: 28"	AH: -	WT: 24 lb	COM: 1 yd	WT CAP: 500 lb	
ZONE	B/COM	C	D	E	F	G	H	I	J	GENERAL INFORMATION
1	982	1002	1021	1045	1085	1124	1164	1203	1243	MATERIAL: Metal
2	1006	1026	1045	1069	1109	1148	1188	1227	1267	MOIS. BARR: \$5
3	1030	1050	1069	1093	1133	1172	1212	1251	1291	ADD'L 1"
4	1054	1074	1093	1117	1157	1196	1236	1275	1315	SEAT FOAM: \$26

Wood back option available.



## 69UP24UP BAR STOOL W/ ARMS, WIDE, UPH SEAT AND BACK

W: 27.75"	D: 22"	H: 43.5"	SW: 22"	SD: -	SH: 28"	AH: 37"	WT: 28 lb	COM: 1.5 yd	WT CAP: 500 lb	
ZONE	B/COM	C	D	E	F	G	H	I	J	GENERAL INFORMATION
1	1244	1274	1303	1339	1399	1457	1517	1576	1636	MATERIAL: Metal
2	1274	1304	1333	1369	1429	1487	1547	1606	1666	MOIS. BARR: \$5
3	1305	1335	1364	1400	1460	1518	1578	1637	1697	ADD'L 1"
4	1336	1366	1395	1431	1491	1549	1609	1668	1728	SEAT FOAM: \$39

Wood back option available.



## 69UP26UP BAR STOOL, WIDE, UPH SEAT AND BACK

W: 24"	D: 22"	H: 43.5"	SW: 22"	SD: -	SH: 28"	AH: -	WT: 27 lb	COM: 1.5 yd	WT CAP: 500 lb	
ZONE	B/COM	C	D	E	F	G	H	I	J	GENERAL INFORMATION
1	1244	1274	1303	1339	1399	1457	1517	1576	1636	MATERIAL: Metal
2	1274	1304	1333	1369	1429	1487	1547	1606	1666	MOIS. BARR: \$5
3	1305	1335	1364	1400	1460	1518	1578	1637	1697	ADD'L 1"
4	1336	1366	1395	1431	1491	1549	1609	1668	1728	SEAT FOAM: \$39

Wood back option available.

### Accessories



#### 69UP99 DOLLY, STANDARD

W: 22.5"	D: 34"	H: 37"	WT: 20 lb
Zone 1	Zone 2	Zone 3	Zone 4
\$580	\$594	\$609	\$624

#### 69UP99M DOLLY, WIDE

W: 32.5"	D: 34"	H: 37"	WT: 25 lb
Zone 1	Zone 2	Zone 3	Zone 4
\$831	\$852	\$873	\$893



#### 69UP14CON CONNECTING BAR - GANGING

\$136  
Add one bar for each chair. Connecting bar will match frame color.

#### Specify:

- Product Number
- Back Panel Finish
- Arm Cap Color
- Fabric Vendor, Pattern and Color
- Metal Finish
- Edge Style and Finish
- Laminate Vendor, Pattern and Finish

See pages 16 & 17 for material and finish options.

# Upland Tables



## 69UP14RC CORNER TABLE, MODULAR

W: 25" D: 25" H: 17.5" WT: 13 lb

### GENERAL INFORMATION

MATERIAL: Laminate  
MOIS. BARR: -

	All Zones
	556

Specify edge style and finish when ordering.



## 69UP14ST SPACER TABLE, MODULAR

W: 17" D: 17" H: 17.5" WT: 8 lb

### GENERAL INFORMATION

MATERIAL: Laminate  
MOIS. BARR: -

	All Zones
	383

Specify edge style and finish when ordering.



## 69UP14MT MINI SPACER TABLE, MODULAR

W: 4.5" D: 14.5" H: 17.5" WT: 3 lb

### GENERAL INFORMATION

MATERIAL: Laminate  
MOIS. BARR: -

	All Zones
	226

Specify edge style and finish when ordering.



## 69UP14ET END TABLE, MODULAR

W: 17" D: 17" H: 17.5" WT: 13 lb

### GENERAL INFORMATION

MATERIAL: Laminate  
MOIS. BARR: -

	All Zones
	396

Specify edge style and finish when ordering.

### Edge Style Options



#### FLAT PVC EDGE

Available in 7 colors to match metal finishes.



#### SELF EDGE

Matches top laminate.



#### 2MM BIO EDGE

Available in 7 colors to match metal finishes.



#### 2MM PVC WOOD GRAIN EDGE

Available in 9 wood grain colors to match standard laminates.

#### Specify:

- Product Number
- Metal Finish
- Edge Style and Finish
- Laminate Vendor, Pattern and Finish

See pages 16 & 17 for material and finish options.

# Versant Glider



## 54151WG20 GLIDER, 20" SEAT, UPH ARM, WOOD CAP, SHORT SKIRT

W: 27.5" D: 30" H: 42" SW: 20" SD: 19.5" SH: 18.5" AH: 24.75" WT: 63 lb COM: 4 yd WT CAP: 350 lb

ZONE	B/COM	C	D	E	F	G	H	I	J	GENERAL INFORMATION
1	4693	4773	4849	4945	5105	5261	5421	5577	5737	MATERIAL: Maple MOIS. BARR: Included
2	4809	4889	4965	5061	5221	5377	5537	5693	5853	
3	4924	5004	5080	5176	5336	5492	5652	5808	5968	
4	5040	5120	5196	5292	5452	5608	5768	5924	6084	

## 54151WG22 GLIDER, 22" SEAT, UPH ARM, WOOD CAP, SHORT SKIRT

W: 29.5" D: 30" H: 42" SW: 22" SD: 19.5" SH: 18.5" AH: 24.75" WT: 66 lb COM: 4 yd WT CAP: 350 lb

ZONE	B/COM	C	D	E	F	G	H	I	J	GENERAL INFORMATION
1	4887	4967	5043	5139	5299	5455	5615	5771	5931	MATERIAL: Maple MOIS. BARR: Included
2	5008	5088	5164	5260	5420	5576	5736	5892	6052	
3	5128	5208	5284	5380	5540	5696	5856	6012	6172	
4	5249	5329	5405	5501	5661	5817	5977	6133	6293	

## 54151WG24 GLIDER, 24" SEAT, UPH ARM, WOOD CAP, SHORT SKIRT

W: 31.5" D: 30" H: 42" SW: 24" SD: 19.5" SH: 18.5" AH: 24.75" WT: 69 lb COM: 4.25 yd WT CAP: 350 lb

ZONE	B/COM	C	D	E	F	G	H	I	J	GENERAL INFORMATION
1	5097	5182	5263	5365	5535	5701	5871	6036	6206	MATERIAL: Maple MOIS. BARR: Included
2	5223	5308	5389	5491	5661	5827	5997	6162	6332	
3	5348	5433	5514	5616	5786	5952	6122	6287	6457	
4	5474	5559	5640	5742	5912	6078	6248	6413	6583	



## 54151UG20 GLIDER, 20" SEAT, UPH ARM, URETHANE CAP, SHORT SKIRT

W: 27.5" D: 30" H: 42" SW: 20" SD: 19.5" SH: 18.5" AH: 24.75" WT: 63 lb COM: 4 yd WT CAP: 350 lb

ZONE	B/COM	C	D	E	F	G	H	I	J	GENERAL INFORMATION
1	4693	4773	4849	4945	5105	5261	5421	5577	5737	MATERIAL: - MOIS. BARR: Included
2	4809	4889	4965	5061	5221	5377	5537	5693	5853	
3	4924	5004	5080	5176	5336	5492	5652	5808	5968	
4	5040	5120	5196	5292	5452	5608	5768	5924	6084	

Urethane arm caps are available in black, sable or dove.

## 54151UG22 GLIDER, 22" SEAT, UPH ARM, URETHANE CAP, SHORT SKIRT

W: 29.5" D: 30" H: 42" SW: 22" SD: 19.5" SH: 18.5" AH: 24.75" WT: 66 lb COM: 4 yd WT CAP: 350 lb

ZONE	B/COM	C	D	E	F	G	H	I	J	GENERAL INFORMATION
1	4887	4967	5043	5139	5299	5455	5615	5771	5931	MATERIAL: - MOIS. BARR: Included
2	5008	5088	5164	5260	5420	5576	5736	5892	6052	
3	5128	5208	5284	5380	5540	5696	5856	6012	6172	
4	5249	5329	5405	5501	5661	5817	5977	6133	6293	

Urethane arm caps are available in black, sable or dove.

## 54151UG24 GLIDER, 24" SEAT, UPH ARM, URETHANE CAP, SHORT SKIRT

W: 31.5" D: 30" H: 42" SW: 24" SD: 19.5" SH: 18.5" AH: 24.75" WT: 69 lb COM: 4.25 yd WT CAP: 350 lb

ZONE	B/COM	C	D	E	F	G	H	I	J	GENERAL INFORMATION
1	5097	5182	5263	5365	5535	5701	5871	6036	6206	MATERIAL: - MOIS. BARR: Included
2	5223	5308	5389	5491	5661	5827	5997	6162	6332	
3	5348	5433	5514	5616	5786	5952	6122	6287	6457	
4	5474	5559	5640	5742	5912	6078	6248	6413	6583	

Urethane arm caps are available in black, sable or dove.

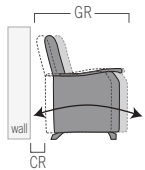

GR- Glider range from forward point to rear point is 41"

CR- Clearance required when placed against a wall is 7"

**Specify:**

- Product Number
- Wood Finish
- Urethane Cap Color
- Fabric Vendor, Pattern and Color

See pages 16 & 17 for material and finish options.

# Versant Glider



## 54151WLG20 GLIDER, 20" SEAT, UPH ARM, WOOD CAP, SHORT SKIRT, LOCKING MECHANISM

W: 27.5" D: 30" H: 42" SW: 20" SD: 19.5" SH: 18.5" AH: 24.75" WT: 65 lb COM: 4 yd WT CAP: 350 lb

ZONE	B/COM	C	D	E	F	G	H	I	J	GENERAL INFORMATION
1	4992	5072	5148	5244	5404	5560	5720	5876	6036	MATERIAL: Maple
2	5115	5195	5271	5367	5527	5683	5843	5999	6159	MOIS. BARR: Included
3	5238	5318	5394	5490	5650	5806	5966	6122	6282	
4	5362	5442	5518	5614	5774	5930	6090	6246	6406	

## 54151WLG22 GLIDER, 22" SEAT, UPH ARM, WOOD CAP, SHORT SKIRT, LOCKING MECHANISM

W: 29.5" D: 30" H: 42" SW: 22" SD: 19.5" SH: 18.5" AH: 24.75" WT: 68 lb COM: 4 yd WT CAP: 350 lb

ZONE	B/COM	C	D	E	F	G	H	I	J	GENERAL INFORMATION
1	5200	5280	5356	5452	5612	5768	5928	6084	6244	MATERIAL: Maple
2	5328	5408	5484	5580	5740	5896	6056	6212	6372	MOIS. BARR: Included
3	5457	5537	5613	5709	5869	6025	6185	6341	6501	
4	5585	5665	5741	5837	5997	6153	6313	6469	6629	

## 54151WLG24 GLIDER, 24" SEAT, UPH ARM, WOOD CAP, SHORT SKIRT, LOCKING MECHANISM

W: 31.5" D: 30" H: 42" SW: 24" SD: 19.5" SH: 18.5" AH: 24.75" WT: 71 lb COM: 4.25 yd WT CAP: 350 lb

ZONE	B/COM	C	D	E	F	G	H	I	J	GENERAL INFORMATION
1	5423	5508	5589	5691	5861	6027	6197	6362	6532	MATERIAL: Maple
2	5557	5642	5723	5825	5995	6161	6331	6496	6666	MOIS. BARR: Included
3	5691	5776	5857	5959	6129	6295	6465	6630	6800	
4	5825	5910	5991	6093	6263	6429	6599	6764	6934	



## 54151ULG20 GLIDER, 20" SEAT, UPH ARM, URETHANE CAP, SHORT SKIRT, LOCKING MECHANISM

W: 27.5" D: 30" H: 42" SW: 20" SD: 19.5" SH: 18.5" AH: 24.75" WT: 65 lb COM: 4 yd WT CAP: 350 lb

ZONE	B/COM	C	D	E	F	G	H	I	J	GENERAL INFORMATION
1	4992	5072	5148	5244	5404	5560	5720	5876	6036	MATERIAL: -
2	5115	5195	5271	5367	5527	5683	5843	5999	6159	MOIS. BARR: Included
3	5238	5318	5394	5490	5650	5806	5966	6122	6282	
4	5362	5442	5518	5614	5774	5930	6090	6246	6406	

Urethane arm caps are available in black, sable or dove.

## 54151ULG22 GLIDER, 22" SEAT, UPH ARM, URETHANE CAP, SHORT SKIRT, LOCKING MECHANISM

W: 29.5" D: 30" H: 42" SW: 22" SD: 19.5" SH: 18.5" AH: 24.75" WT: 68 lb COM: 4 yd WT CAP: 350 lb

ZONE	B/COM	C	D	E	F	G	H	I	J	GENERAL INFORMATION
1	5200	5280	5356	5452	5612	5768	5928	6084	6244	MATERIAL: -
2	5328	5408	5484	5580	5740	5896	6056	6212	6372	MOIS. BARR: Included
3	5457	5537	5613	5709	5869	6025	6185	6341	6501	
4	5585	5665	5741	5837	5997	6153	6313	6469	6629	

Urethane arm caps are available in black, sable or dove.

## 54151ULG24 GLIDER, 24" SEAT, UPH ARM, URETHANE CAP, SHORT SKIRT, LOCKING MECHANISM

W: 31.5" D: 30" H: 42" SW: 24" SD: 19.5" SH: 18.5" AH: 24.75" WT: 71 lb COM: 4.25 yd WT CAP: 350 lb

ZONE	B/COM	C	D	E	F	G	H	I	J	GENERAL INFORMATION
1	5423	5508	5589	5691	5861	6027	6197	6362	6532	MATERIAL: -
2	5557	5642	5723	5825	5995	6161	6331	6496	6666	MOIS. BARR: Included
3	5691	5776	5857	5959	6129	6295	6465	6630	6800	
4	5825	5910	5991	6093	6263	6429	6599	6764	6934	

Urethane arm caps are available in black, sable or dove.

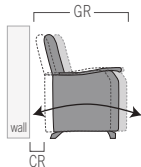

GR- Glider range from forward point to rear point is 41"

CR- Clearance required when placed against a wall is 7"

**Specify:**

- Product Number
- Wood Finish
- Urethane Cap Color
- Fabric Vendor, Pattern and Color

See pages 16 & 17 for material and finish options.

# Versant Glider

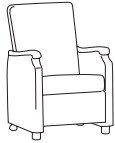

## 54251WG20 GLIDER, 20" SEAT, UPH ARM, WOOD CAP, LONG SKIRT

W: 27.5" D: 30" H: 42" SW: 20" SD: 19.5" SH: 18.5" AH: 24.75" WT: 63 lb COM: 4 yd WT CAP: 350 lb

ZONE	B/COM	C	D	E	F	G	H	I	J	GENERAL INFORMATION
1	4763	4843	4919	5015	5175	5331	5491	5647	5807	MATERIAL: Maple MOIS. BARR: Included
2	4880	4960	5036	5132	5292	5448	5608	5764	5924	
3	4998	5078	5154	5250	5410	5566	5726	5882	6042	
4	5115	5195	5271	5367	5527	5683	5843	5999	6159	

## 54251WG22 GLIDER, 22" SEAT, UPH ARM, WOOD CAP, LONG SKIRT

W: 29.5" D: 30" H: 42" SW: 22" SD: 19.5" SH: 18.5" AH: 24.75" WT: 66 lb COM: 4.25 yd WT CAP: 350 lb

ZONE	B/COM	C	D	E	F	G	H	I	J	GENERAL INFORMATION
1	4964	5049	5130	5232	5402	5568	5738	5903	6073	MATERIAL: Maple MOIS. BARR: Included
2	5086	5171	5252	5354	5524	5690	5860	6025	6195	
3	5209	5294	5375	5477	5647	5813	5983	6148	6318	
4	5331	5416	5497	5599	5769	5935	6105	6270	6440	

## 54251WG24 GLIDER, 24" SEAT, UPH ARM, WOOD CAP, LONG SKIRT

W: 31.5" D: 30" H: 42" SW: 24" SD: 19.5" SH: 18.5" AH: 24.75" WT: 69 lb COM: 4.5 yd WT CAP: 350 lb

ZONE	B/COM	C	D	E	F	G	H	I	J	GENERAL INFORMATION
1	5176	5266	5352	5460	5640	5815	5995	6171	6351	MATERIAL: Maple MOIS. BARR: Included
2	5304	5394	5480	5588	5768	5943	6123	6299	6479	
3	5431	5521	5607	5715	5895	6070	6250	6426	6606	
4	5559	5649	5735	5843	6023	6198	6378	6554	6734	



## 54251UG20 GLIDER, 20" SEAT, UPH ARM, URETHANE CAP, LONG SKIRT

W: 27.5" D: 30" H: 42" SW: 20" SD: 19.5" SH: 18.5" AH: 24.75" WT: 63 lb COM: 4 yd WT CAP: 350 lb

ZONE	B/COM	C	D	E	F	G	H	I	J	GENERAL INFORMATION
1	4763	4843	4919	5015	5175	5331	5491	5647	5807	MATERIAL: - MOIS. BARR: Included
2	4880	4960	5036	5132	5292	5448	5608	5764	5924	
3	4998	5078	5154	5250	5410	5566	5726	5882	6042	
4	5115	5195	5271	5367	5527	5683	5843	5999	6159	

Urethane arm caps are available in black, sable or dove.

## 54251UG22 GLIDER, 22" SEAT, UPH ARM, URETHANE CAP, LONG SKIRT

W: 29.5" D: 30" H: 42" SW: 22" SD: 19.5" SH: 18.5" AH: 24.75" WT: 66 lb COM: 4.25 yd WT CAP: 350 lb

ZONE	B/COM	C	D	E	F	G	H	I	J	GENERAL INFORMATION
1	4964	5049	5130	5232	5402	5568	5738	5903	6073	MATERIAL: - MOIS. BARR: Included
2	5086	5171	5252	5354	5524	5690	5860	6025	6195	
3	5209	5294	5375	5477	5647	5813	5983	6148	6318	
4	5331	5416	5497	5599	5769	5935	6105	6270	6440	

Urethane arm caps are available in black, sable or dove.

## 54251UG24 GLIDER, 24" SEAT, UPH ARM, URETHANE CAP, LONG SKIRT

W: 31.5" D: 30" H: 42" SW: 24" SD: 19.5" SH: 18.5" AH: 24.75" WT: 69 lb COM: 4.5 yd WT CAP: 350 lb

ZONE	B/COM	C	D	E	F	G	H	I	J	GENERAL INFORMATION
1	5176	5266	5352	5460	5640	5815	5995	6171	6351	MATERIAL: - MOIS. BARR: Included
2	5304	5394	5480	5588	5768	5943	6123	6299	6479	
3	5431	5521	5607	5715	5895	6070	6250	6426	6606	
4	5559	5649	5735	5843	6023	6198	6378	6554	6734	

Urethane arm caps are available in black, sable or dove.

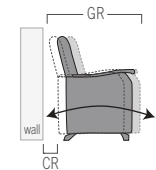

GR- Glider range from forward point to rear point is 41"

CR- Clearance required when placed against a wall is 7"

**Specify:**

- Product Number
- Wood Finish
- Urethane Cap Color
- Fabric Vendor, Pattern and Color

See pages 16 & 17 for material and finish options.

# Versant Glider

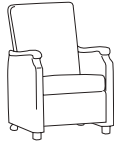

## 54251WLG20 GLIDER, 20" SEAT, UPH ARM, WOOD CAP, LONG SKIRT, LOCKING MECHANISM

W: 27.5" D: 30" H: 42" SW: 20" SD: 19.5" SH: 18.5" AH: 24.75" WT: 65 lb COM: 4 yd WT CAP: 350 lb

ZONE	B/COM	C	D	E	F	G	H	I	J	GENERAL INFORMATION
1	5064	5144	5220	5316	5476	5632	5792	5948	6108	MATERIAL: Maple
2	5189	5269	5345	5441	5601	5757	5917	6073	6233	MOIS. BARR: Included
3	5314	5394	5470	5566	5726	5882	6042	6198	6358	
4	5439	5519	5595	5691	5851	6007	6167	6323	6483	

## 54251WLG22 GLIDER, 22" SEAT, UPH ARM, WOOD CAP, LONG SKIRT, LOCKING MECHANISM

W: 29.5" D: 30" H: 42" SW: 22" SD: 19.5" SH: 18.5" AH: 24.75" WT: 68 lb COM: 4.25 yd WT CAP: 350 lb

ZONE	B/COM	C	D	E	F	G	H	I	J	GENERAL INFORMATION
1	5278	5363	5444	5546	5716	5882	6052	6217	6387	MATERIAL: Maple
2	5408	5493	5574	5676	5846	6012	6182	6347	6517	MOIS. BARR: Included
3	5538	5623	5704	5806	5976	6142	6312	6477	6647	
4	5669	5754	5835	5937	6107	6273	6443	6608	6778	

## 54251WLG24 GLIDER, 24" SEAT, UPH ARM, WOOD CAP, LONG SKIRT, LOCKING MECHANISM

W: 31.5" D: 30" H: 42" SW: 24" SD: 19.5" SH: 18.5" AH: 24.75" WT: 71 lb COM: 4.5 yd WT CAP: 350 lb

ZONE	B/COM	C	D	E	F	G	H	I	J	GENERAL INFORMATION
1	5505	5595	5681	5789	5969	6144	6324	6500	6680	MATERIAL: Maple
2	5641	5731	5817	5925	6105	6280	6460	6636	6816	MOIS. BARR: Included
3	5777	5867	5953	6061	6241	6416	6596	6772	6952	
4	5912	6002	6088	6196	6376	6551	6731	6907	7087	



## 54251ULG20 GLIDER, 20" SEAT, UPH ARM, URETHANE CAP, LONG SKIRT, LOCKING MECHANISM

W: 27.5" D: 30" H: 42" SW: 20" SD: 19.5" SH: 18.5" AH: 24.75" WT: 65 lb COM: 4 yd WT CAP: 350 lb

ZONE	B/COM	C	D	E	F	G	H	I	J	GENERAL INFORMATION
1	5064	5144	5220	5316	5476	5632	5792	5948	6108	MATERIAL: -
2	5189	5269	5345	5441	5601	5757	5917	6073	6233	MOIS. BARR: Included
3	5314	5394	5470	5566	5726	5882	6042	6198	6358	
4	5439	5519	5595	5691	5851	6007	6167	6323	6483	

Urethane arm caps are available in black, sable or dove.

## 54251ULG22 GLIDER, 22" SEAT, UPH ARM, URETHANE CAP, LONG SKIRT, LOCKING MECHANISM

W: 29.5" D: 30" H: 42" SW: 22" SD: 19.5" SH: 18.5" AH: 24.75" WT: 68 lb COM: 4.25 yd WT CAP: 350 lb

ZONE	B/COM	C	D	E	F	G	H	I	J	GENERAL INFORMATION
1	5278	5363	5444	5546	5716	5882	6052	6217	6387	MATERIAL: -
2	5408	5493	5574	5676	5846	6012	6182	6347	6517	MOIS. BARR: Included
3	5538	5623	5704	5806	5976	6142	6312	6477	6647	
4	5669	5754	5835	5937	6107	6273	6443	6608	6778	

Urethane arm caps are available in black, sable or dove.

## 54251ULG24 GLIDER, 24" SEAT, UPH ARM, URETHANE CAP, LONG SKIRT, LOCKING MECHANISM

W: 31.5" D: 30" H: 42" SW: 24" SD: 19.5" SH: 18.5" AH: 24.75" WT: 71 lb COM: 4.5 yd WT CAP: 350 lb

ZONE	B/COM	C	D	E	F	G	H	I	J	GENERAL INFORMATION
1	5505	5595	5681	5789	5969	6144	6324	6500	6680	MATERIAL: -
2	5641	5731	5817	5925	6105	6280	6460	6636	6816	MOIS. BARR: Included
3	5777	5867	5953	6061	6241	6416	6596	6772	6952	
4	5912	6002	6088	6196	6376	6551	6731	6907	7087	

Urethane arm caps are available in black, sable or dove.

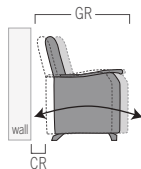

GR- Glider range from forward point to rear point is 41"

CR- Clearance required when placed against a wall is 7"

### Specify:

- Product Number
- Wood Finish
- Urethane Cap Color
- Fabric Vendor, Pattern and Color

See pages 16 & 17 for material and finish options.

# Versant Sleep Chairs



## 54841W24 SLEEP CHAIR, 24" SEAT, WOOD CAP

W: 32.5" D: 39" H: 31.25" SW: 24" SD: 21.75" SH: 17.5" AH: 24.5" WT: 130 lb COM: 6.75 yd WT CAP: 600 lb

ZONE	B/COM	C	D	E	F	G	H	I	J	GENERAL INFORMATION
1	8210	8345	8473	8635	8905	9169	9439	9702	9972	MATERIAL: Maple MOIS. BARR: Included
2	8413	8548	8676	8838	9108	9372	9642	9905	10175	
3	8615	8750	8878	9040	9310	9574	9844	10107	10377	
4	8818	8953	9081	9243	9513	9777	10047	10310	10580	

Versant sleep chairs are wallsavers designed with 0" clearance required to open the sleep surface if placed against a wall. Casters are standard. Glides are available at no upcharge.

## 54841W30 SLEEP CHAIR, 30" SEAT, WOOD CAP

W: 38.5" D: 39" H: 31.25" SW: 30" SD: 21.75" SH: 17.5" AH: 24.5" WT: 148 lb COM: 9.5 yd WT CAP: 600 lb

ZONE	B/COM	C	D	E	F	G	H	I	J	GENERAL INFORMATION
1	8872	9062	9243	9471	9851	10221	10601	10972	11352	MATERIAL: Maple MOIS. BARR: Included
2	9090	9280	9461	9689	10069	10439	10819	11190	11570	
3	9308	9498	9679	9907	10287	10657	11037	11408	11788	
4	9526	9716	9897	10125	10505	10875	11255	11626	12006	

Versant sleep chairs are wallsavers designed with 0" clearance required to open the sleep surface if placed against a wall. Casters are standard. Glides are available at no upcharge.

## 54841W48 SLEEP CHAIR, 48" SEAT, WOOD CAP

W: 56.5" D: 39" H: 31.25" SW: 48" SD: 21.75" SH: 17.5" AH: 24.5" WT: 202 lb COM: 10 yd WT CAP: 600 lb

ZONE	B/COM	C	D	E	F	G	H	I	J	GENERAL INFORMATION
1	10151	10351	10541	10781	11181	11571	11971	12361	12761	MATERIAL: Maple MOIS. BARR: Included
2	10401	10601	10791	11031	11431	11821	12221	12611	13011	
3	10651	10851	11041	11281	11681	12071	12471	12861	13261	
4	10900	11100	11290	11530	11930	12320	12720	13110	13510	

Versant sleep chairs are wallsavers designed with 0" clearance required to open the sleep surface if placed against a wall. Casters are standard. Glides are available at no upcharge.



## 54841U24 SLEEP CHAIR, 24" SEAT, URETHANE CAP

W: 32.5" D: 39" H: 31.25" SW: 24" SD: 21.75" SH: 17.5" AH: 24.5" WT: 133 lb COM: 6.75 yd WT CAP: 600 lb

ZONE	B/COM	C	D	E	F	G	H	I	J	GENERAL INFORMATION
1	8210	8345	8473	8635	8905	9169	9439	9702	9972	MATERIAL: - MOIS. BARR: Included
2	8413	8548	8676	8838	9108	9372	9642	9905	10175	
3	8615	8750	8878	9040	9310	9574	9844	10107	10377	
4	8818	8953	9081	9243	9513	9777	10047	10310	10580	

Versant sleep chairs are wallsavers designed with 0" clearance required to open the sleep surface if placed against a wall. Casters are standard. Glides are available at no upcharge. Urethane arm caps are available in black, sable or dove.

## 54841U30 SLEEP CHAIR, 30" SEAT, URETHANE CAP

W: 38.5" D: 39" H: 31.25" SW: 30" SD: 21.75" SH: 17.5" AH: 24.5" WT: 151 lb COM: 9.5 yd WT CAP: 600 lb

ZONE	B/COM	C	D	E	F	G	H	I	J	GENERAL INFORMATION
1	8872	9062	9243	9471	9851	10221	10601	10972	11352	MATERIAL: - MOIS. BARR: Included
2	9090	9280	9461	9689	10069	10439	10819	11190	11570	
3	9308	9498	9679	9907	10287	10657	11037	11408	11788	
4	9526	9716	9897	10125	10505	10875	11255	11626	12006	

Versant sleep chairs are wallsavers designed with 0" clearance required to open the sleep surface if placed against a wall. Casters are standard. Glides are available at no upcharge. Urethane arm caps are available in black, sable or dove.

## 54841U48 SLEEP CHAIR, 48" SEAT, URETHANE CAP

W: 56.5" D: 39" H: 31.25" SW: 48" SD: 21.75" SH: 17.5" AH: 24.5" WT: 205 lb COM: 10 yd WT CAP: 600 lb

ZONE	B/COM	C	D	E	F	G	H	I	J	GENERAL INFORMATION
1	10151	10351	10541	10781	11181	11571	11971	12361	12761	MATERIAL: - MOIS. BARR: Included
2	10401	10601	10791	11031	11431	11821	12221	12611	13011	
3	10651	10851	11041	11281	11681	12071	12471	12861	13261	
4	10900	11100	11290	11530	11930	12320	12720	13110	13510	

Versant sleep chairs are wallsavers designed with 0" clearance required to open the sleep surface if placed against a wall. Casters are standard. Glides are available at no upcharge. Urethane arm caps are available in black, sable or dove.

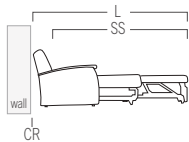

SS- Sleep surface 77"

CR- Clearance required to open sleep surface when placed against a wall is 0"

L- Overall length is 92"

Specify:

- Product Number
- Wood Finish
- Urethane Cap Color
- Fabric Vendor, Pattern and Color

See pages 16 & 17 for material and finish options.

# Versant Sleep Chairs



## 54841WM24 SLEEP CHAIR, 24" SEAT, MODERN WOOD CAP

W: 32.5" D: 39" H: 31.25" SW: 24" SD: 21.75" SH: 17.5" AH: 24.5" WT: 130 lb COM: 6.75 yd WT CAP: 600 lb

ZONE	B/COM	C	D	E	F	G	H	I	J	GENERAL INFORMATION
1	8210	8345	8473	8635	8905	9169	9439	9702	9972	MATERIAL: Maple
2	8413	8548	8676	8838	9108	9372	9642	9905	10175	MOIS. BARR: Included
3	8615	8750	8878	9040	9310	9574	9844	10107	10377	
4	8818	8953	9081	9243	9513	9777	10047	10310	10580	

Versant sleep chairs are wallsavers designed with 0" clearance required to open the sleep surface if placed against a wall. Casters are standard. Glides are available at no upcharge.

## 54841WM30 SLEEP CHAIR, 30" SEAT, MODERN WOOD CAP

W: 38.5" D: 39" H: 31.25" SW: 30" SD: 21.75" SH: 17.5" AH: 24.5" WT: 148 lb COM: 9.5 yd WT CAP: 600 lb

ZONE	B/COM	C	D	E	F	G	H	I	J	GENERAL INFORMATION
1	8872	9062	9243	9471	9851	10221	10601	10972	11352	MATERIAL: Maple
2	9090	9280	9461	9689	10069	10439	10819	11190	11570	MOIS. BARR: Included
3	9308	9498	9679	9907	10287	10657	11037	11408	11788	
4	9526	9716	9897	10125	10505	10875	11255	11626	12006	

Versant sleep chairs are wallsavers designed with 0" clearance required to open the sleep surface if placed against a wall. Casters are standard. Glides are available at no upcharge.

## 54841WM48 SLEEP CHAIR, 48" SEAT, MODERN WOOD CAP

W: 56.5" D: 39" H: 31.25" SW: 48" SD: 21.75" SH: 17.5" AH: 24.5" WT: 202 lb COM: 10 yd WT CAP: 600 lb

ZONE	B/COM	C	D	E	F	G	H	I	J	GENERAL INFORMATION
1	10151	10351	10541	10781	11181	11571	11971	12361	12761	MATERIAL: Maple
2	10401	10601	10791	11031	11431	11821	12221	12611	13011	MOIS. BARR: Included
3	10651	10851	11041	11281	11681	12071	12471	12861	13261	
4	10900	11100	11290	11530	11930	12320	12720	13110	13510	

Versant sleep chairs are wallsavers designed with 0" clearance required to open the sleep surface if placed against a wall. Casters are standard. Glides are available at no upcharge.



## 54841UM24 SLEEP CHAIR, 24" SEAT, MODERN URETHANE CAP

W: 32.5" D: 39" H: 31.25" SW: 24" SD: 21.75" SH: 17.5" AH: 24.5" WT: 130 lb COM: 6.75 yd WT CAP: 600 lb

ZONE	B/COM	C	D	E	F	G	H	I	J	GENERAL INFORMATION
1	8210	8345	8473	8635	8905	9169	9439	9702	9972	MATERIAL: -
2	8413	8548	8676	8838	9108	9372	9642	9905	10175	MOIS. BARR: Included
3	8615	8750	8878	9040	9310	9574	9844	10107	10377	
4	8818	8953	9081	9243	9513	9777	10047	10310	10580	

Versant sleep chairs are wallsavers designed with 0" clearance required to open the sleep surface if placed against a wall. Casters are standard. Glides are available at no upcharge. Urethane arm caps are available in black, sable or dove.

## 54841UM30 SLEEP CHAIR, 30" SEAT, MODERN URETHANE CAP

W: 38.5" D: 39" H: 31.25" SW: 30" SD: 21.75" SH: 17.5" AH: 24.5" WT: 151 lb COM: 9.5 yd WT CAP: 600 lb

ZONE	B/COM	C	D	E	F	G	H	I	J	GENERAL INFORMATION
1	8872	9062	9243	9471	9851	10221	10601	10972	11352	MATERIAL: -
2	9090	9280	9461	9689	10069	10439	10819	11190	11570	MOIS. BARR: Included
3	9308	9498	9679	9907	10287	10657	11037	11408	11788	
4	9526	9716	9897	10125	10505	10875	11255	11626	12006	

Versant sleep chairs are wallsavers designed with 0" clearance required to open the sleep surface if placed against a wall. Casters are standard. Glides are available at no upcharge. Urethane arm caps are available in black, sable or dove.

## 54841UM48 SLEEP CHAIR, 48" SEAT, MODERN URETHANE CAP

W: 56.5" D: 39" H: 31.25" SW: 48" SD: 21.75" SH: 17.5" AH: 24.5" WT: 205 lb COM: 10 yd WT CAP: 600 lb

ZONE	B/COM	C	D	E	F	G	H	I	J	GENERAL INFORMATION
1	10151	10351	10541	10781	11181	11571	11971	12361	12761	MATERIAL: -
2	10401	10601	10791	11031	11431	11821	12221	12611	13011	MOIS. BARR: Included
3	10651	10851	11041	11281	11681	12071	12471	12861	13261	
4	10900	11100	11290	11530	11930	12320	12720	13110	13510	

Versant sleep chairs are wallsavers designed with 0" clearance required to open the sleep surface if placed against a wall. Casters are standard. Glides are available at no upcharge. Urethane arm caps are available in black, sable or dove.

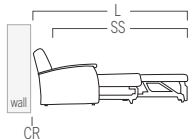

SS- Sleep surface 77"

CR- Clearance required to open sleep surface when placed against a wall is 0"

L- Overall length is 92"

Specify:

- Product Number
- Wood Finish
- Urethane Cap Color
- Fabric Vendor, Pattern and Color

See pages 16 & 17 for material and finish options.

# Wedgewood



## 7324004 CHAIR, WOOD ARM, LOW BACK

W: 24" D: 25.5" H: 33" SW: 20" SD: 18.75" SH: 18" AH: 25.75" WT: 28 lb COM: 1.5 yd WT CAP: 300 lb

ZONE	B/COM	C	D	E	F	G	H	I	J	GENERAL INFORMATION
1	2171	2201	2230	2266	2326	2384	2444	2503	2563	MATERIAL: Beech MOIS. BARR: \$8
2	2225	2255	2284	2320	2380	2438	2498	2557	2617	
3	2278	2308	2337	2373	2433	2491	2551	2610	2670	
4	2332	2362	2391	2427	2487	2545	2605	2664	2724	



## 7324005 CHAIR, WOOD ARM, MID BACK

W: 24" D: 25.5" H: 39" SW: 20" SD: 18.75" SH: 18" AH: 25.75" WT: 31 lb COM: 1.5 yd WT CAP: 300 lb

ZONE	B/COM	C	D	E	F	G	H	I	J	GENERAL INFORMATION
1	2272	2302	2331	2367	2427	2485	2545	2604	2664	MATERIAL: Beech MOIS. BARR: \$8
2	2328	2358	2387	2423	2483	2541	2601	2660	2720	
3	2384	2414	2443	2479	2539	2597	2657	2716	2776	
4	2441	2471	2500	2536	2596	2654	2714	2773	2833	

### Accessories

#### URETHANE ARM CAPS

\$247 2 Arms Available in black, sable or dove.

*Specify:*

- Product Number
- Wood Finish
- Urethane Finish
- Fabric Vendor, Pattern and Color

See pages 16 & 17 for material and finish options.

# Wedgewood Patient and Motion



## 7324006 PATIENT CHAIR, WOOD ARM, HIGH BACK

W: 24" D: 25.5" H: 43" SW: 20" SD: 18.75" SH: 18" AH: 25.75" WT: 33 lb COM: 2.2 yd WT CAP: 300 lb

ZONE	B/COM	C	D	E	F	G	H	I	J	GENERAL INFORMATION
1	2396	2440	2482	2535	2623	2709	2797	2882	2970	MATERIAL: Beech MOIS. BARR: \$8
2	2455	2499	2541	2594	2682	2768	2856	2941	3029	
3	2514	2558	2600	2653	2741	2827	2915	3000	3088	
4	2573	2617	2659	2712	2800	2886	2974	3059	3147	



## 7324009 MOTION CHAIR, WOOD ARM, MID BACK

W: 25" D: 26.5" H: 39" SW: 20.25" SD: 18.75" SH: 18" AH: 25.75" WT: 50 lb COM: 2.2 yd WT CAP: 300 lb

ZONE	B/COM	C	D	E	F	G	H	I	J	GENERAL INFORMATION
1	3228	3272	3314	3367	3455	3541	3629	3714	3802	MATERIAL: Beech MOIS. BARR: \$6
2	3308	3352	3394	3447	3535	3621	3709	3794	3882	
3	3388	3432	3474	3527	3615	3701	3789	3874	3962	
4	3467	3511	3553	3606	3694	3780	3868	3953	4041	

Leg extensions are not available on motion chairs. Casters (7144002) are available on rear legs only. Specify locking or non-locking. Non-skid glides are provided on the front legs



## 7324010 MOTION PATIENT CHAIR, WOOD ARM, HIGH BACK

W: 25" D: 26.5" H: 45" SW: 20.25" SD: 18.75" SH: 18" AH: 25.75" WT: 52 lb COM: 2.2 yd WT CAP: 300 lb

ZONE	B/COM	C	D	E	F	G	H	I	J	GENERAL INFORMATION
1	3333	3377	3419	3472	3560	3646	3734	3819	3907	MATERIAL: Beech MOIS. BARR: \$6
2	3415	3459	3501	3554	3642	3728	3816	3901	3989	
3	3498	3542	3584	3637	3725	3811	3899	3984	4072	
4	3580	3624	3666	3719	3807	3893	3981	4066	4154	

Leg extensions are not available on motion chairs. Casters (7144002) are available on rear legs only. Specify locking or non-locking. Non-skid glides are provided on the front legs



## 7024007 OTTOMAN, 10" HEIGHT

W: 19" D: 16" H: 10" SW: - SD: - SH: - AH: - WT: 9 lb COM: .4 yd WT CAP: 300 lb

ZONE	B/COM	C	D	E	F	G	H	I	J	GENERAL INFORMATION
1	1052	1060	1068	1078	1094	1109	1125	1141	1157	MATERIAL: Beech MOIS. BARR: \$5
2	1078	1086	1094	1104	1120	1135	1151	1167	1183	
3	1104	1112	1120	1130	1146	1161	1177	1193	1209	
4	1130	1138	1146	1156	1172	1187	1203	1219	1235	



## 7024008 OTTOMAN, 18" HEIGHT

W: 19" D: 16.75" H: 18" SW: - SD: - SH: - AH: - WT: 15 lb COM: .4 yd WT CAP: 300 lb

ZONE	B/COM	C	D	E	F	G	H	I	J	GENERAL INFORMATION
1	1052	1060	1068	1078	1094	1109	1125	1141	1157	MATERIAL: Beech MOIS. BARR: \$5
2	1078	1086	1094	1104	1120	1135	1151	1167	1183	
3	1104	1112	1120	1130	1146	1161	1177	1193	1209	
4	1130	1138	1146	1156	1172	1187	1203	1219	1235	

Cannot be used with motion chairs.

### Accessories

#### URETHANE ARM CAPS

\$247 2 Arms Available in black, sable or dove.

#### Specify:

- Product Number
- Wood Finish
- Urethane Cap Color
- Fabric Vendor, Pattern and Color

See pages 16 & 17 for material and finish options.

# Wedgewood Bariatric



## 7324058 BARIATRIC CHAIR, 20" SEAT, WOOD ARM

W: 24" D: 24.75" H: 35" SW: 20" SD: 18.75" SH: 18" AH: 25.75" WT: 30 lb COM: 1.5 yd WT CAP: 750 lb

ZONE	B/COM	C	D	E	F	G	H	I	J	GENERAL INFORMATION
1	2272	2302	2331	2367	2427	2485	2545	2604	2664	MATERIAL: Beech MOIS. BARR: \$8
2	2328	2358	2387	2423	2483	2541	2601	2660	2720	
3	2384	2414	2443	2479	2539	2597	2657	2716	2776	
4	2441	2471	2500	2536	2596	2654	2714	2773	2833	

## 7324054 BARIATRIC CHAIR, 25" SEAT, WOOD ARM

W: 29" D: 24.75" H: 35" SW: 25" SD: 18.75" SH: 18" AH: 25.75" WT: 36 lb COM: 2.3 yd WT CAP: 750 lb

ZONE	B/COM	C	D	E	F	G	H	I	J	GENERAL INFORMATION
1	2906	2952	2996	3051	3143	3232	3324	3414	3506	MATERIAL: Beech MOIS. BARR: \$16
2	2978	3024	3068	3123	3215	3304	3396	3486	3578	
3	3049	3095	3139	3194	3286	3375	3467	3557	3649	
4	3121	3167	3211	3266	3358	3447	3539	3629	3721	



## 7324055 BARIATRIC CHAIR, 30" SEAT, WOOD ARM

W: 34" D: 24.75" H: 35" SW: 30" SD: 18.75" SH: 18" AH: 25.75" WT: 40 lb COM: 2.3 yd WT CAP: 750 lb

ZONE	B/COM	C	D	E	F	G	H	I	J	GENERAL INFORMATION
1	3070	3116	3160	3215	3307	3396	3488	3578	3670	MATERIAL: Beech MOIS. BARR: \$17
2	3146	3192	3236	3291	3383	3472	3564	3654	3746	
3	3222	3268	3312	3367	3459	3548	3640	3730	3822	
4	3297	3343	3387	3442	3534	3623	3715	3805	3897	

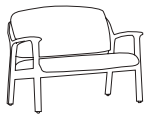

## 7324056 BARIATRIC LOVESEAT, 40" SEAT, WOOD ARM

W: 44" D: 24.75" H: 35" SW: 40" SD: 18.75" SH: 18" AH: 25.75" WT: 46 lb COM: 2.7 yd WT CAP: 750 lb

ZONE	B/COM	C	D	E	F	G	H	I	J	GENERAL INFORMATION
1	3237	3291	3343	3407	3515	3621	3729	3834	3942	MATERIAL: Beech MOIS. BARR: \$17
2	3317	3371	3423	3487	3595	3701	3809	3914	4022	
3	3397	3451	3503	3567	3675	3781	3889	3994	4102	
4	3477	3531	3583	3647	3755	3861	3969	4074	4182	



## 7324063 BARIATRIC CHAIR, 25" SEAT, WOOD ARM, MID-BACK

W: 29" D: 24.75" H: 39" SW: 25" SD: 18.75" SH: 18" AH: 25.75" WT: 39 lb COM: 2.5 yd WT CAP: 750 lb

ZONE	B/COM	C	D	E	F	G	H	I	J	GENERAL INFORMATION
1	3019	3069	3117	3177	3277	3374	3474	3572	3672	MATERIAL: Beech MOIS. BARR: \$17
2	3093	3143	3191	3251	3351	3448	3548	3646	3746	
3	3168	3218	3266	3326	3426	3523	3623	3721	3821	
4	3242	3292	3340	3400	3500	3597	3697	3795	3895	

## 7324064 BARIATRIC CHAIR, 30" SEAT, WOOD ARM, MID-BACK

W: 34" D: 24.75" H: 39" SW: 30" SD: 18.75" SH: 18" AH: 25.75" WT: 45 lb COM: 2.5 yd WT CAP: 750 lb

ZONE	B/COM	C	D	E	F	G	H	I	J	GENERAL INFORMATION
1	3183	3233	3281	3341	3441	3538	3638	3736	3836	MATERIAL: Beech MOIS. BARR: \$17
2	3262	3312	3360	3420	3520	3617	3717	3815	3915	
3	3340	3390	3438	3498	3598	3695	3795	3893	3993	
4	3419	3469	3517	3577	3677	3774	3874	3972	4072	

**Specify:**

- Product Number
- Wood Finish
- Urethane Cap Color
- Fabric Vendor, Pattern and Color

See pages 16 & 17 for material and finish options.

# Wedgewood Bariatric



## 7324065 BARIATRIC LOVESEAT, 40" SEAT, WOOD ARM, MID-BACK

W: 44" D: 24.75" H: 39" SW: 40" SD: 18.75" SH: 18" AH: 25.75" WT: 51 lb COM: 2.7 yd WT CAP: 750 lb

ZONE	B/COM	C	D	E	F	G	H	I	J	GENERAL INFORMATION
1	3344	3398	3450	3514	3622	3728	3836	3941	4049	MATERIAL: Beech MOIS. BARR: \$17
2	3427	3481	3533	3597	3705	3811	3919	4024	4132	
3	3509	3563	3615	3679	3787	3893	4001	4106	4214	
4	3592	3646	3698	3762	3870	3976	4084	4189	4297	

### Accessories



#### 7144001 REAR LOCKING CASTERS, FRONT NON-LOCKING CARPET SURFACE (SET OF FOUR)

STEM SIZE: 50 mm CASTER SIZE: 2"  
LOAD CAP: 110 lb p/caster WT: 1 lb

\$147

*Includes two front non-locking casters and two rear locking casters.*



#### 7144100 TIP BACK CASTERS (SET OF TWO)

\$134 per chair WT: 0.5 lb

#### URETHANE ARM CAPS

\$247 2 Arms Available in black, sable or dove.



#### 7144002 CASTERS, CARPET SURFACE (SET OF TWO)

STEM SIZE: 50 mm CASTER SIZE: 2"  
LOAD CAP: 110 lb p/caster WT: 0.5 lb

\$117

*Specify locking or non-locking for front or rear legs when ordering.*



#### 7144003 REAR LOCKING CASTERS, FRONT NON-LOCKING, HARD SURFACE (SET OF FOUR)

STEM SIZE: 50 mm CASTER SIZE: 2"  
LOAD CAP: 110 lb p/caster WT: 1 lb

\$147

*Includes two front non-locking casters and two rear locking casters.*



#### 7144004 CASTERS, HARD SURFACE (SET OF TWO)

STEM SIZE: 50 mm CASTER SIZE: 2"  
LOAD CAP: 110 lb p/caster WT: 0.5 lb

\$117

*Specify locking or non-locking for front or rear legs when ordering.*

#### Specify:

- Product Number
- Wood Finish
- Urethane Cap Color
- Fabric Vendor, Pattern and Color

See pages 16 & 17 for material and finish options.



## Tables

# 4700 Series Occasional Tables



## 4700-01 END TABLE, 22H 24W 24D

W: 24" D: 24" H: 22" WT: 57 lb

### GENERAL INFORMATION

TOP MATERIAL: Thermoform or Solid Surface  
BASE MATERIAL: Silver Metal

Zone	1	2	3	4
	1880	1927	1974	2021



## 4700-03 COFFEE TABLE, 17H 42W 24D

W: 42" D: 24" H: 17" WT: 76 lb

### GENERAL INFORMATION

TOP MATERIAL: Thermoform or Solid Surface  
BASE MATERIAL: Silver Metal

Zone	1	2	3	4
	2296	2353	2411	2468



## 4700-13 COFFEE TABLE WITH SHELF, 17H 42W 24D

W: 42" D: 24" H: 17" WT: 100 lb

### GENERAL INFORMATION

TOP MATERIAL: Thermoform or Solid Surface  
BASE MATERIAL: Silver Metal

Zone	1	2	3	4
	3080	3157	3234	3311



## 4700-05 CONSOLE TABLE, 29H 48W 18D

W: 48" D: 18" H: 29" WT: 75 lb

### GENERAL INFORMATION

TOP MATERIAL: Thermoform or Solid Surface  
BASE MATERIAL: Silver Metal

Zone	1	2	3	4
	2397	2457	2517	2577



## 4700-15 CONSOLE TABLE WITH SHELF, 29H 48W 18D

W: 48" D: 18" H: 29" WT: 83 lb

### GENERAL INFORMATION

TOP MATERIAL: Thermoform or Solid Surface  
BASE MATERIAL: Silver Metal

Zone	1	2	3	4
	2975	3049	3124	3198

### Table Top Options

#### SOLID SURFACE

\$742 Table

\$1186 Table w/Shelf

Specify solid surface color.

#### Specify:

- Product Number
- Thermoform Finish
- Solid Surface Name and Number

See pages 16 & 17 for material and finish options.

# Drum and Cube Occasional Tables

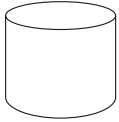

## DRUM

Product Number	Dimensions	Shape	Weight	Zone 1	Zone 2	Zone 3	Zone 4	2" Aluminum Laminate Kickplate Upcharge
0118D16H	18" DIA x 16" H	Round	34 lb	1281	1313	1345	1377	81
0118D18H	18" DIA x 18" H	Round	35 lb	1281	1313	1345	1377	81
0118D20H	18" DIA x 20" H	Round	36 lb	1281	1313	1345	1377	81
0118D22H	18" DIA x 22" H	Round	37 lb	1281	1313	1345	1377	81
0124D16H	24" DIA x 16" H	Round	48 lb	1352	1386	1420	1453	81
0124D18H	24" DIA x 18" H	Round	49 lb	1352	1386	1420	1453	81
0124D20H	24" DIA x 20" H	Round	50 lb	1352	1386	1420	1453	81
0124D22H	24" DIA x 22" H	Round	51 lb	1352	1386	1420	1453	81
0130D16H	30" DIA x 16" H	Round	62 lb	1697	1739	1782	1824	81
0130D18H	30" DIA x 18" H	Round	63 lb	1697	1739	1782	1824	81
0130D20H	30" DIA x 20" H	Round	64 lb	1697	1739	1782	1824	81
0130D22H	30" DIA x 22" H	Round	65 lb	1697	1739	1782	1824	81
0136D16H	36" DIA x 16" H	Round	77 lb	1923	1971	2019	2067	81
0136D18H	36" DIA x 18" H	Round	78 lb	1923	1971	2019	2067	81
0136D20H	36" DIA x 20" H	Round	79 lb	1923	1971	2019	2067	81
0136D22H	36" DIA x 22" H	Round	80 lb	1923	1971	2019	2067	81
0142D16H	42" DIA x 16" H	Round	94 lb	2134	2187	2241	2294	81
0142D18H	42" DIA x 18" H	Round	95 lb	2134	2187	2241	2294	81
0142D20H	42" DIA x 20" H	Round	96 lb	2134	2187	2241	2294	81
0142D22H	42" DIA x 22" H	Round	97 lb	2134	2187	2241	2294	81

Laminate with optional aluminum kickplate. Specify laminate and kickplate option if desired.

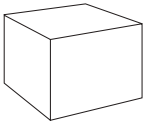

## CUBE

Product Number	Dimensions	Shape	Weight	Zone 1	Zone 2	Zone 3	Zone 4	2" Aluminum Laminate Kickplate Upcharge
0118SQ16H	16" H x 18" W x 18" L	Square	37 lb	972	996	1021	1045	81
0118SQ18H	18" H x 18" W x 18" L	Square	39 lb	972	996	1021	1045	81
0118SQ20H	20" H x 18" W x 18" L	Square	41 lb	972	996	1021	1045	81
0118SQ22H	22" H x 18" W x 18" L	Square	43 lb	972	996	1021	1045	81
0124SQ16H	16" H x 24" W x 24" L	Square	56 lb	1025	1051	1076	1102	81
0124SQ18H	18" H x 24" W x 24" L	Square	58 lb	1025	1051	1076	1102	81
0124SQ20H	20" H x 24" W x 24" L	Square	60 lb	1025	1051	1076	1102	81
0130SQ16H	16" H x 30" W x 30" L	Square	69 lb	1286	1318	1350	1382	81
0130SQ18H	18" H x 30" W x 30" L	Square	71 lb	1286	1318	1350	1382	81
0130SQ20H	20" H x 30" W x 30" L	Square	73 lb	1286	1318	1350	1382	81
0130SQ22H	22" H x 30" W x 30" L	Square	75 lb	1286	1318	1350	1382	81
0136SQ16H	16" H x 36" W x 36" L	Square	106 lb	1496	1533	1571	1608	81
0136SQ18H	18" H x 36" W x 36" L	Square	108 lb	1496	1533	1571	1608	81
0136SQ20H	20" H x 36" W x 36" L	Square	110 lb	1496	1533	1571	1608	81
0136SQ22H	22" H x 36" W x 36" L	Square	112 lb	1496	1533	1571	1608	81

Laminate with optional aluminum kickplate. Specify laminate and kickplate option if desired.

## Accessories



### COVC2P2U-B POWER, CLAMP MOUNTED

Black, 2 Power, 2 USB

### COVC2P2U-S POWER, CLAMP MOUNTED

Silver Pearl, 2 Power, 2 USB

### COVC2P2U-W POWER, CLAMP MOUNTED

Gloss White, 2 Power, 2 USB

\$687 All Colors

Cord is 108" long.

Specify:

- Product Number
- Laminate Vendor, Pattern and Finish
- Kickplate Option
- Power Option and Color
- Cord Opening Option

# Fuse Occasional Tables



## FUSE

Product Number	Dimensions	Shape	Weight	Zone 1	Zone 2	Zone 3	Zone 4
882424SQFVST118	18" H x 24" W x 24" L	Square	54 lb	1399	1434	1469	1504
883030SQFVST118	18" H x 30" W x 30" L	Square	64 lb	1574	1613	1653	1692
882448REFVST118	18" H x 48" W x 24" L	Rectangle	72 lb	1659	1700	1742	1783

Laminate top with metal base. Specify laminate, edge style and metal finish when ordering. Table ships unassembled.

### Edge Style Options



#### 2MM BIO EDGE

Available in 7 colors to match metal finishes.



#### SELF EDGE

Matches top laminate.



#### 2MM PVC WOOD GRAIN EDGE

Available in 9 wood grain colors to match standard laminates.

### Accessories



#### HARD CASTERS (FOR SOFT SURFACES)

\$145 per table

All bases are standard with floor-leveling glides. Casters are available on select models. See notes below product chart for availability.



#### VSC SEAM CONNECTOR

W: 2"      H: 5"      WT: .5 lb

\$143

To join and level tops. Includes 2 connectors, 4 thumb screws, 4 counter sunk threaded metal inserts. Standard in black.



#### SOFT CASTERS (FOR HARD SURFACES)

\$315 per table

All bases are standard with floor-leveling glides. Casters are available on select models. See notes below product chart for availability.

#### Specify:

- Product Number
- Finish
- Edge Style
- Laminate Vendor, Pattern and Finish

# Trumpet and Disc Occasional Tables



## TRUMPET ROUND

Product Number	Dimensions	Weight	Zone 1	Zone 2	Zone 3	Zone 4
8724DTR18	OCCASIONAL TABLE, 18" H x 24" L	61 lb	1064	1091	1117	1144
8730DTR18	OCCASIONAL TABLE, 18" H x 30" L	71 lb	1233	1264	1295	1325
8736DTR18	OCCASIONAL TABLE, 18" H x 36" L	82 lb	1395	1430	1465	1500
8742DTR18	OCCASIONAL TABLE, 18" H x 42" L	96 lb	1855	1901	1948	1994

Round laminate top with metal base. Specify laminate, edge style and metal finish when ordering. Table ships unassembled.



## TRUMPET SQUARE

Product Number	Dimensions	Weight	Zone 1	Zone 2	Zone 3	Zone 4
8718SQTR18	OCCASIONAL TABLE, 18" H x 18" W	54 lb	1098	1125	1153	1180
8724SQTR18	OCCASIONAL TABLE, 18" H x 24" W	61 lb	1115	1143	1171	1199
8730SQTR18	OCCASIONAL TABLE, 18" H x 30" W	71 lb	1288	1320	1352	1385
8736SQTR18	OCCASIONAL TABLE, 18" H x 36" W	82 lb	1425	1461	1496	1532

Square laminate top with metal base. Specify laminate, edge style finish and metal finish when ordering. Table ships unassembled.



## DISC ROUND

Product Number	Dimensions	Weight	Zone 1	Zone 2	Zone 3	Zone 4
8724DDISC18	END TABLE, 18" H x 24" L	71 lb	1576	1615	1655	1694
8730DDISC18	END TABLE, 18" H x 30" L	81 lb	1743	1787	1830	1874
8736DDISC18	END TABLE, 18" H x 36" L	92 lb	1903	1951	1998	2046
8742DDISC18	END TABLE, 18" H x 42" L	116 lb	2366	2425	2484	2543

Round laminate top with metal base. Specify laminate, edge style and metal finish when ordering. Table ships unassembled.



## DISC SQUARE

Product Number	Dimensions	Weight	Zone 1	Zone 2	Zone 3	Zone 4
8718SQDISC18	END TABLE, 18" H x 18" W	54 lb	1605	1645	1685	1725
8724SQDISC18	END TABLE, 18" H x 24" W	61 lb	1624	1665	1705	1746
8730SQDISC18	END TABLE, 18" H x 30" W	91 lb	1798	1843	1888	1933
8736SQDISC18	END TABLE, 18" H x 36" W	102 lb	1934	1982	2031	2079

Square laminate top with metal base. Specify laminate, edge style and metal finish when ordering. Table ships unassembled.

### Edge Style Options



#### FLAT PVC EDGE

Available in 7 colors to match metal finishes.



#### SELF EDGE

Matches top laminate.



#### 2MM BIO EDGE

Available in 7 colors to match metal finishes.



#### 2MM PVC WOOD GRAIN EDGE

Available in 9 wood grain colors to match standard laminates.

Specify:

- Product Number
- Finish
- Edge Style
- Laminate Vendor, Pattern and Finish

# Fuse Multi-purpose Tables



## FUSE

Product Number	Dimensions	Shape	Weight	Zone 1	Zone 2	Zone 3	Zone 4
882424SQFVST129	24" W x 24" L	Square	54 lb	1399	1434	1469	1504
883030SQFVST129	30" W x 30" L	Square	64 lb	1575	1614	1654	1693
883636SQFVST129	36" W x 36" L	Square	76 lb	1705	1748	1790	1833
881848REFVST129	48" W x 18" L	Rectangle	64 lb	1585	1625	1664	1704
881860REFVST129	60" W x 18" L	Rectangle	72 lb	1659	1700	1742	1783
881872REFVST129	72" W x 18" L	Rectangle	79 lb	1757	1801	1845	1889
882430REFVST129	30" W x 24" L	Rectangle	58 lb	1552	1591	1630	1668
882436REFVST129	36" W x 24" L	Rectangle	63 lb	1552	1591	1630	1668
882442REFVST129	42" W x 24" L	Rectangle	68 lb	1659	1700	1742	1783
882448REFVST129	48" W x 24" L	Rectangle	72 lb	1659	1700	1742	1783
882460REFVST129	60" W x 24" L	Rectangle	82 lb	1757	1801	1845	1889
882472REFVST129	72" W x 24" L	Rectangle	91 lb	1998	2048	2098	2148
883036REFVST129	36" W x 30" L	Rectangle	69 lb	1705	1748	1790	1833
883042REFVST129	42" W x 30" L	Rectangle	75 lb	1742	1786	1829	1873
883048REFVST129	48" W x 30" L	Rectangle	81 lb	1742	1786	1829	1873
883060REFVST129	60" W x 30" L	Rectangle	92 lb	1839	1885	1931	1977
883072REFVST129	72" W x 30" L	Rectangle	103 lb	2217	2272	2328	2383
883642REFVST129	42" W x 36" L	Rectangle	82 lb	1906	1954	2001	2049
883648REFVST129	48" W x 36" L	Rectangle	89 lb	1947	1996	2044	2093
883660REFVST129	60" W x 36" L	Rectangle	102 lb	2105	2158	2210	2263
883672REFVST129	72" W x 36" L	Rectangle	115 lb	2315	2373	2431	2489

Overall height is 29". Casters are available on all sizes. See accessories section for accessory pricing. Table ships unassembled.

### Edge Style Options



#### 2MM BIO EDGE

Available in 7 colors to match metal finishes.



#### SELF EDGE

Matches top laminate.



#### 2MM PVC WOOD GRAIN EDGE

Available in 9 wood grain colors to match standard laminates.

### Accessories



#### HARD CASTERS (FOR SOFT SURFACES)

\$145 per table

All bases are standard with floor-leveling glides. Casters are available on select models. See notes below product chart for availability.



#### VSC SEAM CONNECTOR

W: 2"      H: 5"      WT: .5 lb  
\$143

To join and level tops. Includes 2 connectors, 4 thumb screws, 4 counter sunk threaded metal inserts. Standard in black.



#### SOFT CASTERS (FOR HARD SURFACES)

\$315 per table

All bases are standard with floor-leveling glides. Casters are available on select models. See notes below product chart for availability.

Specify:

- Product Number
- Finish
- Edge Style
- Laminate Vendor, Pattern and Finish

# Trumpet and Disc Multi-purpose Tables



## TRUMPET

Product Number	Dimensions	Shape	Weight	Zone 1	Zone 2	Zone 3	Zone 4
8724DTR29	24" DIA x 29" H	Round	61 lb	1064	1091	1117	1144
8730DTR29	30" DIA x 29" H	Round	71 lb	1233	1264	1295	1325
8736DTR29	36" DIA x 29" H	Round	82 lb	1395	1430	1465	1500
8742DTR29	42" DIA x 29" H	Round	96 lb	1855	1901	1948	1994
8748DTR29	48" DIA x 29" H	Round	112 lb	1893	1940	1988	2035
8724SQTR29	24" W x 29" H	Square	61 lb	1115	1143	1171	1199
8730SQTR29	30" W x 29" H	Square	71 lb	1225	1256	1286	1317
8736SQTR29	36" W x 29" H	Square	82 lb	1425	1461	1496	1532

Round or square laminate top with metal base. Specify laminate, edge style and metal finish when ordering. Table ships unassembled.



## DISC

Product Number	Dimensions	Shape	Weight	Zone 1	Zone 2	Zone 3	Zone 4
8724DDISC29	24" DIA x 29" H	Round	71 lb	1545	1584	1622	1661
8730DDISC29	30" DIA x 29" H	Round	81 lb	1709	1752	1794	1837
8736DDISC29	36" DIA x 29" H	Round	92 lb	1763	1807	1851	1895
8742DDISC29	42" DIA x 29" H	Round	116 lb	1866	1913	1959	2006
8748DDISC29	48" DIA x 29" H	Round	132 lb	1896	1943	1991	2038
8730SQDISC29	30" W x 29" H	Square	91 lb	2320	2378	2436	2494
8736SQDISC29	36" W x 29" H	Square	102 lb	2357	2416	2475	2534

Round or square laminate top with metal base. Specify laminate, edge style and metal finish when ordering. Table ships unassembled.

### Edge Style Options



#### FLAT PVC EDGE

Available in 7 colors to match metal finishes.



#### SELF EDGE

Matches top laminate.



#### 2MM BIO EDGE

Available in 7 colors to match metal finishes.



#### 2MM PVC WOOD GRAIN EDGE

Available in 9 wood grain colors to match standard laminates.

#### Specify:

- Product Number
- Metal Finish
- Edge Style and Finish
- Laminate Vendor, Pattern and Finish

See pages 16 & 17 for material and finish options.

# Tubular Multi-purpose Tables

## X-BASE



Product Number	Flip-Top Option	Dimensions	Shape	Weight	Zone 1	Zone 2	Zone 3	Zone 4
8624DX	•	24" DIA	Round	37 lb	855	876	898	919
8630DX	•	30" DIA	Round	47 lb	1027	1053	1078	1104
8636DX	•	36" DIA	Round	58 lb	1190	1220	1250	1279
8642DX	•	42" DIA	Round	72 lb	1658	1699	1741	1782
8648DX	•	48" DIA	Round	88 lb	1697	1739	1782	1824
8624SQX	•	24" W x 24" L	Square	37 lb	907	930	952	975
8630SQX	•	30" W x 30" L	Square	47 lb	1084	1111	1138	1165
8636SQX	•	36" W x 36" L	Square	58 lb	1221	1252	1282	1313
8642SQX	•	42" W x 42" L	Square	92 lb	1937	1985	2034	2082
862430REX	•	24" W x 30" L	Rectangle	46 lb	1065	1092	1118	1145
862436REX	•	24" W x 36" L	Rectangle	46 lb	1065	1092	1118	1145
863036REX	•	30" W x 36" L	Rectangle	52 lb	1221	1252	1282	1313
863042REX	•	30" W x 42" L	Rectangle	62 lb	1257	1288	1320	1351
863048REX	•	30" W x 48" L	Rectangle	62 lb	1257	1288	1320	1351

One base per table; overall height is 29". Flip-top option is available in all sizes. Casters are available on 48" round and 24", 30", and 36" square table only. See accessories section for accessory pricing. Table ships unassembled.

## X-BASE, BAR HEIGHT

Product Number	Dimensions	Shape	Weight	Zone 1	Zone 2	Zone 3	Zone 4
8624DX41	24" DIA	Round	39 lb	920	943	966	989
8630DX41	30" DIA	Round	49 lb	1091	1118	1146	1173
8636DX41	36" DIA	Round	60 lb	1256	1287	1319	1350
8624SQX41	24" W x 24" L	Square	39 lb	972	996	1021	1045
8630SQX41	30" W x 30" L	Square	49 lb	1150	1179	1208	1236
8636SQX41	36" W x 36" L	Square	60 lb	1286	1318	1350	1382

One base per table; overall height is 41". Flip-top option and casters are not available. Table ships unassembled.



## 4-COLUMN, X-BASE

Product Number	Dimensions	Shape	Weight	Zone 1	Zone 2	Zone 3	Zone 4
8642DX4	42" DIA	Round	87 lb	1982	2032	2081	2131
8648DX4	48" DIA	Round	103 lb	2021	2072	2122	2173
8654DX4	54" DIA	Round	121 lb	2497	2559	2622	2684
8660DX4	60" DIA	Round	140 lb	2572	2636	2701	2765
8642SQX4	42" W x 42" L	Square	87 lb	2005	2055	2105	2155
8648SQX4	48" W x 48" L	Square	103 lb	2261	2318	2374	2431
8654SQX4	54" W x 54" L	Square	121 lb	2502	2565	2627	2690
8660SQX4	60" W x 60" L	Square	140 lb	2555	2619	2683	2747

One base per table; overall height is 29". Flip-top option not available. Casters are available on 42" and 48" tables only. See accessories section for accessory pricing. Table ships unassembled.

### Specify:

- Product Number
- Metal Finish
- Edge Style and Finish
- Grommet Position
- Laminate Vendor, Pattern and Finish
- Modesty Panel Finish
- Power Option and Color
- Flip-Top Option

See pages 16 & 17 for material and finish options.

# Tubular Multi-purpose Tables



## T-BASE

Product Number	Flip-Top Option	Folding Option	Dimensions	Shape	Weight	Zone 1	Zone 2	Zone 3	Zone 4
862430RET	•		24" W x 30" L	Rectangle	54 lb	1248	1279	1310	1342
862436RET	•		24" W x 36" L	Rectangle	54 lb	1248	1279	1310	1342
862442RET	•		24" W x 42" L	Rectangle	62 lb	1357	1391	1425	1459
862448RET	•		24" W x 48" L	Rectangle	62 lb	1357	1391	1425	1459
862454RET	•		24" W x 54" L	Rectangle	70 lb	1456	1492	1529	1565
862460RET	•	•	24" W x 60" L	Rectangle	70 lb	1456	1492	1529	1565
862466RET	•	•	24" W x 66" L	Rectangle	79 lb	1701	1744	1786	1829
862472RET	•	•	24" W x 72" L	Rectangle	79 lb	1701	1744	1786	1829
863036RET	•		30" W x 36" L	Rectangle	60 lb	1404	1439	1474	1509
863042RET	•		30" W x 42" L	Rectangle	70 lb	1440	1476	1512	1548
863048RET	•		30" W x 48" L	Rectangle	70 lb	1440	1476	1512	1548
863054RET	•		30" W x 54" L	Rectangle	81 lb	1535	1573	1612	1650
863060RET	•	•	30" W x 60" L	Rectangle	81 lb	1535	1573	1612	1650
863066RET	•	•	30" W x 66" L	Rectangle	91 lb	1829	1875	1920	1966
863072RET	•	•	30" W x 72" L	Rectangle	91 lb	1925	1973	2021	2069
863078RET	•	•	30" W x 78" L	Rectangle	102 lb	2303	2361	2418	2476
863084RET	•	•	30" W x 84" L	Rectangle	102 lb	2303	2361	2418	2476
863090RET		•	30" W x 90" L	Rectangle	112 lb	2339	2397	2456	2514
863096RET		•	30" W x 96" L	Rectangle	112 lb	2339	2397	2456	2514
863642RET	•		36" W x 42" L	Rectangle	79 lb	1609	1649	1689	1730
863648RET	•		36" W x 48" L	Rectangle	79 lb	1649	1690	1731	1773
863660RET	•	•	36" W x 60" L	Rectangle	91 lb	1812	1857	1903	1948
863666RET	•	•	36" W x 66" L	Rectangle	104 lb	1960	2009	2058	2107
863672RET	•	•	36" W x 72" L	Rectangle	104 lb	2024	2075	2125	2176
863678RET		•	36" W x 78" L	Rectangle	117 lb	2587	2652	2716	2781
863684RET		•	36" W x 84" L	Rectangle	117 lb	2587	2652	2716	2781
863690RET			36" W x 90" L	Rectangle	129 lb	2597	2662	2727	2792
863696RET			36" W x 96" L	Rectangle	129 lb	2597	2662	2727	2792
863654RTT	•		36" W x 54" L	Racetrack	91 lb	1905	1953	2000	2048
863660RTT	•		36" W x 60" L	Racetrack	91 lb	1905	1953	2000	2048
863666RTT	•		36" W x 66" L	Racetrack	104 lb	2171	2225	2280	2334
863672RTT	•		36" W x 72" L	Racetrack	104 lb	2171	2225	2280	2334
863678RTT			36" W x 78" L	Racetrack	117 lb	2615	2680	2746	2811
863684RTT			36" W x 84" L	Racetrack	117 lb	2615	2680	2746	2811
863690RTT			36" W x 90" L	Racetrack	129 lb	2620	2686	2751	2816
863696RTT			36" W x 96" L	Racetrack	129 lb	2620	2686	2751	2816
863054BT	•		30" W x 54" L	Bullet	81 lb	1740	1784	1827	1870
863060BT	•		30" W x 60" L	Bullet	81 lb	1827	1873	1918	1964
863654BT	•		36" W x 54" L	Bullet	91 lb	1944	1993	2041	2090
863660BT	•		36" W x 60" L	Bullet	91 lb	1944	1993	2041	2090
863672BT	•		36" W x 72" L	Bullet	104 lb	2169	2223	2277	2332
862448HT	•		24" W x 48" L	Half Moon	62 lb	1382	1417	1451	1486
863060HT	•		30" W x 60" L	Half Moon	81 lb	1641	1682	1723	1764
863672HT	•		36" W x 72" L	Half Moon	104 lb	2169	2223	2277	2332
863060TPT	•		30" W x 60" L	Trapezoid	81 lb	1740	1784	1827	1870
863672TPT	•		36" W x 72" L	Trapezoid	104 lb	2169	2223	2277	2332

Top View:



Rectangle



Racetrack



Bullet



Half Moon

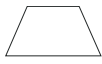

Trapezoid

Specify:

- Product Number
- Finish
- Edge Style
- Grommet Position
- Laminate Vendor, Pattern and Finish
- Modesty Panel Finish
- Power Option and Color
- Flip-Top Option
- Folding Option

See pages 16 & 17 for material and finish options.

Two bases per table; overall height is 29". Flip-top option is not available on 30" tables longer than 84" or 36" tables longer than 72". Casters are available on all sizes. Table ships unassembled. Folding tables available with Flat PVC Edge only. A table can either be Flip-top or Folding, but not both when available.

# Tubular Tables

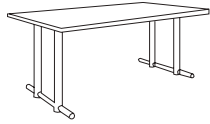

## DOUBLE COLUMN, T-BASE

Product Number	Folding Option	Dimensions	Shape	Weight	Zone 1	Zone 2	Zone 3	Zone 4
863666RET2	•	36" W x 66" L	Rectangle	124 lb	2295	2352	2410	2467
863672RET2	•	36" W x 72" L	Rectangle	124 lb	2356	2415	2474	2533
863678RET2	•	36" W x 78" L	Rectangle	137 lb	2920	2993	3066	3139
863684RET2	•	36" W x 84" L	Rectangle	137 lb	2920	2993	3066	3139
863690RET2	•	36" W x 90" L	Rectangle	149 lb	2931	3004	3078	3151
863696RET2	•	36" W x 96" L	Rectangle	149 lb	2931	3004	3078	3151
864278RET2	•	42" W x 78" L	Rectangle	151 lb	3329	3412	3495	3579
864284RET2	•	42" W x 84" L	Rectangle	151 lb	3329	3412	3495	3579
863654RTT2		36" W x 54" L	Racetrack	111 lb	2242	2298	2354	2410
863660RTT2		36" W x 60" L	Racetrack	111 lb	2242	2298	2354	2410
863666RTT2		36" W x 66" L	Racetrack	124 lb	2507	2570	2632	2695
863672RTT2		36" W x 72" L	Racetrack	124 lb	2507	2570	2632	2695
863678RTT2		36" W x 78" L	Racetrack	132 lb	2951	3025	3099	3172
863684RTT2		36" W x 84" L	Racetrack	132 lb	2951	3025	3099	3172
863690RTT2		36" W x 90" L	Racetrack	149 lb	2955	3029	3103	3177
863696RTT2		36" W x 96" L	Racetrack	149 lb	2955	3029	3103	3177
864278RTT2		42" W x 78" L	Racetrack	166 lb	3354	3438	3522	3606
864284RTT2		42" W x 84" L	Racetrack	166 lb	3354	3438	3522	3606
864878RTT2		48" W x 78" L	Racetrack	166 lb	3358	3442	3526	3610
864884RTT2		48" W x 84" L	Racetrack	166 lb	3358	3442	3526	3610

Two bases per table; overall height is 29". Flip-top option not available. Casters are available on all sizes. See accessories section for accessory pricing. Table ships unassembled. Folding tables available with Flat PVC Edge only.

## CONNECTOR TABLE

Product Number	Dimensions	Shape	Weight	Zone 1	Zone 2	Zone 3	Zone 4
8624RC90	24" W x 24" L	Radius	17 lb	651	667	684	700
8630RC90	30" W x 30" L	Radius	27 lb	830	851	872	892
863036CRC90T	30" W x 36" L	Crescent	46 lb	1329	1362	1395	1429
863642CRC90T	36" W x 42" L	Crescent	59 lb	1925	1973	2021	2069

Height is 29".

### Specify:

- Product Number
- Finish
- Edge Style
- Grommet Position
- Laminate Vendor, Pattern and Finish
- Modesty Panel Finish
- Power Option and Color
- Folding Option

See pages 16 & 17 for material and finish options.

### Edge Style Options



#### FLAT PVC EDGE

Available in 7 colors to match metal finishes.



#### SELF EDGE

Matches top laminate.



#### 2MM BIO EDGE

Available in 7 colors to match metal finishes.



#### 2MM PVC WOOD GRAIN EDGE

Available in 9 wood grain colors to match standard laminates.

# Tubular Accessories

## Accessories



### HARD CASTERS (FOR SOFT SURFACES)

\$145 per table

All bases are standard with floor-leveling glides. Casters are available on select models. See notes below products chart for availability.



### SOFT CASTERS (FOR HARD SURFACES)

\$315 per table

All bases are standard with floor-leveling glides. Casters are available on select models. See notes below products chart for availability.



### FLIP-TOP OPTION

\$240 Tables with One Base  
\$480 Tables with Two Bases

Available on select products. See product chart for availability.

### FOLDING OPTION

\$987 Tables Smaller than 72" L  
\$1232 Tables 72" L or Larger

Available on select sizes with Flat PVC Edge only.

### WHEELCHAIR HEIGHT UPCHARGE

\$64

Recommended wheelchair height is 31". For Tubular tables with X and T base with or without casters or modesty panels.



### CTRS ROUND GROMMET

DIA: 2" H: 1" WT: .2 lb

\$42

Available positioned at left, right, and/or center - specify location(s) when ordering.

### CTRG OVAL GROMMET

W: 3" L: 5" H: 1" WT: .2 lb

\$67

Available positioned at left, right, and/or center - specify location(s) when ordering.



### CSC SEAM CONNECTOR

W: 2" H: 5" WT: .5 lb

\$155

To join and level tops. Includes 2 connectors, 4 thumb screws, 4 counter sunk threaded metal inserts.



### PMP-SR42 MODESTY PANEL

Fits 42" Top Size L: 39" H: 10" WT: 6 lb

### PMP-SR48 MODESTY PANEL

Fits 48" Top Size L: 45" H: 10" WT: 6 lb

### PMP-SR54 MODESTY PANEL

Fits 54" Top Size L: 51" H: 10" WT: 7 lb

### PMP-SR60 MODESTY PANEL

Fits 60" Top Size L: 57" H: 10" WT: 8 lb

### PMP-SR66 MODESTY PANEL

Fits 66" Top Size L: 63" H: 10" WT: 9 lb

### PMP-SR72 MODESTY PANEL

Fits 72" Top Size L: 69" H: 10" WT: 10 lb

\$473 All Sizes

Available on rectangle top tables 42" – 72" in length. Perforated metal panel available in black or silver—specify color when ordering. Panel is hinged when used in conjunction with flip-top option.



### COVC2P2U-B POWER, CLAMP MOUNTED

Black, 2 Power, 2 USB

### COVC2P2U-S POWER, CLAMP MOUNTED

Silver Pearl, 2 Power, 2 USB

### COVC2P2U-W POWER, CLAMP MOUNTED

Gloss White, 2 Power, 2 USB

\$687 All Colors

Cord is 108" long.



### CWMT PVC SNAP TO LEG WIRE MANAGER

\$64



### VELCROWIREMGR VELCRO WIRE MANAGER

\$21



## Task Chairs

# Delta with Casters



## 82DT35UP UPH SEAT AND BACK, CASTERS, 18"

W: 22"	D: 21.5"	H: 32"	SW: 18.5"	SD: 18"	SH: 18"	AH: -	WT: 16 lb	COM: .7 yd	WT CAP: 500 lb	
ZONE	B/COM	C	D	E	F	G	H	I	J	GENERAL INFORMATION
1	1044	1058	1072	1088	1116	1144	1172	1199		MATERIAL: Metal
2	1070	1084	1098	1114	1142	1170	1198	1225		MOIS. BARR: -
3	1096	1110	1124	1140	1168	1196	1224	1251		1/2" SEAT FOAM: \$24
4	1121	1135	1149	1165	1193	1221	1249	1276		

Price includes hard casters (for soft surfaces). Four chairs nest 44" deep, each additional chair adds 8".

## 83DT15UP UPH SEAT AND BACK, CASTERS, 22"

W: 24"	D: 21.5"	H: 32"	SW: 22"	SD: 18"	SH: 18"	AH: -	WT: 20.5 lb	COM: .7 yd	WT CAP: 500 lb	
ZONE	B/COM	C	D	E	F	G	H	I	J	GENERAL INFORMATION
1	1120	1134	1148	1164	1192	1220	1248	1275		MATERIAL: Metal
2	1148	1162	1176	1192	1220	1248	1276	1303		MOIS. BARR: -
3	1175	1189	1203	1219	1247	1275	1303	1330		1/2" SEAT FOAM: \$37
4	1203	1217	1231	1247	1275	1303	1331	1358		

Price includes hard casters (for soft surfaces). Four chairs nest 44" deep, each additional chair adds 8".

## 82DT35US UPH SEAT AND PLASTIC BACK, CASTERS, 18"

W: 22"	D: 21.5"	H: 32"	SW: 18.5"	SD: 18"	SH: 18"	AH: -	WT: 16 lb	COM: .35 yd	WT CAP: 500 lb	
ZONE	B/COM	C	D	E	F	G	H	I	J	GENERAL INFORMATION
1	988	995	1001	1010	1024	1037	1051	1065		MATERIAL: Metal
2	1013	1020	1026	1035	1049	1062	1076	1090		MOIS. BARR: -
3	1037	1044	1050	1059	1073	1086	1100	1114		1/2" SEAT FOAM: \$24
4	1062	1069	1075	1084	1098	1111	1125	1139		

Price includes hard casters (for soft surfaces). Four chairs nest 44" deep, each additional chair adds 8".

## 83DT15US UPH SEAT AND PLASTIC BACK, CASTERS, 22"

W: 24"	D: 21.5"	H: 32"	SW: 22"	SD: 18"	SH: 18"	AH: -	WT: 20.5 lb	COM: .35 yd	WT CAP: 500 lb	
ZONE	B/COM	C	D	E	F	G	H	I	J	GENERAL INFORMATION
1	1061	1068	1074	1083	1097	1110	1124	1138		MATERIAL: Metal
2	1087	1094	1100	1109	1123	1136	1150	1164		MOIS. BARR: -
3	1114	1121	1127	1136	1150	1163	1177	1191		1/2" SEAT FOAM: \$37
4	1140	1147	1153	1162	1176	1189	1203	1217		

Price includes hard casters (for soft surfaces). Four chairs nest 44" deep, each additional chair adds 8".

## 82DT35 PLASTIC SEAT AND BACK, CASTERS, 18"

W: 22"	D: 21.5"	H: 32"	SW: 18.5"	SD: 18"	SH: 18"	AH: -	WT: 16 lb	COM: -	WT CAP: 500 lb	
Zone	1	2	3	4	GENERAL INFORMATION					
	820	840	861	882	MATERIAL: Metal					
					MOIS. BARR: -					

Price includes hard casters (for soft surfaces). Four chairs nest 44" deep, each additional chair adds 8".

## 83DT15 PLASTIC SEAT AND BACK, CASTERS, 22"

W: 24"	D: 21.5"	H: 32"	SW: 22"	SD: 18"	SH: 18"	AH: -	WT: 20.5 lb	COM: -	WT CAP: 500 lb	
Zone	1	2	3	4	GENERAL INFORMATION					
	877	899	921	943	MATERIAL: Metal					
					MOIS. BARR: -					

Price includes hard casters (for soft surfaces). Four chairs nest 44" deep, each additional chair adds 8".

**Specify:**

- Product Number
- Seat Finish
- Back Finish
- Fabric Vendor, Pattern and Color
- Metal Finish

See pages 16 & 17 for material and finish options.

**Accessories**

**SOFT CASTERS (FOR HARD SURFACES)**

\$35

# Delta with Glides



## 82DT34UP UPH SEAT AND BACK, GLIDES, 18"

W: 22" D: 21.5" H: 32" SW: 18.5" SD: 18" SH: 18" AH: - WT: 16 lb COM: .7 yd WT CAP: 500 lb

ZONE	B/COM	C	D	E	F	G	H	I	J	GENERAL INFORMATION
1	1044	1058	1072	1088	1116	1144	1172	1199		MATERIAL: Metal
2	1070	1084	1098	1114	1142	1170	1198	1225		MOIS. BARR: -
3	1096	1110	1124	1140	1168	1196	1224	1251		1/2" SEAT FOAM: \$24
4	1121	1135	1149	1165	1193	1221	1249	1276		

Four chairs nest 44" deep, each additional chair adds 8".

## 83DT14UP UPH SEAT AND BACK, GLIDES, 22"

W: 24" D: 21.5" H: 32" SW: 22" SD: 18" SH: 18" AH: - WT: 20.5 lb COM: .7 yd WT CAP: 500 lb

ZONE	B/COM	C	D	E	F	G	H	I	J	GENERAL INFORMATION
1	1120	1134	1148	1164	1192	1220	1248	1275		MATERIAL: Metal
2	1148	1162	1176	1192	1220	1248	1276	1303		MOIS. BARR: -
3	1175	1189	1203	1219	1247	1275	1303	1330		1/2" SEAT FOAM: \$37
4	1203	1217	1231	1247	1275	1303	1331	1358		

Four chairs nest 44" deep, each additional chair adds 8".

## 82DT34US UPH SEAT AND PLASTIC BACK, GLIDES, 18"

W: 22" D: 21.5" H: 32" SW: 18.5" SD: 18" SH: 18" AH: - WT: 16 lb COM: .35 yd WT CAP: 500 lb

ZONE	B/COM	C	D	E	F	G	H	I	J	GENERAL INFORMATION
1	988	995	1001	1010	1024	1037	1051	1065		MATERIAL: Metal
2	1013	1020	1026	1035	1049	1062	1076	1090		MOIS. BARR: -
3	1037	1044	1050	1059	1073	1086	1100	1114		1/2" SEAT FOAM: \$24
4	1062	1069	1075	1084	1098	1111	1125	1139		

Four chairs nest 44" deep, each additional chair adds 8".

## 83DT14US UPH SEAT AND PLASTIC BACK, GLIDES, 22"

W: 24" D: 21.5" H: 32" SW: 22" SD: 18" SH: 18" AH: - WT: 20.5 lb COM: .35 yd WT CAP: 500 lb

ZONE	B/COM	C	D	E	F	G	H	I	J	GENERAL INFORMATION
1	1061	1068	1074	1083	1097	1110	1124	1138		MATERIAL: Metal
2	1087	1094	1100	1109	1123	1136	1150	1164		MOIS. BARR: -
3	1114	1121	1127	1136	1150	1163	1177	1191		1/2" SEAT FOAM: \$37
4	1140	1147	1153	1162	1176	1189	1203	1217		

Four chairs nest 44" deep, each additional chair adds 8".

## 82DT34 PLASTIC SEAT AND BACK, GLIDES, 18"

W: 22" D: 21.5" H: 32" SW: 18.5" SD: 18" SH: 18" AH: - WT: 16 lb COM: - WT CAP: 500 lb

Zone	1	2	3	4	GENERAL INFORMATION
	820	840	861	882	MATERIAL: Metal
					MOIS. BARR: -

Four chairs nest 44" deep, each additional chair adds 8".

## 83DT14 PLASTIC SEAT AND BACK, GLIDES, 22"

W: 24" D: 21.5" H: 32" SW: 22" SD: 18" SH: 18" AH: - WT: 20.5 lb COM: - WT CAP: 500 lb

Zone	1	2	3	4	GENERAL INFORMATION
	877	899	921	943	MATERIAL: Metal
					MOIS. BARR: -

Four chairs nest 44" deep, each additional chair adds 8".

- Specify:
- Product Number
  - Seat Finish
  - Back Finish
  - Fabric Vendor, Pattern and Color
  - Metal Finish

See pages 16 & 17 for material and finish options.

# Delta with Arms and Casters



## 82DT25UP UPH SEAT AND BACK, ARMS, CASTERS, 18"

W: 23.5"	D: 21.5"	H: 32"	SW: 18.5"	SD: 18"	SH: 18"	AH: 25.5"	WT: 19 lb	COM: .7 yd	WT CAP: 500 lb	
ZONE	B/COM	C	D	E	F	G	H	I	J	GENERAL INFORMATION
1	1120	1134	1148	1164	1192	1220	1248	1275	1303	MATERIAL: Metal MOIS. BARR: - 1/2" SEAT FOAM: \$24
2	1148	1162	1176	1192	1220	1248	1276	1303	1331	
3	1175	1189	1203	1219	1247	1275	1303	1330	1358	
4	1203	1217	1231	1247	1275	1303	1331	1358	1386	

Price includes hard casters (for soft surfaces). Four chairs nest 44" deep, each additional chair adds 8".

## 83DT05UP UPH SEAT AND BACK, ARMS, CASTERS, 22"

W: 25.5"	D: 21.5"	H: 32"	SW: 22"	SD: 18"	SH: 18"	AH: 25.5"	WT: 22 lb	COM: .7 yd	WT CAP: 500 lb	
ZONE	B/COM	C	D	E	F	G	H	I	J	GENERAL INFORMATION
1	1202	1216	1230	1246	1274	1302	1330	1357	1385	MATERIAL: Metal MOIS. BARR: - 1/2" SEAT FOAM: \$37
2	1232	1246	1260	1276	1304	1332	1360	1387	1415	
3	1262	1276	1290	1306	1334	1362	1390	1417	1445	
4	1291	1305	1319	1335	1363	1391	1419	1446	1474	

Price includes hard casters (for soft surfaces). Four chairs nest 44" deep, each additional chair adds 8".

## 82DT25US UPH SEAT AND PLASTIC BACK, ARMS, CASTERS, 18"

W: 23.5"	D: 21.5"	H: 32"	SW: 18.5"	SD: 18"	SH: 18"	AH: 25.5"	WT: 19 lb	COM: .35 yd	WT CAP: 500 lb	
ZONE	B/COM	C	D	E	F	G	H	I	J	GENERAL INFORMATION
1	1063	1070	1076	1085	1099	1112	1126	1140	1154	MATERIAL: Metal MOIS. BARR: - 1/2" SEAT FOAM: \$24
2	1089	1096	1102	1111	1125	1138	1152	1166	1180	
3	1116	1123	1129	1138	1152	1165	1179	1193	1207	
4	1142	1149	1155	1164	1178	1191	1205	1219	1233	

Price includes hard casters (for soft surfaces). Four chairs nest 44" deep, each additional chair adds 8".

## 83DT05US UPH SEAT AND PLASTIC BACK, ARMS, CASTERS, 22"

W: 25.5"	D: 21.5"	H: 32"	SW: 22"	SD: 18"	SH: 18"	AH: 25.5"	WT: 22 lb	COM: .35 yd	WT CAP: 500 lb	
ZONE	B/COM	C	D	E	F	G	H	I	J	GENERAL INFORMATION
1	1202	1216	1230	1246	1274	1302	1330	1357	1385	MATERIAL: Metal MOIS. BARR: - 1/2" SEAT FOAM: \$37
2	1232	1246	1260	1276	1304	1332	1360	1387	1415	
3	1262	1276	1290	1306	1334	1362	1390	1417	1445	
4	1291	1305	1319	1335	1363	1391	1419	1446	1474	

Price includes hard casters (for soft surfaces). Four chairs nest 44" deep, each additional chair adds 8".

## 82DT25 PLASTIC SEAT AND BACK, ARMS, CASTERS, 18"

W: 23.5"	D: 21.5"	H: 32"	SW: 18.5"	SD: 18"	SH: 18"	AH: 25.5"	WT: 19 lb	COM: -	WT CAP: 500 lb
Zone	1	2	3	4	GENERAL INFORMATION				
	897	919	942	964	MATERIAL: Metal MOIS. BARR: -				

Price includes hard casters (for soft surfaces). Four chairs nest 44" deep, each additional chair adds 8".

## 83DT05 PLASTIC SEAT AND BACK, ARMS, CASTERS, 22"

W: 25.5"	D: 21.5"	H: 32"	SW: 22"	SD: 18"	SH: 18"	AH: 25.5"	WT: 22 lb	COM: -	WT CAP: 500 lb
Zone	1	2	3	4	GENERAL INFORMATION				
	957	981	1005	1029	MATERIAL: Metal MOIS. BARR: -				

Price includes hard casters (for soft surfaces). Four chairs nest 44" deep, each additional chair adds 8".

**Specify:**

- Product Number
- Seat Finish
- Back Finish
- Fabric Vendor, Pattern and Color
- Metal Finish

See pages 16 & 17 for material and finish options.

**Accessories**

**SOFT CASTERS (FOR HARD SURFACES)**

\$35

# Delta with Arms and Glides



## 82DT24UP UPH SEAT AND BACK, ARMS, GLIDES, 18"

W: 23.5" D: 21.5" H: 32" SW: 18.5" SD: 18" SH: 18" AH: 25.5" WT: 19 lb COM: .7 yd WT CAP: 500 lb

ZONE	B/COM	C	D	E	F	G	H	I	J	GENERAL INFORMATION
1	1120	1134	1148	1164	1192	1220	1248	1275	1303	MATERIAL: Metal MOIS. BARR: - 1/2" SEAT FOAM: \$24
2	1148	1162	1176	1192	1220	1248	1276	1303	1331	
3	1175	1189	1203	1219	1247	1275	1303	1330	1358	
4	1203	1217	1231	1247	1275	1303	1331	1358	1386	

Four chairs nest 44" deep, each additional chair adds 8".

## 83DT04UP UPH SEAT AND BACK, ARMS, GLIDES, 22"

W: 25.5" D: 21.5" H: 32" SW: 22" SD: 18" SH: 18" AH: 25.5" WT: 22 lb COM: .7 yd WT CAP: 500 lb

ZONE	B/COM	C	D	E	F	G	H	I	J	GENERAL INFORMATION
1	1202	1216	1230	1246	1274	1302	1330	1357	1385	MATERIAL: Metal MOIS. BARR: - 1/2" SEAT FOAM: \$37
2	1232	1246	1260	1276	1304	1332	1360	1387	1415	
3	1262	1276	1290	1306	1334	1362	1390	1417	1445	
4	1291	1305	1319	1335	1363	1391	1419	1446	1474	

Four chairs nest 44" deep, each additional chair adds 8".

## 82DT24US UPH SEAT AND PLASTIC BACK, ARMS, GLIDES, 18"

W: 23.5" D: 21.5" H: 32" SW: 18.5" SD: 18" SH: 18" AH: 25.5" WT: 19 lb COM: .35 yd WT CAP: 500 lb

ZONE	B/COM	C	D	E	F	G	H	I	J	GENERAL INFORMATION
1	1063	1070	1076	1085	1099	1112	1126	1140	1154	MATERIAL: Metal MOIS. BARR: - 1/2" SEAT FOAM: \$24
2	1089	1096	1102	1111	1125	1138	1152	1166	1180	
3	1116	1123	1129	1138	1152	1165	1179	1193	1207	
4	1142	1149	1155	1164	1178	1191	1205	1219	1233	

Four chairs nest 44" deep, each additional chair adds 8".

## 83DT04US UPH SEAT PLASTIC BACK, ARMS, GLIDES, 22"

W: 25.5" D: 21.5" H: 32" SW: 22" SD: 18" SH: 18" AH: 25.5" WT: 22 lb COM: .35 yd WT CAP: 500 lb

ZONE	B/COM	C	D	E	F	G	H	I	J	GENERAL INFORMATION
1	1140	1147	1153	1162	1176	1189	1203	1217	1231	MATERIAL: Metal MOIS. BARR: - 1/2" SEAT FOAM: \$37
2	1168	1175	1181	1190	1204	1217	1231	1245	1259	
3	1197	1204	1210	1219	1233	1246	1260	1274	1288	
4	1225	1232	1238	1247	1261	1274	1288	1302	1316	

Four chairs nest 44" deep, each additional chair adds 8".

## 82DT24 PLASTIC SEAT AND BACK, ARMS, GLIDES, 18"

W: 23.5" D: 21.5" H: 32" SW: 18.5" SD: 18" SH: 18" AH: 25.5" WT: 19 lb COM: - WT CAP: 500 lb

Zone	1	2	3	4	GENERAL INFORMATION
	897	919	942	964	MATERIAL: Metal MOIS. BARR: -

Four chairs nest 44" deep, each additional chair adds 8".

## 83DT04 PLASTIC SEAT AND BACK, ARMS, GLIDES, 22"

W: 25.5" D: 21.5" H: 32" SW: 22" SD: 18" SH: 18" AH: 25.5" WT: 22 lb COM: - WT CAP: 500 lb

Zone	1	2	3	4	GENERAL INFORMATION
	957	981	1005	1029	MATERIAL: Metal MOIS. BARR: -

Four chairs nest 44" deep, each additional chair adds 8".

Specify:  
 Product Number  
 Seat Finish  
 Back Finish  
 Fabric Vendor, Pattern and Color  
 Metal Finish  
**See pages 16 & 17 for material and finish options.**



**7020651 SIDE CHAIR, GSA**

W: 19.75" D: 23" H: 32.5-35.25" SW: 19.75" SD: 18.5" SH: 18-20.75" AH: - WT: 27.7 lb COM: 1.2 yd WT CAP: 300 lb

ZONE	B/COM	C	D	E	F	G	H	I	J	GENERAL INFORMATION
1	993	1017	1040	1069	1117	1164	1212	1258	1306	MATERIAL: Poly MOIS. BARR: \$6
2	1017	1041	1064	1093	1141	1188	1236	1282	1330	
3	1042	1066	1089	1118	1166	1213	1261	1307	1355	
4	1066	1090	1113	1142	1190	1237	1285	1331	1379	

Price includes casters. You must specify a carpet caster or hard-surface caster when ordering. Glides available upon request.



**7320651 ARM CHAIR, GSA**

W: 25.75" D: 23" H: 32.5-35.25" SW: 19.75" SD: 18.5" SH: 18-20.75" AH: 25-30.5" WT: 35.5 lb COM: 1.2 yd WT CAP: 300 lb

ZONE	B/COM	C	D	E	F	G	H	I	J	GENERAL INFORMATION
1	1150	1174	1197	1226	1274	1321	1369	1415	1463	MATERIAL: Poly MOIS. BARR: \$6
2	1178	1202	1225	1254	1302	1349	1397	1443	1491	
3	1207	1231	1254	1283	1331	1378	1426	1472	1520	
4	1235	1259	1282	1311	1359	1406	1454	1500	1548	

Price includes casters. You must specify a carpet caster or hard-surface caster when ordering. Glides available upon request.



**7200650 FLOOR ROCKER, GSA**

W: 19.75" D: 23" H: 25" SW: 19.75" SD: 18.5" SH: 8" AH: - WT: 14.9 lb COM: 1.2 yd WT CAP: 300 lb

ZONE	B/COM	C	D	E	F	G	H	I	J	GENERAL INFORMATION
1	592	616	639	668	716	763	811	857	905	MATERIAL: Poly MOIS. BARR: \$6
2	606	630	653	682	730	777	825	871	919	
3	621	645	668	697	745	792	840	886	934	
4	635	659	682	711	759	806	854	900	948	



**7200651 FLOOR ROCKER WITH ARMS, GSA**

W: 25.75" D: 23" H: 25" SW: 19.75" SD: 18.5" SH: 8" AH: 15-17.75" WT: 22.7 lb COM: 1.2 yd WT CAP: 300 lb

ZONE	B/COM	C	D	E	F	G	H	I	J	GENERAL INFORMATION
1	756	780	803	832	880	927	975	1021	1069	MATERIAL: Poly MOIS. BARR: \$6
2	774	798	821	850	898	945	993	1039	1087	
3	793	817	840	869	917	964	1012	1058	1106	
4	811	835	858	887	935	982	1030	1076	1124	



**7110651 BASE/TABLE, GSA**

W: 23" D: 23" H: 16.25-19" SW: - SD: - SH: - AH: - WT: 12.8 lb COM: - WT CAP: -

Zone	1	2	3	4	GENERAL INFORMATION
	489	501	513	526	MATERIAL: Poly MOIS. BARR: -

Price includes casters. You must specify a carpet caster or hard-surface caster when ordering. Glides available upon request.

Specify:

- Product Number
- Fabric Vendor, Pattern and Color
- Caster Option

See pages 16 & 17 for material and finish options.



## Chapel Furniture



## 7028730 SIDE CHAIR, UPH SEAT, UPH BARREL BACK, WOOD BACKSIDE, STACKING

W: 20" D: 22" H: 32" SW: 19.25" SD: 17" SH: 18" AH: - WT: 17 lb COM: .7 yd WT CAP: 300 lb

ZONE	B/COM	C	D	E	F	G	H	I	J	GENERAL INFORMATION
1	683	697	711	727	755	783	811	838	866	MATERIAL: Beech
2	700	714	728	744	772	800	828	855	883	MOIS. BARR: \$5
3	717	731	745	761	789	817	845	872	900	2" SEAT FOAM: \$29
4	733	747	761	777	805	833	861	888	916	

Lumbar area has fabric only, no foam.



## 7328730 ARM CHAIR, UPH SEAT, UPH BARREL BACK, WOOD BACKSIDE, STACKING

W: 22" D: 22" H: 32" SW: 19.25" SD: 17" SH: 18" AH: 25.75" WT: 19 lb COM: .7 yd WT CAP: 300 lb

ZONE	B/COM	C	D	E	F	G	H	I	J	GENERAL INFORMATION
1	839	853	867	883	911	939	967	994	1022	MATERIAL: Beech
2	860	874	888	904	932	960	988	1015	1043	MOIS. BARR: \$5
3	880	894	908	924	952	980	1008	1035	1063	2" SEAT FOAM: \$29
4	901	915	929	945	973	1001	1029	1056	1084	

Lumbar area has fabric only, no foam.



## 7028731 SIDE CHAIR, UPH SEAT, PARTIALLY UPH BARREL BACK, WOOD BACKSIDE, STACKING

W: 20" D: 22" H: 32" SW: 19.25" SD: 17" SH: 18" AH: - WT: 17 lb COM: .6 yd WT CAP: 300 lb

ZONE	B/COM	C	D	E	F	G	H	I	J	GENERAL INFORMATION
1	701	713	724	738	762	786	810	833	857	MATERIAL: Beech
2	718	730	741	755	779	803	827	850	874	MOIS. BARR: \$5
3	736	748	759	773	797	821	845	868	892	2" SEAT FOAM: \$29
4	753	765	776	790	814	838	862	885	909	



## 7328731 ARM CHAIR, UPH SEAT, PARTIALLY UPH BARREL BACK, WOOD BACKSIDE, STACKING

W: 22" D: 22" H: 32" SW: 19.25" SD: 17" SH: 18" AH: 25.75" WT: 19 lb COM: .6 yd WT CAP: 300 lb

ZONE	B/COM	C	D	E	F	G	H	I	J	GENERAL INFORMATION
1	855	867	878	892	916	940	964	987	1011	MATERIAL: Beech
2	876	888	899	913	937	961	985	1008	1032	MOIS. BARR: \$5
3	897	909	920	934	958	982	1006	1029	1053	2" SEAT FOAM: \$29
4	918	930	941	955	979	1003	1027	1050	1074	

**Specify:**

- Product Number
- Wood Finish
- Fabric Vendor, Pattern and Color

See pages 16 & 17 for material and finish options.

# Vantage SE



## 7028737 SE SIDE CHAIR, UPH SEAT, UPH BARREL BACK, WOOD BACKSIDE, STACKING

W: 20"	D: 23"	H: 32"	SW: 19.5"	SD: 18"	SH: 18.5"	AH: -	WT: 17 lb	COM: .8 yd	WT CAP: 300 lb	
ZONE	B/COM	C	D	E	F	G	H	I	J	GENERAL INFORMATION
1	754	770	785	804	836	867	899	931	963	MATERIAL: Beech
2	773	789	804	823	855	886	918	950	982	MOIS. BARR: \$5
3	791	807	822	841	873	904	936	968	1000	
4	810	826	841	860	892	923	955	987	1019	



## 7328737 SE ARM CHAIR, UPH SEAT, UPH BARREL BACK, WOOD BACKSIDE, STACKING

W: 22"	D: 23"	H: 32"	SW: 19.5"	SD: 18"	SH: 18.5"	AH: 24.75"	WT: 19 lb	COM: .8 yd	WT CAP: 300 lb	
ZONE	B/COM	C	D	E	F	G	H	I	J	GENERAL INFORMATION
1	891	907	922	941	973	1004	1036	1068	1100	MATERIAL: Beech
2	913	929	944	963	995	1026	1058	1090	1122	MOIS. BARR: \$5
3	935	951	966	985	1017	1048	1080	1112	1144	
4	957	973	988	1007	1039	1070	1102	1134	1166	



## 7028739 SE SIDE CHAIR, UPH SEAT, UPH BARREL BACK, WOOD BACKSIDE, 2" WIDER, STACKING

W: 22"	D: 23"	H: 32"	SW: 21.5"	SD: 18"	SH: 18.5"	AH: -	WT: 20 lb	COM: .8 yd	WT CAP: 300 lb	
ZONE	B/COM	C	D	E	F	G	H	I	J	GENERAL INFORMATION
1	774	790	805	824	856	887	919	951	983	MATERIAL: Beech
2	793	809	824	843	875	906	938	970	1002	MOIS. BARR: \$5
3	812	828	843	862	894	925	957	989	1021	
4	831	847	862	881	913	944	976	1008	1040	



## 7328739 SE ARM CHAIR, UPH SEAT, UPH BARREL BACK, WOOD BACKSIDE, 2" WIDER, STACKING

W: 24"	D: 23"	H: 32"	SW: 21.5"	SD: 18"	SH: 18.5"	AH: 24.75"	WT: 22 lb	COM: .8 yd	WT CAP: 300 lb	
ZONE	B/COM	C	D	E	F	G	H	I	J	GENERAL INFORMATION
1	920	936	951	970	1002	1033	1065	1097	1129	MATERIAL: Beech
2	943	959	974	993	1025	1056	1088	1120	1152	MOIS. BARR: \$5
3	965	981	996	1015	1047	1078	1110	1142	1174	
4	988	1004	1019	1038	1070	1101	1133	1165	1197	

**Specify:**

- Product Number
- Wood Finish
- Fabric Vendor, Pattern and Color

**See pages 16 & 17 for material and finish options.**

# Vantage Accessories



## 7074340 VANTAGE CHAIR ARMS

Beech \$176 WT: 2 lb



## 7070014 BOOKRACK, BACK MOUNTED

W: 14.25" D: 2.25" H: 5" WT: 1 lb

Beech \$102

For barrel back models. Cannot be used with rear-mounted cup holder accessory. Cannot be used with back mounted cup holder accessory. Cannot be used on 8731 models.



## 7070015 BOOKRACK, BACK MOUNTED, WITH COMMUNION CUP HOLDER

W: 13.5" D: 2.25" H: 5" WT: 1 lb

Beech \$110

For barrel back models. Cannot be used with rear-mounted cup holder accessory. Cannot be used with back mounted cup holder accessory.

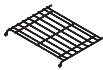

## 7074134 BOOKRACK, UNDERSEAT, WIRE

ID W: 17.25" ID D: 13" ID H: 3.5" WT: 2 lb

\$84

Cannot be used with kneeler 7094027. Use sliding kneeler or kneeler box. Not available on 2" wider SE models.

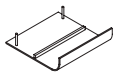

## 7074132 BOOKRACK, UNDERSEAT, REAR OPENING

ID W: 12" ID D: 8" ID H: 2.5" WT: 2 lb

Beech \$120

Cannot be used with kneeler 7094027. Use sliding kneeler or kneeler box. For use with standard width chair only.

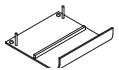

## 7074142 BOOKRACK, UNDERSEAT, REAR OPENING, WITH COMMUNION CUP HOLDER

ID W: 12" ID D: 8" ID H: 2.5" WT: 2 lb

Beech \$135

Cannot be used with kneeler 7094027. Use sliding kneeler or kneeler box. For use with standard width chair only.

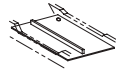

## 7074302 BOOKRACK, UNDERSEAT, FRONT AND REAR OPENING, WITH COMMUNION CUP HOLDER

ID W: 12.5" FD: 5.5" ID H: 2" RD: 7.5" \$33 WT: 2 lb

Hardwood



## 7130340 CARD AND PENCIL HOLDER, BACK MOUNTED

ID W: 3.125" ID D: 0.375" ID H: 3.25" WT: 0.5 lb

Beech \$30

For barrel back models. Cannot be used with rear-mounted bookrack.



## 7130341 3-CUP HOLDER, BACK MOUNTED

Beech \$31 WT: 0.5 lb

For barrel back models. Cannot be used with rear-mounted bookrack.



## 7130346 CARD, 2-CUP, PENCIL HOLDER, BACK MOUNTED

ID W: 3.125" ID D: 0.375" ID H: 3.25" OD H: 4"

Beech \$86 WT: 0.5 lb

For barrel back models. Cannot be used with rear-mounted bookrack.

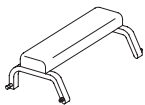

## 7094027 KNEELER, VANTAGE, UPH MOLDED FOAM PAD

W: 16.89" D: 10.5" H: 6.25" SW: - SD: - SH: - AH: - WT: 3 lb COM: .2 yd WT CAP: -

B/COM	C	D	E	F	G	H	I	J	GENERAL INFORMATION
347	351	355	360	368	376	384	391	399	MATERIAL: Beech MOIS. BARR: -

Not available on SE models. Use sliding kneeler or kneeler box.

### Specify:

- Product Number
- Wood Finish
- Fabric Vendor, Pattern and Color

See pages 16 & 17 for material and finish options.



## 2022100 SIDE CHAIR, UPH FLAT SEAT, UPH BACK, STACKING

W: 20.25" D: 20.5" H: 31.75" SW: 16.5" SD: 18.5" SH: 18" AH: - WT: 16 lb COM: .6 yd WT CAP: 300 lb

ZONE	B/COM	C	D	E	F	G	H	I	J	GENERAL INFORMATION
1	562	574	585	599	623	647	671	694	718	MATERIAL: Red Oak MOIS. BARR: \$8
2	576	588	599	613	637	661	685	708	732	
3	590	602	613	627	651	675	699	722	746	WOOD SPECIE ADDER: CHERRY .....\$67 MAPLE .....\$70 BEECH .....\$51
4	603	615	626	640	664	688	712	735	759	



## 2322102 ARM CHAIR, UPH FLAT SEAT, UPH BACK, 31 3/4" HEIGHT, STACKING

W: 23.75" D: 20.5" H: 31.75" SW: 17.5" SD: 18.5" SH: 18" AH: 25.5" WT: 18 lb COM: .6 yd WT CAP: 300 lb

ZONE	B/COM	C	D	E	F	G	H	I	J	GENERAL INFORMATION
1	761	773	784	798	822	846	870	893	917	MATERIAL: Red Oak MOIS. BARR: \$8
2	780	792	803	817	841	865	889	912	936	
3	799	811	822	836	860	884	908	931	955	WOOD SPECIE ADDER: CHERRY .....\$80 MAPLE .....\$83 BEECH .....\$61
4	817	829	840	854	878	902	926	949	973	



## 4152101 SINGLE FRONTAL KNEELER, 20 INCHES WIDE (PRIE DIEU)

W: 20.25" D: 20.75" H: 32" SW: - SD: - SH: - AH: - WT: 40 lb COM: .3 yd WT CAP: -

ZONE	B/COM	C	D	E	F	G	H	I	J	GENERAL INFORMATION
1	1069	1075	1081	1088	1100	1111	1123	1135	1147	MATERIAL: Red Oak MOIS. BARR: -
2	1096	1102	1108	1115	1127	1138	1150	1162	1174	
3	1122	1128	1134	1141	1153	1164	1176	1188	1200	WOOD SPECIE ADDER: CHERRY .....\$129 MAPLE .....\$142 BEECH .....\$203
4	1149	1155	1161	1168	1180	1191	1203	1215	1227	

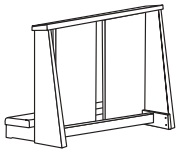

## 4152102 DOUBLE FRONTAL KNEELER, 40 INCHES WIDE (PRIE DIEU)

W: 40.25" D: 20.75" H: 31.75" SW: - SD: - SH: - AH: - WT: 66 lb COM: .4 yd WT CAP: -

ZONE	B/COM	C	D	E	F	G	H	I	J	GENERAL INFORMATION
1	1470	1478	1486	1496	1512	1527	1543	1559	1575	MATERIAL: Red Oak MOIS. BARR: -
2	1507	1515	1523	1533	1549	1564	1580	1596	1612	
3	1543	1551	1559	1569	1585	1600	1616	1632	1648	WOOD SPECIE ADDER: CHERRY .....\$179 MAPLE .....\$196 BEECH .....\$281
4	1580	1588	1596	1606	1622	1637	1653	1669	1685	

**Specify:**

- Product Number
- Wood Finish
- Fabric Vendor, Pattern and Color

**See pages 16 & 17 for material and finish options.**

# Oaklok Accessories



## 2072100 BOOKRACK, INTERLOCKING, SINGLE

L: 11.5" D: 4.5" W: 2.25" WT: 1 lb

Red Oak \$75

WOOD SPECIE ADDER: MAPLE .....\$15  
CHERRY .....\$15 BEECH .....\$9

Use with side chair only.



## 2072104 BOOKRACK, INTERLOCKING, SINGLE, EXTRA DEPTH SACK

L: 11.5" D: 9.7" W: 2.25" WT: 1 lb

Red Oak \$90

WOOD SPECIE ADDER: MAPLE .....\$13  
CHERRY .....\$13 BEECH .....\$8

Use with side chair only.



## 2072108 BOOKRACK, INTERLOCKING, DOUBLE

L: 11.5" D: 4.5" W: 5" WT: 1 lb

Red Oak \$135

WOOD SPECIE ADDER: MAPLE .....\$28  
CHERRY .....\$27 BEECH .....\$16



## 2072111 OAKLOK/PARAGON INTERLOCK, WOOD

Red Oak \$47 WT: 1 lb

WOOD SPECIE ADDER: MAPLE .....\$11  
CHERRY .....\$11 BEECH .....\$7

Use with side chair only.



## 2072118 BOOKRACK, INTERLOCKING, SINGLE, ADJUSTABLE RADIUS

L: 10.5" D: 5" W: 2.25-3" WT: 1 lb

Red Oak \$154

WOOD SPECIE ADDER: MAPLE .....\$13  
CHERRY .....\$13 BEECH .....\$8

Use with side chair only.



## 2072128 BOOKRACK, WOOD, UNDERSEAT, FRONT AND REAR OPENING, CUPHOLDER

RW: 13.38" RD: 9.25" RH: 2"  
FW: 10.75" FD: 8.25" FH: 2" WT: 2 lb

Beech \$154



## 2072131 BOOKRACK, WOOD, UNDERSEAT, REAR OPENING, CUPHOLDER

W: 13.38" D: 9.25" H: 2" WT: 2 lb

Beech \$137



## 2132101 CARD AND PENCIL HOLDER, BACK MOUNTED

H: 4" W: 3.125" D: 0.4" WT: 0.5 lb

Red Oak \$31

WOOD SPECIE ADDER: MAPLE .....\$3  
CHERRY .....\$3 BEECH .....\$2



## 2132102 CARD, 2-CUP, PENCIL HOLDER, BACK MOUNTED

H: 4" W: 3.125" D: 0.4" WT: 0.5 lb

Red Oak \$90

WOOD SPECIE ADDER: MAPLE .....\$4  
CHERRY .....\$4 BEECH .....\$3



## 2132103 3-CUP HOLDER, BACK MOUNTED

Red Oak \$36 WT: 0.5 lb

WOOD SPECIE ADDER: MAPLE .....\$2  
CHERRY .....\$2 BEECH .....\$1



## 2100 KNEELER HOLES (WITHOUT THE KNEELER) CANNOT BE ORDERED BY ITSELF

\$4

### Specify:

- Product Number
- Wood Specie
- Wood Finish

See pages 16 & 17 for material and finish options.

# Oaklok Accessories

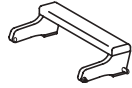

## 2090011 KNEELER, WOOD, WITH UPH MOLDED FOAM PAD

W: 17.89" D: 11" H: 6.25" SW: - SD: - SH: - AH: - WT: 5 lb COM: .2 yd WT CAP: -

B/COM	C	D	E	F	G	H	I	J	GENERAL INFORMATION
233	237	241	246	254	262	270	277	285	MATERIAL: Red Oak MOIS. BARR: -  WOOD SPECIE ADDER: CHERRY .....\$4 BEECH .....\$0 MAPLE .....\$19

Use with side chairs and 2301 arm chairs.

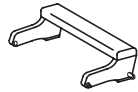

## 2090012 KNEELER, WOOD, WITH UPH MOLDED FOAM PAD

W: 18.89" D: 11" H: 6.25" SW: - SD: - SH: - AH: - WT: 5 lb COM: .2 yd WT CAP: -

B/COM	C	D	E	F	G	H	I	J	GENERAL INFORMATION
256	260	264	269	277	285	293	300	308	MATERIAL: Red Oak MOIS. BARR: -  WOOD SPECIE ADDER: CHERRY .....\$4 BEECH .....\$0 MAPLE .....\$19

Use with arm chairs except 2301 styles.

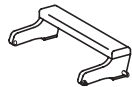

## 2090013 KNEELER, WOOD, WITH BOOKRACK, UPH MOLDED FOAM PAD

W: 17.89" D: 10" H: 6.25" SW: - SD: - SH: - AH: - WT: 4 lb COM: .2 yd WT CAP: -

B/COM	C	D	E	F	G	H	I	J	GENERAL INFORMATION
233	237	241	246	254	262	270	277	285	MATERIAL: Red Oak MOIS. BARR: -  WOOD SPECIE ADDER: CHERRY .....\$4 BEECH .....\$0 MAPLE .....\$19

Use with side chairs and 2301 arm chairs with underseat bookrack.

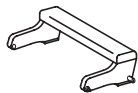

## 2090014 KNEELER, WOOD, WITH BOOKRACK, UPH MOLDED FOAM PAD

W: 18.75" D: 10" H: 6.25" SW: - SD: - SH: - AH: - WT: 4 lb COM: .2 yd WT CAP: -

B/COM	C	D	E	F	G	H	I	J	GENERAL INFORMATION
256	260	264	269	277	285	293	300	308	MATERIAL: Red Oak MOIS. BARR: -  WOOD SPECIE ADDER: CHERRY .....\$4 BEECH .....\$0 MAPLE .....\$19

Use with arm chairs with underseat bookrack except 2301 styles.

**Specify:**

- Product Number
- Wood Specie
- Wood Finish
- Fabric Vendor, Pattern and Color

**See pages 16 & 17 for material and finish options.**



### 3306120 SIDE CHAIR, UPH SEAT, WOOD BACK, NON-STACKING, 20"

W: 20" D: 23" H: 32" SW: 20" SD: 17.75" SH: 18.25" AH: - WT: 24 lb COM: .5 yd WT CAP: 300 lb

ZONE	B/COM	C	D	E	F	G	H	I	J	GENERAL INFORMATION
1	890	900	910	922	942	961	981	1001	1021	MATERIAL: Red Oak MOIS. BARR: -
2	912	922	932	944	964	983	1003	1023	1043	
3	934	944	954	966	986	1005	1025	1045	1065	WOOD SPECIE ADDER: CHERRY .....\$118 BEECH .....\$111
4	956	966	976	988	1008	1027	1047	1067	1087	MAPLE .....\$172

Fabric application is selvage front.

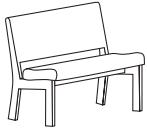

### 3306140 SIDE CHAIR, UPH SEAT, WOOD BACK, NON-STACKING, 40"

W: 40" D: 23" H: 32" SW: 40" SD: 17.75" SH: 18.25" AH: - WT: 38 lb COM: .9 yd WT CAP: 450 lb

ZONE	B/COM	C	D	E	F	G	H	I	J	GENERAL INFORMATION
1	1298	1316	1334	1355	1391	1426	1462	1497	1533	MATERIAL: Red Oak MOIS. BARR: -
2	1330	1348	1366	1387	1423	1458	1494	1529	1565	
3	1362	1380	1398	1419	1455	1490	1526	1561	1597	WOOD SPECIE ADDER: CHERRY .....\$173 BEECH .....\$180
4	1394	1412	1430	1451	1487	1522	1558	1593	1629	MAPLE .....\$240

Fabric application is selvage front.

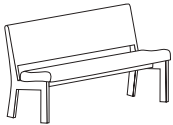

### 3306160 SIDE CHAIR, UPH SEAT, WOOD BACK, NON-STACKING, 60"

W: 60" D: 23" H: 32" SW: 60" SD: 17.75" SH: 18.25" AH: - WT: 55 lb COM: 1 yd WT CAP: 675 lb

ZONE	B/COM	C	D	E	F	G	H	I	J	GENERAL INFORMATION
1	1647	1667	1686	1710	1750	1789	1829	1868	1908	MATERIAL: Red Oak MOIS. BARR: -
2	1688	1708	1727	1751	1791	1830	1870	1909	1949	
3	1729	1749	1768	1792	1832	1871	1911	1950	1990	WOOD SPECIE ADDER: CHERRY .....\$221 BEECH .....\$242
4	1769	1789	1808	1832	1872	1911	1951	1990	2030	MAPLE .....\$301

Fabric application is selvage front.

Specify:  
 Product Number  
 Wood Specie  
 Wood Finish  
 Fabric Vendor,  
 Pattern and Color  
**See pages 16 & 17  
 for material and finish  
 options.**



### 3306420 SIDE CHAIR, UPH SEAT, BACK, AND BACKSIDE, NON-STACKING, 20"

W: 20"	D: 23"	H: 32"	SW: 20"	SD: 17"	SH: 18.25"	AH: -	WT: 24 lb	COM: 1 yd	WT CAP: 300 lb	
ZONE	B/COM	C	D	E	F	G	H	I	J	GENERAL INFORMATION
1	904	924	943	967	1007	1046	1086	1125	1165	MATERIAL: Red Oak
2	926	946	965	989	1029	1068	1108	1147	1187	MOIS. BARR: -
3	948	968	987	1011	1051	1090	1130	1169	1209	WOOD SPECIE ADDER:
4	971	991	1010	1034	1074	1113	1153	1192	1232	CHERRY .....\$113 BEECH .....\$86 MAPLE .....\$164

Fabric application is selvage front.

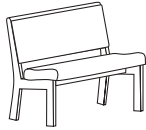

### 3306440 SIDE CHAIR, UPH SEAT, BACK, AND BACKSIDE, NON-STACKING, 40"

W: 40"	D: 23"	H: 32"	SW: 40"	SD: 17"	SH: 18.25"	AH: -	WT: 39 lb	COM: 1.8 yd	WT CAP: 450 lb	
ZONE	B/COM	C	D	E	F	G	H	I	J	GENERAL INFORMATION
1	1327	1363	1397	1440	1512	1582	1654	1725	1797	MATERIAL: Red Oak
2	1359	1395	1429	1472	1544	1614	1686	1757	1829	MOIS. BARR: -
3	1392	1428	1462	1505	1577	1647	1719	1790	1862	WOOD SPECIE ADDER:
4	1424	1460	1494	1537	1609	1679	1751	1822	1894	CHERRY .....\$162 BEECH .....\$130 MAPLE .....\$223

Fabric application is selvage front.

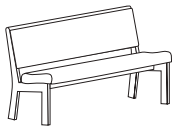

### 3306460 SIDE CHAIR, UPH SEAT, BACK, AND BACKSIDE, NON-STACKING, 60"

W: 60"	D: 23"	H: 32"	SW: 60"	SD: 17"	SH: 18.25"	AH: -	WT: 55 lb	COM: 2.2 yd	WT CAP: 675 lb	
ZONE	B/COM	C	D	E	F	G	H	I	J	GENERAL INFORMATION
1	1679	1723	1765	1818	1906	1992	2080	2165	2253	MATERIAL: Red Oak
2	1720	1764	1806	1859	1947	2033	2121	2206	2294	MOIS. BARR: -
3	1761	1805	1847	1900	1988	2074	2162	2247	2335	WOOD SPECIE ADDER:
4	1802	1846	1888	1941	2029	2115	2203	2288	2376	CHERRY .....\$204 BEECH .....\$167 MAPLE .....\$275

Fabric application is selvage front.

**Specify:**

- Product Number
- Wood Specie
- Wood Finish
- Fabric Vendor, Pattern and Color

**See pages 16 & 17 for material and finish options.**



**3306720 SIDE CHAIR, UPH SEAT AND BACK, WOOD BACKSIDE, NON-STACKING, 20"**

W: 20" D: 23" H: 32" SW: 20" SD: 17" SH: 18.25" AH: - WT: 25 lb COM: .8 yd WT CAP: 300 lb

ZONE	B/COM	C	D	E	F	G	H	I	J	GENERAL INFORMATION
1	930	946	961	980	1012	1043	1075	1107	1139	MATERIAL: Red Oak MOIS. BARR: -
2	953	969	984	1003	1035	1066	1098	1130	1162	
3	976	992	1007	1026	1058	1089	1121	1153	1185	WOOD SPECIE ADDER: CHERRY .....\$119 BEECH .....\$103
4	999	1015	1030	1049	1081	1112	1144	1176	1208	MAPLE .....\$171

Fabric application is selvage front.

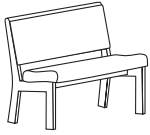

**3306740 SIDE CHAIR, UPH SEAT AND BACK, WOOD BACKSIDE, NON-STACKING, 40"**

W: 40" D: 23" H: 32" SW: 40" SD: 17" SH: 18.25" AH: - WT: 41 lb COM: 1.4 yd WT CAP: 450 lb

ZONE	B/COM	C	D	E	F	G	H	I	J	GENERAL INFORMATION
1	1349	1377	1404	1438	1494	1548	1604	1659	1715	MATERIAL: Red Oak MOIS. BARR: -
2	1382	1410	1437	1471	1527	1581	1637	1692	1748	
3	1415	1443	1470	1504	1560	1614	1670	1725	1781	WOOD SPECIE ADDER: CHERRY .....\$171 BEECH .....\$159
4	1449	1477	1504	1538	1594	1648	1704	1759	1815	MAPLE .....\$235

Fabric application is selvage front.

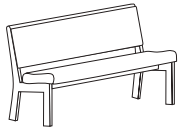

**3306760 SIDE CHAIR, UPH SEAT AND BACK, WOOD BACKSIDE, NON-STACKING, 60"**

W: 60" D: 23" H: 32" SW: 60" SD: 17" SH: 18.25" AH: - WT: 58 lb COM: 1.6 yd WT CAP: 675 lb

ZONE	B/COM	C	D	E	F	G	H	I	J	GENERAL INFORMATION
1	1700	1732	1762	1800	1864	1927	1991	2053	2117	MATERIAL: Red Oak MOIS. BARR: -
2	1742	1774	1804	1842	1906	1969	2033	2095	2159	
3	1784	1816	1846	1884	1948	2011	2075	2137	2201	WOOD SPECIE ADDER: CHERRY .....\$216 BEECH .....\$209
4	1826	1858	1888	1926	1990	2053	2117	2179	2243	MAPLE .....\$291

Fabric application is selvage front.

Specify:  
 Product Number  
 Wood Specie  
 Wood Finish  
 Fabric Vendor,  
 Pattern and Color  
**See pages 16 & 17  
 for material and finish  
 options.**

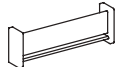

### 3080005 BOOKRACK, BACK MOUNT, 20

OD L: 16.88" OD D: 2.75" OD H: 5.88"  
 ID W: 15.25" ID D: 2.125" ID H: 4.88" WT: 1 lb  
 Red Oak \$65

WOOD SPECIE ADDER: MAPLE .....\$8  
 CHERRY .....\$2 BEECH .....\$0

For use on 20" Unity. If insert is ordered, it will be offset to one side, leaving a space of 9-1/8" to accommodate one book.

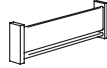

### 3080001 BOOKRACK, 3-BOOK, BACK MOUNT

OD L: 21.75" OD D: 2.75" OD H: 5.88"  
 ID W: 20.3" ID D: 2.125" ID H: 4.88" WT: 1.5 lb  
 Red Oak \$67

WOOD SPECIE ADDER: MAPLE .....\$10  
 CHERRY .....\$2 BEECH .....\$0

For use on 40" and 60" Unity. If insert is ordered, it will be placed in the middle. The remaining spaces will be 7" each. Price shown is when ordering with Unity. When ordering this accessory by itself, please refer to the pew pricing pages.



### 3080378 BOOKRACK, 4-BOOK, BACK MOUNT

OD L: 35.75" OD D: 2.75" OD H: 5.88"  
 ID W: 34" ID D: 2.187" ID H: 4.88" WT: 2 lb  
 Red Oak \$80

WOOD SPECIE ADDER: MAPLE .....\$16  
 CHERRY .....\$3 BEECH .....\$0

For use on 40" and 60" Unity. If insert is ordered, it will be placed in the middle. The remaining spaces will be 13-15/16" each. Price shown is when ordering with Unity. When ordering this accessory by itself, please refer to the pew pricing pages.



### 3080006 BOOKRACK, UNDERSEAT, REAR OPENING, 20

OD L: 14.75" OD D: 6.5" OD H: 3.125"  
 ID W: 13.125" ID D: 6.5" ID H: 2.125" WT: 1 lb  
 Red Oak \$65

WOOD SPECIE ADDER: MAPLE .....\$8  
 CHERRY .....\$1 BEECH .....\$0

For use on 20" Unity. Cannot be used with a kneeler.



### 3080007 BOOKRACK, UNDERSEAT, FRONT OPENING, 20

OD L: 14.75" OD D: 6.5" OD H: 3.125"  
 ID W: 13.125" ID D: 6.5" ID H: 2.125" WT: 1 lb  
 Red Oak \$65

WOOD SPECIE ADDER: MAPLE .....\$8  
 CHERRY .....\$1 BEECH .....\$0

For use on 20" Unity.



### 3080008 BOOKRACK, UNDERSEAT, REAR OPENING, 40/60

OD L: 34.75" OD D: 6.5" OD H: 3.5"  
 ID W: 33.125" ID D: 6.5" ID H: 2.125" WT: 2 lb  
 Red Oak \$79

WOOD SPECIE ADDER: MAPLE .....\$15  
 CHERRY .....\$3 BEECH .....\$0

For use on 40" and 60" Unity. Cannot be used with a kneeler.



### 3080009 BOOKRACK, UNDERSEAT, FRONT OPENING, 40/60

OD L: 34.75" OD D: 6.5" OD H: 31.25"  
 ID W: 33.125" ID D: 6.5" ID H: 2.125" WT: 2 lb  
 Red Oak \$79

WOOD SPECIE ADDER: MAPLE .....\$15  
 CHERRY .....\$3 BEECH .....\$0

For use on 40" and 60" Unity. Cannot be used with a kneeler.



### 3130006 INSERT, CARD, 4-CUP, PENCIL HOLDER

OD L: 6.125" OD D: 2.187" OD H: 4.125"  
 ID W: 4.125" ID D: 0.375" ID H: 4.125" WT: 0.5 lb  
 Red Oak \$30

WOOD SPECIE ADDER: MAPLE .....\$2  
 CHERRY .....\$1 BEECH .....\$0

Price shown is when ordering with Unity. When ordering this accessory by itself, please refer to the pew pricing pages.



### 3130007 INSERT, CARD & PENCIL HOLDER

OD L: 6.125" OD D: 2.187" OD H: 4.125"  
 ID W: 4.125" ID D: 0.375" ID H: 4.125" WT: 0.5 lb  
 Red Oak \$29

WOOD SPECIE ADDER: MAPLE .....\$2  
 CHERRY .....\$1 BEECH .....\$0

Price shown is when ordering with Unity. When ordering this accessory by itself, please refer to the pew pricing pages.

### 3130330 CARD, PENCIL HOLDER

OD L: 5.125" OD D: 0.75" OD H: 4.125"  
 ID W: 3.125" ID D: 0.375" ID H: 3.25" WT: 0.5 lb  
 Red Oak \$29

WOOD SPECIE ADDER: MAPLE .....\$2  
 CHERRY .....\$1 BEECH .....\$0

Cannot be used with a back-mounted bookrack on a 20" seat unit or with a 3080378 bookrack on a 40" unit. Price shown is when ordering with Unity. When ordering this accessory by itself, please refer to the pew pricing pages.

### 3130336 CARD, 3-CUP, PENCIL HOLDER

OD L: 5.125" OD D: 2.125" OD H: 4.125"  
 ID W: 3.125" ID D: 0.375" ID H: 3.25" WT: 0.5 lb  
 Red Oak \$40

WOOD SPECIE ADDER: MAPLE .....\$3  
 CHERRY .....\$1 BEECH .....\$0

Cannot be used with a back-mounted bookrack on a 20" seat unit or with a 3080378 bookrack on a 40" unit.

### 3170001 INTERLOCK

\$7 WT: 0.5 lb

Cannot be used with Unity arm models.

### 3170002 ANCHOR SET (SET OF FOUR)

\$12 WT: 0.5 lb

Cannot be used with stacking units. Includes 4" anchors.



### 2100 KNEELER HOLES (WITHOUT THE KNEELER) CANNOT BE ORDERED BY ITSELF

\$4

**Specify:**

- Product Number
- Wood Specie
- Wood Finish

See pages 16 & 17 for material and finish options.

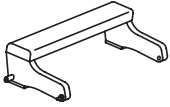

### 3090015 KNEELER, WOOD, UPH MOLDED FOAM PAD, 20"

W: 17.25" D: 11.25" H: 6.25" SW: - SD: - SH: - AH: - WT: 5 lb COM: .2 yd WT CAP: -

B/COM	C	D	E	F	G	H	I	J	GENERAL INFORMATION
210	214	218	223	231	239	247	254	262	MATERIAL: Red Oak MOIS. BARR: -  WOOD SPECIE ADDER: CHERRY .....\$4 BEECH .....\$0 MAPLE .....\$18

Cannot be used with underseat rear-mounted bookracks.

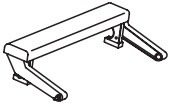

### 3090016 KNEELER, METAL, UPH MOLDED FOAM PAD, 20"

W: 17.25" D: 10.5" H: 6.75" SW: - SD: - SH: - AH: - WT: 5 lb COM: .2 yd WT CAP: -

B/COM	C	D	E	F	G	H	I	J	GENERAL INFORMATION
201	205	209	214	222	230	238	245	253	MATERIAL: Metal MOIS. BARR: -

Cannot be used with underseat rear mounted bookracks or stacking models. For non-stacking 20" seat.

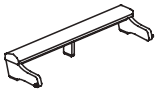

### 3090017 KNEELER, WOOD, UPH MOLDED FOAM PAD, 40"

W: 37.25" D: 11.25" H: 6.25" SW: - SD: - SH: - AH: - WT: 10 lb COM: .4 yd WT CAP: -

B/COM	C	D	E	F	G	H	I	J	GENERAL INFORMATION
334	342	350	360	376	391	407	423	439	MATERIAL: Red Oak MOIS. BARR: -  WOOD SPECIE ADDER: CHERRY .....\$5 BEECH .....\$0 MAPLE .....\$27

Cannot be used with underseat rear-mounted bookracks.



### 3090018 KNEELER, METAL, UPH MOLDED FOAM PAD, 40"

W: 37.25" D: 10.5" H: 6.75" SW: - SD: - SH: - AH: - WT: 10 lb COM: .4 yd WT CAP: -

B/COM	C	D	E	F	G	H	I	J	GENERAL INFORMATION
304	312	320	330	346	361	377	393	409	MATERIAL: Metal MOIS. BARR: -

Cannot be used with underseat rear mounted bookracks or stacking models.



### 3090019 KNEELER, WOOD, UPH MOLDED FOAM PAD, 60"

W: 57.25" D: 11.25" H: 6.25" SW: - SD: - SH: - AH: - WT: 15 lb COM: .5 yd WT CAP: -

B/COM	C	D	E	F	G	H	I	J	GENERAL INFORMATION
418	428	438	450	470	489	509	529	549	MATERIAL: Red Oak MOIS. BARR: -  WOOD SPECIE ADDER: CHERRY .....\$7 BEECH .....\$0 MAPLE .....\$34

Cannot be used with underseat rear-mounted bookracks.



### 3090020 KNEELER, METAL, UPH MOLDED FOAM PAD, 60"

W: 57.25" D: 10.5" H: 6.75" SW: - SD: - SH: - AH: - WT: 15 lb COM: .5 yd WT CAP: -

B/COM	C	D	E	F	G	H	I	J	GENERAL INFORMATION
380	390	400	412	432	451	471	491	511	MATERIAL: Metal MOIS. BARR: -

Cannot be used with underseat rear-mounted bookracks. Cannot be used with stacking units.

- Specify:
- Product Number
  - Wood Specie
  - Wood Finish
  - Fabric Vendor, Pattern and Color

See pages 16 & 17 for material and finish options.

# Chancel

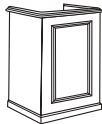

## 4111305 COLONIAL LECTERN, WITH ROUT, STAINED, 23"W X 30"L X 45"H

W: 23" D: 30" H: 45" WT: 115 lb

Zone	1	2	3	4
	6587	6752	6916	7081

### GENERAL INFORMATION

MATERIAL: Red Oak  
MOIS BARR: -

WOOD SPECIE ADDER:  
CHERRY .....\$111 BEECH .....\$277  
MAPLE .....\$304

Please note Chancel items require an extended lead time. Call for details. Additional wood species are available, including: Rift Red Oak, White Oak, White Oak Rift, Beech, Cherry, Maple, Mahogany, and Walnut. Call for details. Also available in a painted finish, use product number 4111705.

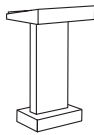

## 4112083 LECTERN, ADJUSTABLE HEIGHT, 19"W X 24"L X 44-47"H

W: 19" D: 24" H: 44-47" WT: 50 lb

Zone	1	2	3	4
	3472	3559	3646	3732

### GENERAL INFORMATION

MATERIAL: Red Oak  
MOIS BARR: -

WOOD SPECIE ADDER:  
CHERRY .....\$60 BEECH .....\$150  
MAPLE .....\$165

Please note Chancel items require an extended lead time. Call for details. Additional wood species are available, including: Rift Red Oak, White Oak, White Oak Rift, Beech, Cherry, Maple, Mahogany, and Walnut. Call for details. Non-locking casters are available.

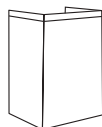

## 4113100 TRADITIONAL LECTERN, 23"W X 30"L X 45"H

W: 23" D: 30" H: 45" WT: 120 lb

Zone	1	2	3	4
	3203	3283	3363	3443

### GENERAL INFORMATION

MATERIAL: Red Oak  
MOIS BARR: -

WOOD SPECIE ADDER:  
CHERRY .....\$55 BEECH .....\$138  
MAPLE .....\$152

Please note Chancel items require an extended lead time. Call for details. Additional wood species are available, including: Rift Red Oak, White Oak, White Oak Rift, Beech, Cherry, Maple, Mahogany, and Walnut. Call for details.



## 4041305 COLONIAL COMMUNION TABLE, WITH ROUT, STAINED, 30"W X 60"L X 30"H

W: 30" D: 60" H: 30" WT: 115 lb

Zone	1	2	3	4
	7131	7309	7488	7666

### GENERAL INFORMATION

MATERIAL: Red Oak  
MOIS BARR: -

WOOD SPECIE ADDER:  
CHERRY .....\$120 BEECH .....\$300  
MAPLE .....\$329

Please note Chancel items require an extended lead time. Call for details. Also available in a painted finish, use product number 4041705. Additional wood species are available, including: Rift Red Oak, White Oak, White Oak Rift, Beech, Cherry, Maple, Mahogany, and Walnut. Call for details.

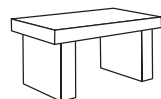

## 4043100 TRADITIONAL COMMUNION TABLE, 30"W X 60"L X 30"H

W: 30" D: 60" H: 30" WT: 115 lb

Zone	1	2	3	4
	4421	4532	4642	4753

### GENERAL INFORMATION

MATERIAL: Red Oak  
MOIS BARR: -

WOOD SPECIE ADDER:  
CHERRY .....\$76 BEECH .....\$191  
MAPLE .....\$210

Please note Chancel items require an extended lead time. Call for details. Additional wood species are available, including: Rift Red Oak, White Oak, White Oak Rift, Beech, Cherry, Maple, Mahogany, and Walnut. Call for details.



## 4081305 COLONIAL FLOWER STAND, WITH ROUT, STAINED, 11 1/2"W X 11 1/2"L X 24"H

W: 11.5" D: 11.5" H: 24" WT: 30 lb

Zone	1	2	3	4
	2806	2876	2946	3016

### GENERAL INFORMATION

MATERIAL: Red Oak  
MOIS BARR: -

WOOD SPECIE ADDER:  
CHERRY .....\$47 BEECH .....\$118  
MAPLE .....\$130

Please note Chancel items require an extended lead time. Call for details. Also available in a painted finish, use product number 4081705. Additional wood species are available, including: Rift Red Oak, White Oak, White Oak Rift, Beech, Cherry, Maple, Mahogany, and Walnut. Call for details.

#### Specify:

- Product Number
- Wood Specie
- Wood Finish

See pages 16 & 17 for material and finish options.



## 4083100 TRADITIONAL FLOWER STAND, 11 1/2"W X 11 1/2"L X 24"H

W: 11.5" D: 11.5" H: 24" WT: 35 lb

Zone	1	2	3	4
	1663	1705	1746	1788

### GENERAL INFORMATION

MATERIAL: Red Oak  
MOIS BARR: -

WOOD SPECIE ADDER:  
CHERRY .....\$29 BEECH .....\$72  
MAPLE .....\$79

Please note Chancel items require an extended lead time. Call for details. Additional wood species are available, including: Rift Red Oak, White Oak, White Oak Rift, Beech, Cherry, Maple, Mahogany, and Walnut. Call for details.



## 4083600 TRADITIONAL FLOWER STAND, 11 1/2"W X 11 1/2"L X 24"H

W: 11.5" D: 11.5" H: 24" WT: 25 lb

Zone	1	2	3	4
	2271	2328	2385	2441

### GENERAL INFORMATION

MATERIAL: Red Oak  
MOIS BARR: -

WOOD SPECIE ADDER:  
CHERRY .....\$39 BEECH .....\$98  
MAPLE .....\$108

Please note Chancel items require an extended lead time. Call for details. Additional wood species are available, including: Rift Red Oak, White Oak, White Oak Rift, Beech, Cherry, Maple, Mahogany, and Walnut. Call for details.

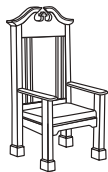

## 4321305 COLONIAL CLERGY ARM CHAIR, 25 1/8"W X 19 1/4"L X 42"H

W: 25.13" D: 19.25" H: 42" SW: - SD: - SH: - AH: - WT: 45 lb COM: 1.25 yd WT CAP: -

ZONE	B/COM	C	D	E	F	G	H	I	J
1	6705	6730	6754	6784	6834	6883	6933	6981	7031
2	6872	6897	6921	6951	7001	7050	7100	7148	7198
3	7039	7064	7088	7118	7168	7217	7267	7315	7365
4	7206	7231	7255	7285	7335	7384	7434	7482	7532

### GENERAL INFORMATION

MATERIAL: Red Oak  
MOIS. BARR: -

WOOD SPECIE ADDER:  
CHERRY .....\$112 BEECH .....\$281  
MAPLE .....\$309

Please note Chancel items require an extended lead time. Call for details. Also available in a painted finish, use product number 4321705. Additional wood species are available, including: Rift Red Oak, White Oak, White Oak Rift, Beech, Cherry, Maple, Mahogany, and Walnut. Call for details.

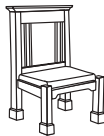

## 4021305 COLONIAL CLERGY SIDE CHAIR, STAINED, 25 1/8"W X 19 1/4"L X 39"H

W: 25.13" D: 19.25" H: 39" SW: - SD: - SH: - AH: - WT: 37 lb COM: 1.25 yd WT CAP: -

ZONE	B/COM	C	D	E	F	G	H	I	J
1	5529	5554	5578	5608	5658	5707	5757	5805	5855
2	5667	5692	5716	5746	5796	5845	5895	5943	5993
3	5804	5829	5853	5883	5933	5982	6032	6080	6130
4	5942	5967	5991	6021	6071	6120	6170	6218	6268

### GENERAL INFORMATION

MATERIAL: Red Oak  
MOIS. BARR: -

WOOD SPECIE ADDER:  
CHERRY .....\$93 BEECH .....\$231  
MAPLE .....\$255

Please note Chancel items require an extended lead time. Call for details. Also available in a painted finish, use product number 4021705. Additional wood species are available, including: Rift Red Oak, White Oak, White Oak Rift, Beech, Cherry, Maple, Mahogany, and Walnut. Call for details.

#### Specify:

- Product Number
- Wood Specie
- Wood Finish
- Fabric Vendor, Pattern and Color

See pages 16 & 17 for material and finish options.

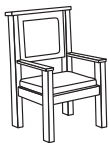

## 4232100 TRADITIONAL CLERGY ARM CHAIR, 25 1/8"W X 19 1/4"L X 42"H

W: 25.13" D: 19.25" H: 42" SW: - SD: - SH: - AH: - WT: 30 lb COM: 1.25 yd WT CAP: -

ZONE	B/COM	C	D	E	F	G	H	I	J	GENERAL INFORMATION
1	3790	3815	3839	3869	3919	3968	4018	4066	4116	MATERIAL: Red Oak
2	3884	3909	3933	3963	4013	4062	4112	4160	4210	MOIS. BARR: -
3	3978	4003	4027	4057	4107	4156	4206	4254	4304	WOOD SPECIE ADDER:
4	4073	4098	4122	4152	4202	4251	4301	4349	4399	CHERRY .....\$65 BEECH .....\$163 MAPLE .....\$179

Please note Chancel items require an extended lead time. Call for details. Additional wood species are available, including: Rift Red Oak, White Oak, White Oak Rift, Beech, Cherry, Maple, Mahogany, and Walnut. Call for details.



## 4023100 TRADITIONAL CLERGY SIDE CHAIR, 25 1/8"W X 19 1/4"L X 39"H

W: 25.13" D: 19.25" H: 39" SW: - SD: - SH: - AH: - WT: 30 lb COM: 1.25 yd WT CAP: -

ZONE	B/COM	C	D	E	F	G	H	I	J	GENERAL INFORMATION
1	3496	3521	3545	3575	3625	3674	3724	3772	3822	MATERIAL: Red Oak
2	3583	3608	3632	3662	3712	3761	3811	3859	3909	MOIS. BARR: -
3	3670	3695	3719	3749	3799	3848	3898	3946	3996	WOOD SPECIE ADDER:
4	3757	3782	3806	3836	3886	3935	3985	4033	4083	CHERRY .....\$60 BEECH .....\$150 MAPLE .....\$165

Please note Chancel items require an extended lead time. Call for details. Additional wood species are available, including: Rift Red Oak, White Oak, White Oak Rift, Beech, Cherry, Maple, Mahogany, and Walnut. Call for details.

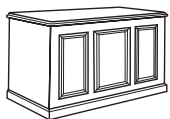

## 4011305 COLONIAL ALTAR, CLOSED, WITH ROUT, STAINED, 30"W X 72"L X 39"H

W: 30" D: 72" H: 39" WT: 220 lb

Zone	1	2	3	4
	8970	9194	9418	9643

### GENERAL INFORMATION

MATERIAL: Red Oak  
MOIS BARR: -

WOOD SPECIE ADDER:  
CHERRY .....\$151 BEECH .....\$377  
MAPLE .....\$414

Please note Chancel items require an extended lead time. Call for details. Also available in a painted finish, use product number 4011705. Additional wood species are available, including: Rift Red Oak, White Oak, White Oak Rift, Beech, Cherry, Maple, Mahogany, and Walnut. Call for details.

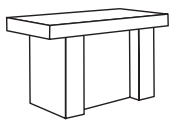

## 4013100 TRADITIONAL ALTAR, CLOSED, 30"W X 72"L X 39"H

W: 30" D: 72" H: 39" WT: 195 lb

Zone	1	2	3	4
	6949	7123	7296	7470

### GENERAL INFORMATION

MATERIAL: Red Oak  
MOIS BARR: -

WOOD SPECIE ADDER:  
CHERRY .....\$120 BEECH .....\$300  
MAPLE .....\$330

Please note Chancel items require an extended lead time. Call for details. Additional wood species are available, including: Rift Red Oak, White Oak, White Oak Rift, Beech, Cherry, Maple, Mahogany, and Walnut. Call for details.

#### Specify:

- Product Number
- Wood Specie
- Wood Finish
- Fabric Vendor, Pattern and Color

See pages 16 & 17 for material and finish options.

# Additional Chapel Product Accessories



## 7094031 KNEELER, SLIDING, UPH MOLDED FOAM PAD

W: 14.4" D: 20.6" H: 6.25" SW: - SD: - SH: - AH: - WT: 4 lb COM: .2 yd WT CAP: -

B/COM	C	D	E	F	G	H	I	J	GENERAL INFORMATION
307	311	315	320	328	336	344	351	359	MATERIAL: Beech MOIS. BARR: -

Fits Horizon, Laurelwood, Plylok, Wedgewood and Vantage SE.

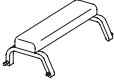

## 7094038 KNEELER, PLYLOK, UPH MOLDED FOAM PAD

W: 16.25" D: 11.25" H: 6.25" SW: - SD: - SH: - AH: - WT: 3 lb COM: .2 yd WT CAP: -

B/COM	C	D	E	F	G	H	I	J	GENERAL INFORMATION
347	351	355	360	368	376	384	391	399	MATERIAL: Beech MOIS. BARR: -

**Specify:**

- Product Number
- Wood Specie
- Wood Finish
- Fabric Vendor, Pattern and Color

**See pages 16 & 17 for material and finish options.**

# Additional Chapel Product Accessories



## 7074105 BOOKRACK, BACK MOUNTED

ID W: 12.75" ID D: 2.5" ID H: 5" WT: 2 lb  
\$141

For use with standard width chair only. Cannot be used with rear-mounted cup holder accessory. Cannot be used with back mounted cup holder accessory.



## 7074132 BOOKRACK, UNDERSEAT, REAR OPENING

ID W: 12" ID D: 8" ID H: 2.5" WT: 2 lb  
\$120

Cannot be used with kneeler 7094027. Use sliding kneeler or kneeler box. For use with standard width chair only.



## 7074152 BOOKRACK, UNDERSEAT, FRONT OPENING

ID W: 12" ID D: 8" ID H: 2.38" WT: 2 lb  
\$115

Cannot be used with a kneeler. For use with standard width chair only.



## 7074162 BOOKRACK, UNDERSEAT, FRONT AND REAR OPENING

RW: 12" RD: 8" RH: 2.5"  
FW: 10.75" FD: 5.75" FH: 2.25" WT: 2 lb  
\$146

Cannot be used with kneeler 7094027. Use sliding kneeler or kneeler box. For use with standard width chair only.



## 7074303 BOOKRACK, UNDERSEAT, REAR OPENING, WITH COMMUNION CUP

ID W: 12" ID D: 7.5" ID H: 2.25" WT: 2 lb  
\$33

For use with standard width chair only. Hardwood.



## 7144014 T MOLD RUNNER (SET OF TWO)

\$43 WT: 0.5 lb

Available for 2- and 3-position and sledbase chairs.



## 7130356 CARD, 2-CUP, PENCIL HOLDER, BACK MOUNTED

ID W: 3.125" ID D: 0.375" ID H: 3.25" WT: 0.5 lb  
\$97

Cannot be used with a back mounted bookrack or on ladder backs.

## 7032000 UNIVERSAL 2-WHEEL CART

W: -	D: -	H: -	WT: 37 lb
Zone 1	Zone 2	Zone 3	Zone 4
\$1188	\$1218	\$1247	\$1277

Cart holds 8 side chairs and 7 arm chairs.



## 7074129 INTERLOCK, METAL, STRAIGHT

\$8 WT: 0.5 lb

Female interlock is mounted on right leg. Male interlock is mounted on left leg. See chair reference chart below for more information on usage.



## 7074130 INTERLOCK, METAL, RADIUS

\$47 WT: 0.5 lb

Female interlock is mounted on right leg. Male interlock is mounted on left leg. See chair reference chart below for more information on usage.

Interlock Reference Chart						
Chair	7074129 Straight			7074130 Radius		
	S to S	S to A	A to A	S to S	S to A	A to A
Oaklok**	Yes*	No	No	Yes	No*	No
PlyFold	Yes	-	-	No	-	-
PlyLok	Yes	No	No	Yes	Yes	Yes
Unity non-stacking***	Yes	No	No	Yes	No	No
Unity stacking	Yes	No	No	No	No	No
Vantage****	Yes	Yes	Yes	Yes	Yes	No
Vantage SE****	Yes	Yes	Yes	Yes	Yes	No

### GLIDES:

Available for Oaklok, PlyFold, PlyLok, Unity®, Vantage, Vantage SE

### STRAIGHT INTERLOCKS:

Available for Oaklok, PlyFold, 4-leg PlyLok, Unity®, Vantage

### RADIUS INTERLOCKS:

Available for Oaklok, 4-leg PlyLok, PlyLok "L" arm chairs, Unity®, Vantage

**Please Note:** Different product lines are not intended to be interlocked with each other.

S to S = Can be used to attach a side chair to a side chair.  
S to A = Can be used to attach a side chair to an arm chair.  
A to A = Can be used to attach an arm chair to an arm chair.

\*Requires a PMR

\*\*Oaklok requires two sets per chair.

\*\*\*On non-stacking Unity the min. radius is 3 feet.

\*\*\*\*Vantage Arm chairs with interlocks cannot stack more than 2 chairs high.

### Specify:

Product Number

Wood Finish

See pages 16 & 17 for material and finish options.



**WIELAND**  
healthcare

10785 Rose Ave.  
New Haven, IN 46774

888.WIELAND  
[wielandhealthcare.com](http://wielandhealthcare.com)

©2026 Sauder Manufacturing Co.

HC04061012